

15 Van Haeren Street

Ground Floor

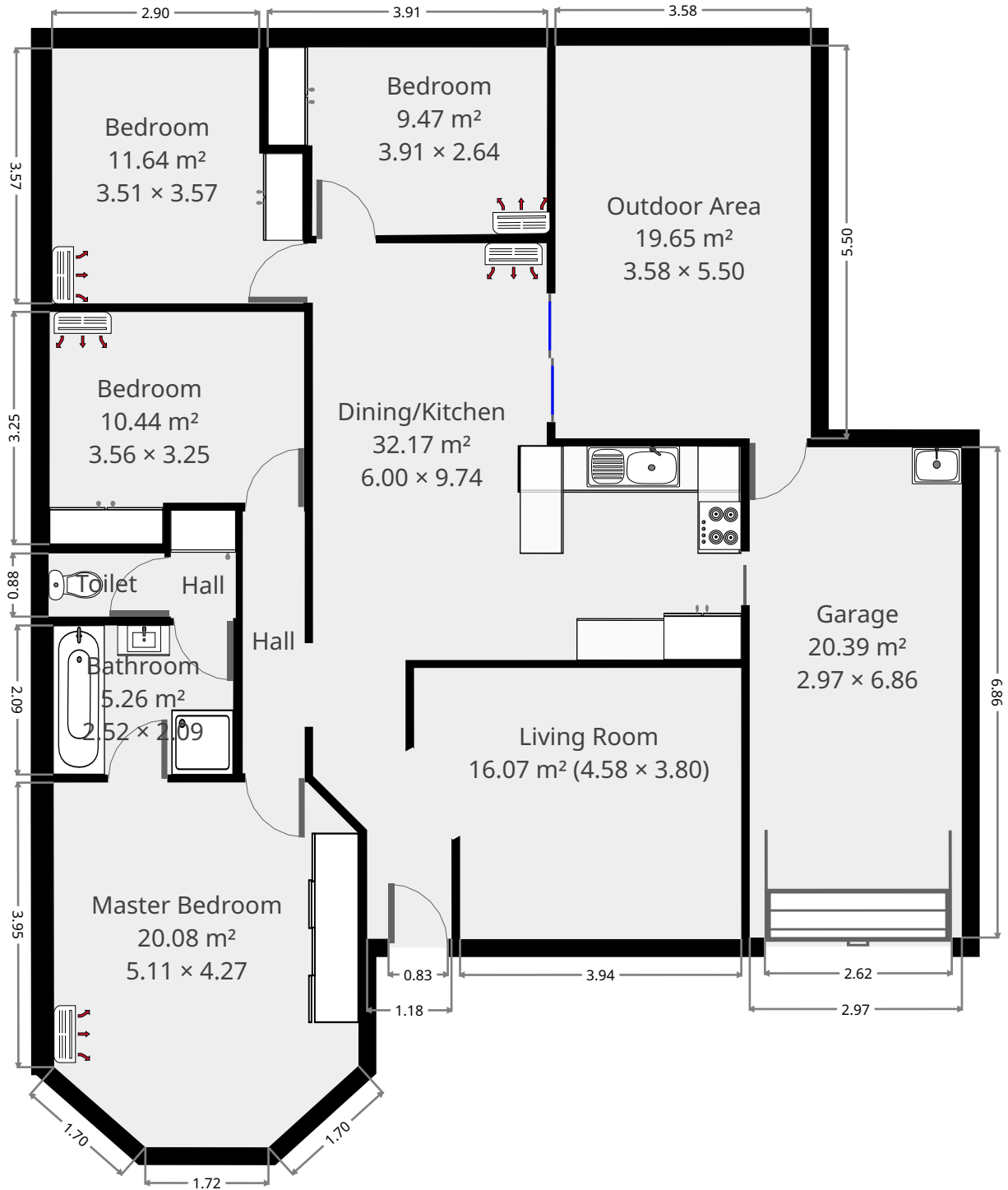

THIS FLOORPLAN IS PROVIDED WITHOUT WARRANTY OF ANY KIND. SENSOPIA DISCLAIMS ANY WARRANTY INCLUDING, WITHOUT LIMITATION, SATISFACTORY QUALITY OR ACCURACY OF DIMENSIONS.

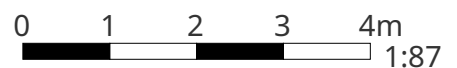

15 Van Haeren Street

Dining/Kitchen

Width: 6.00 m
 Length: 9.74 m
 Area: 32.17 m²
 Perimeter: 31.82 m

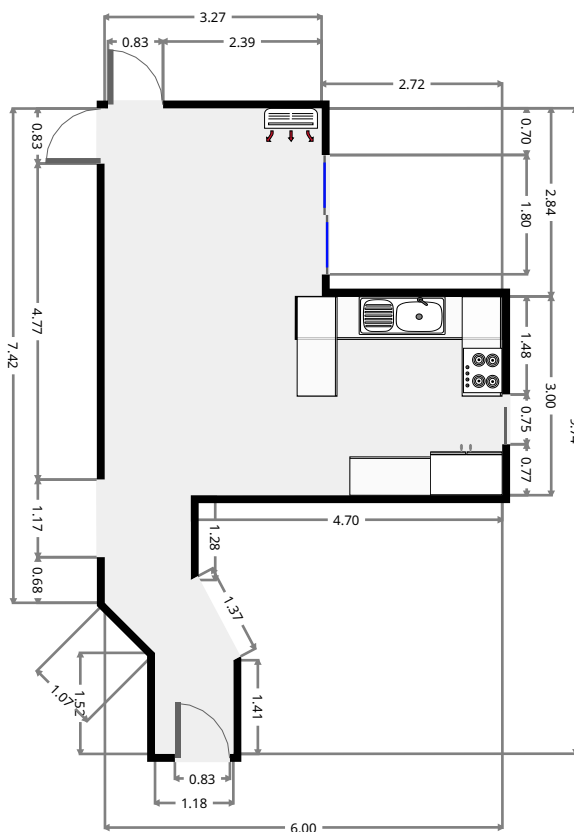
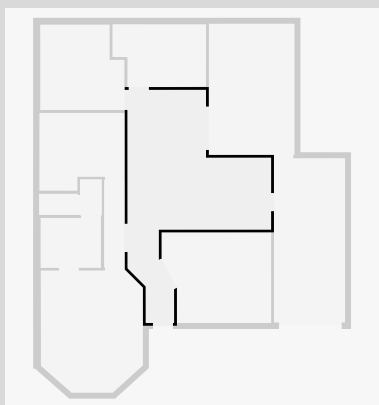

Living Room

Width: 3.80 m
 Length: 4.58 m
 Area: 16.07 m²
 Perimeter: 16.27 m

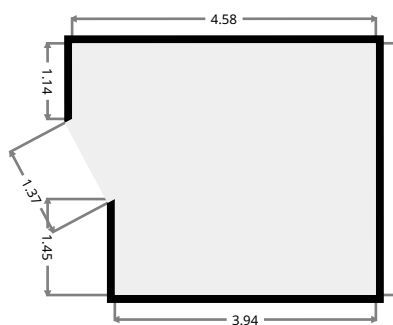
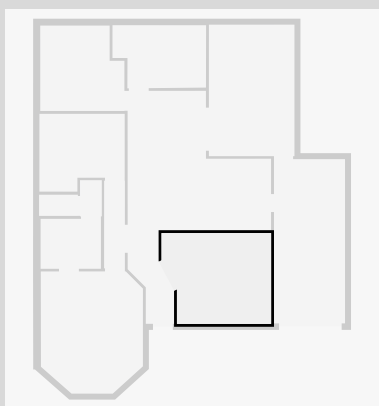

15 Van Haeren Street

Hall

Width: 0.87 m
Length: 3.66 m
Area: 3.18 m²
Perimeter: 9.07 m

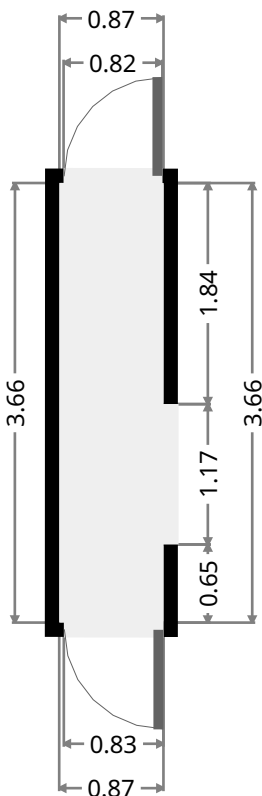
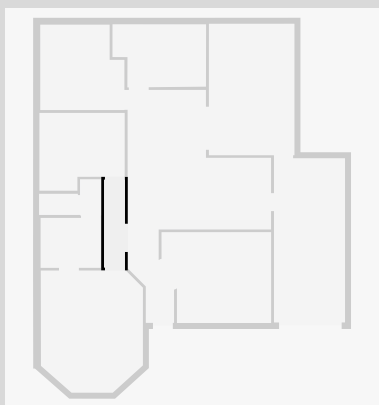

Bedroom

Width: 3.25 m
Length: 3.56 m
Area: 10.44 m²
Perimeter: 13.63 m

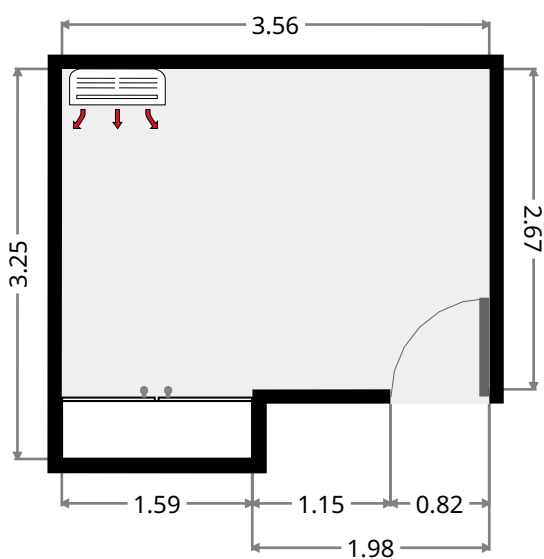
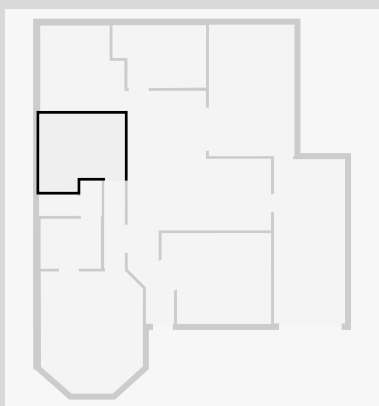

15 Van Haeren Street

Hall

Width: 0.92 m
Length: 1.51 m
Area: 1.38 m²
Perimeter: 4.85 m

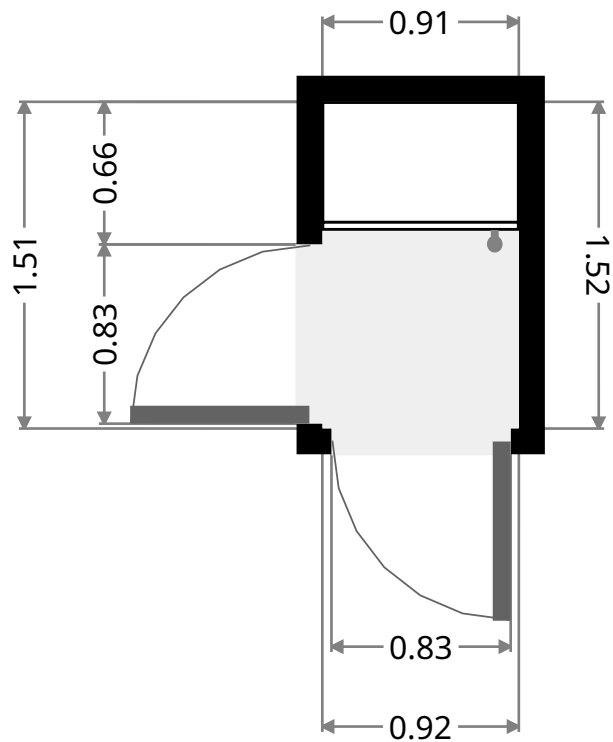
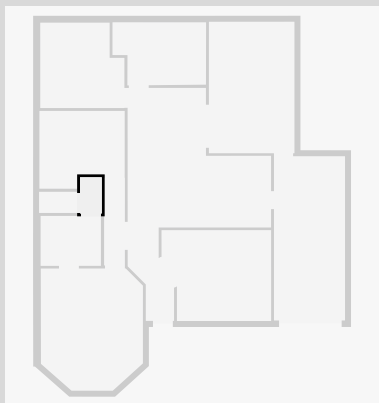

Toilet

Width: 0.88 m
Length: 1.62 m
Area: 1.43 m²
Perimeter: 5.01 m

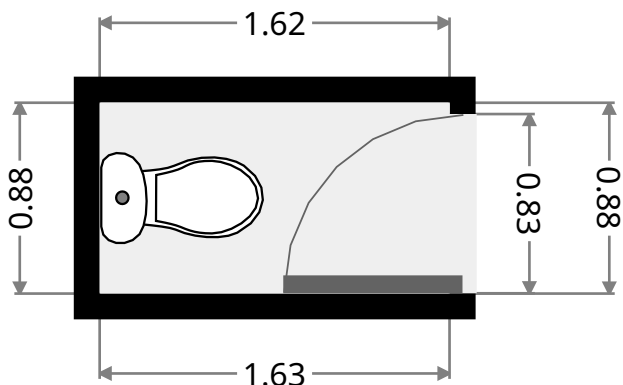
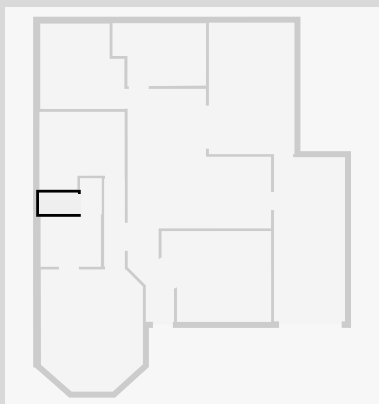

15 Van Haeren Street

Bathroom

Width: 2.09 m
Length: 2.52 m
Area: 5.26 m²
Perimeter: 9.21 m

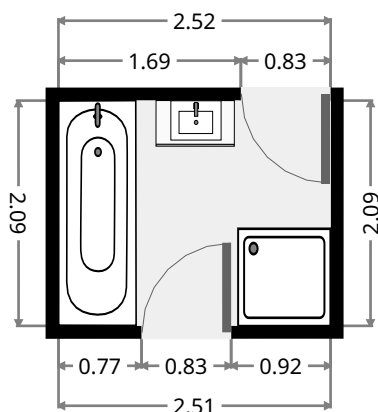
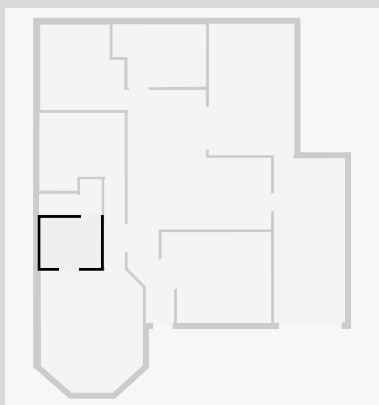

Master Bedroom

Width: 4.27 m
Length: 5.11 m
Area: 20.08 m²
Perimeter: 16.92 m

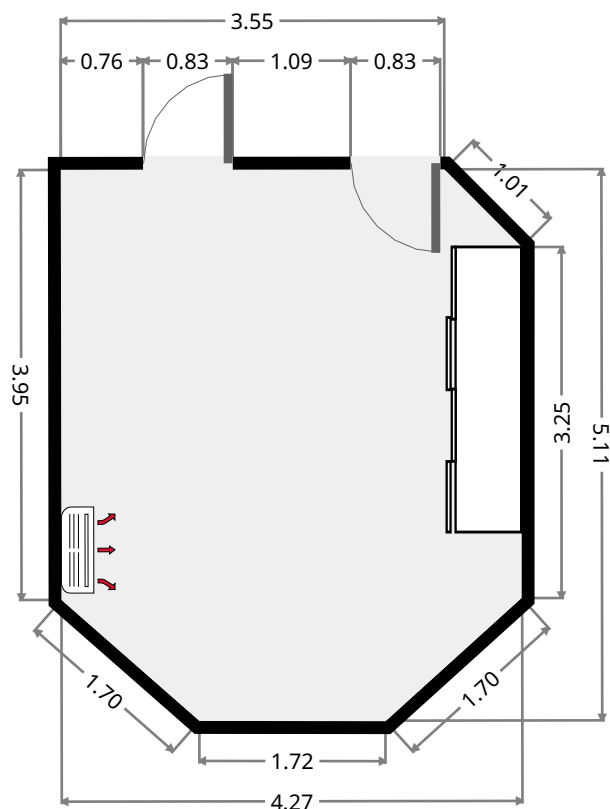
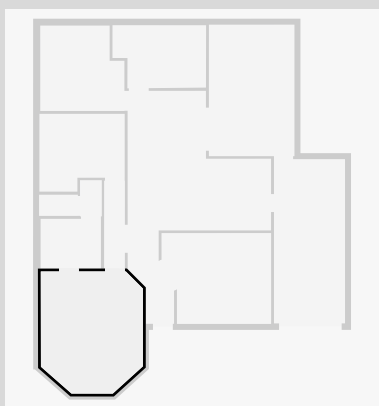

THIS FLOORPLAN IS PROVIDED WITHOUT WARRANTY OF ANY KIND. SENSOPIA DISCLAIMS ANY WARRANTY INCLUDING, WITHOUT LIMITATION, SATISFACTORY QUALITY OR ACCURACY OF DIMENSIONS.

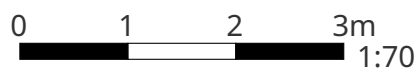

15 Van Haeren Street

Bedroom

Width: 3.51 m
 Length: 3.57 m
 Area: 11.64 m²
 Perimeter: 14.17 m

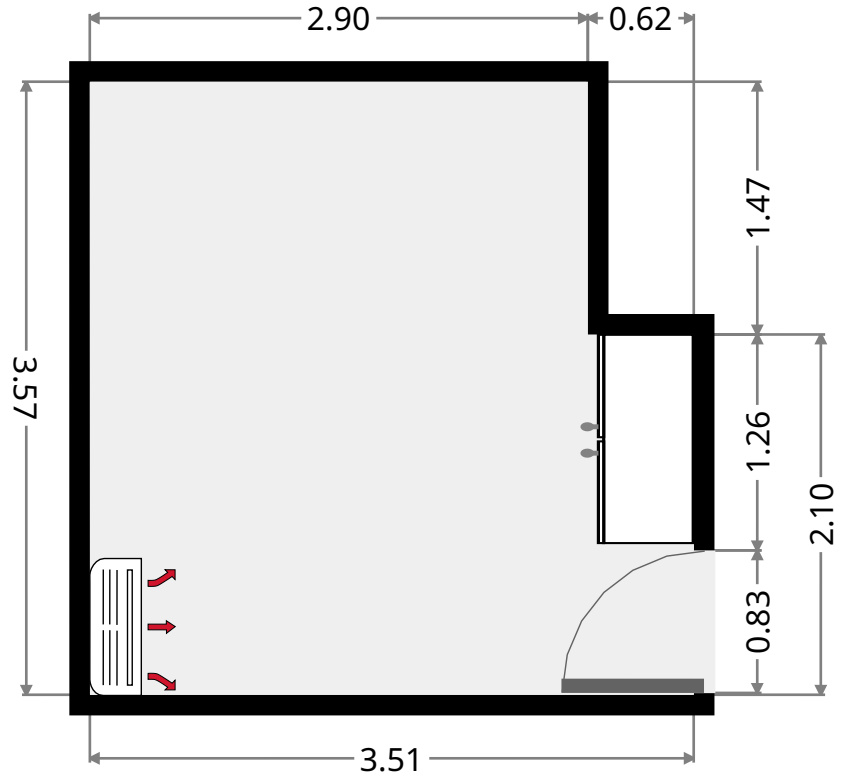
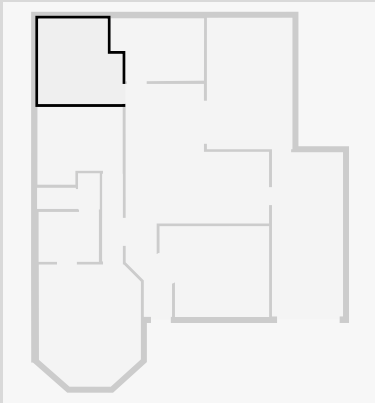

Bedroom

Width: 2.64 m
 Length: 3.91 m
 Area: 9.47 m²
 Perimeter: 13.07 m

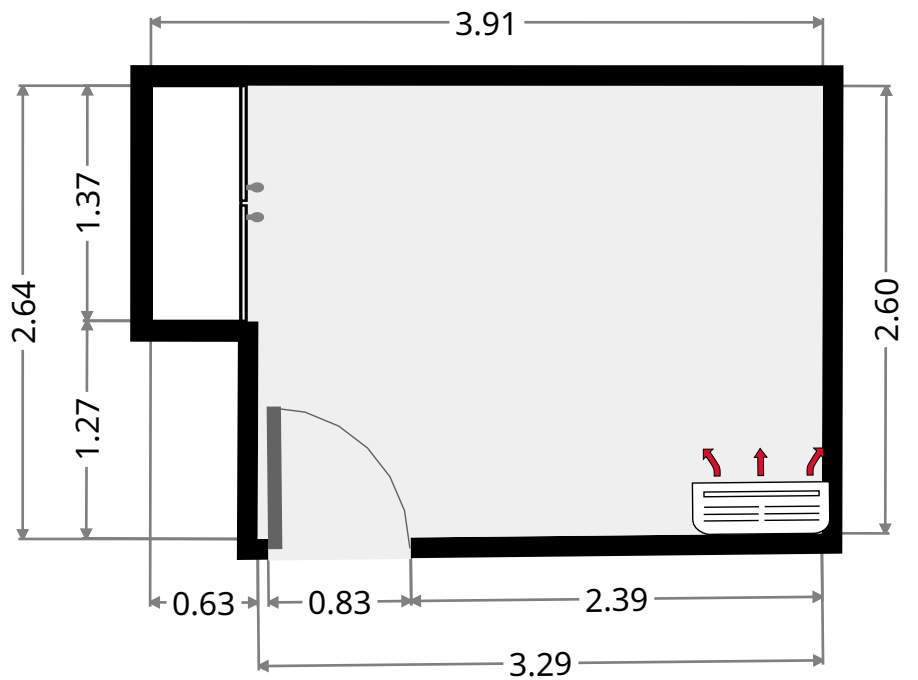
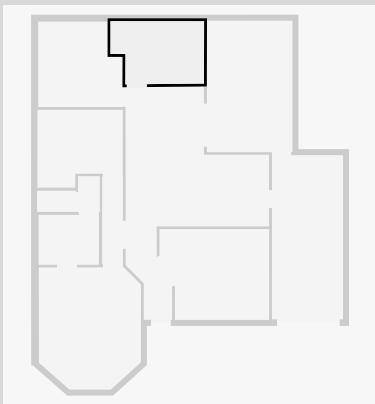

THIS FLOORPLAN IS PROVIDED WITHOUT WARRANTY OF ANY KIND. SENSOPIA DISCLAIMS ANY WARRANTY INCLUDING, WITHOUT LIMITATION, SATISFACTORY QUALITY OR ACCURACY OF DIMENSIONS.

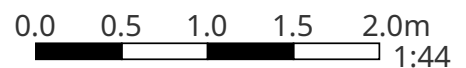

15 Van Haeren Street

Outdoor Area

Width: 3.58 m
Length: 5.50 m
Area: 19.65 m²
Perimeter: 18.14 m

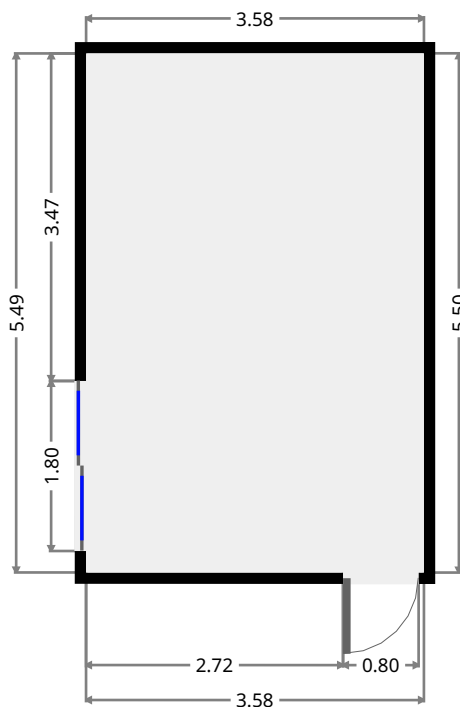
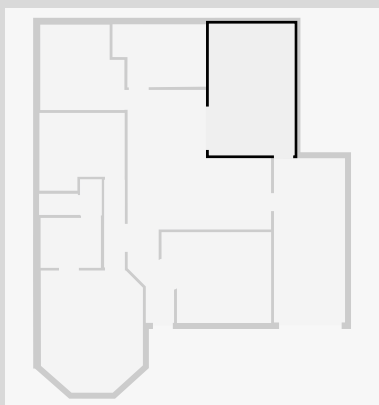

Garage

Width: 2.97 m
Length: 6.86 m
Area: 20.39 m²
Perimeter: 19.67 m

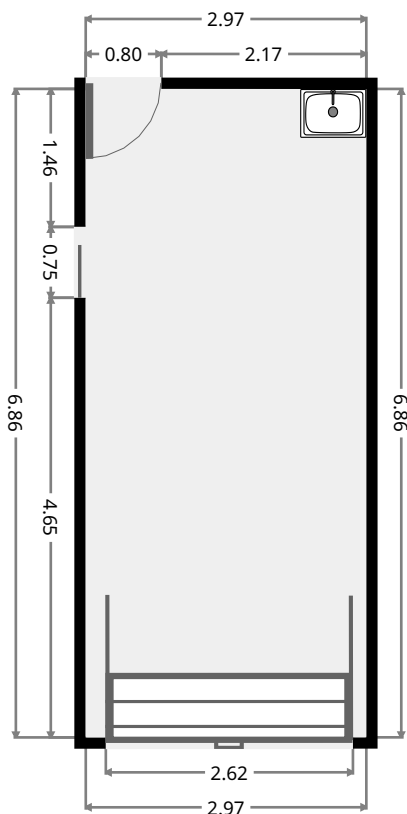
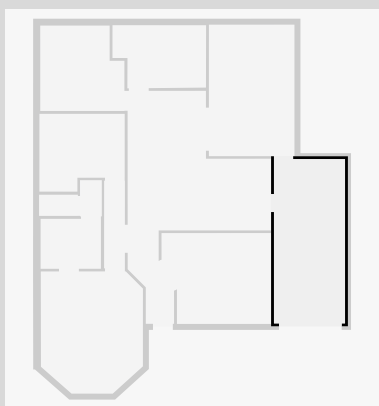

THIS FLOORPLAN IS PROVIDED WITHOUT WARRANTY OF ANY KIND. SENSOPIA DISCLAIMS ANY WARRANTY INCLUDING, WITHOUT LIMITATION, SATISFACTORY QUALITY OR ACCURACY OF DIMENSIONS.

