

15 Sunrise Crescent

Created on
2020-11-24

Floors
2

▼ Ground Floor



FLOORS:2

▼ **Living Room**
Ground Floor

WIDTH:5.70 m · LENGTH:7.00 m
AREA:39.90 m² · PERIMETER:25.40 m

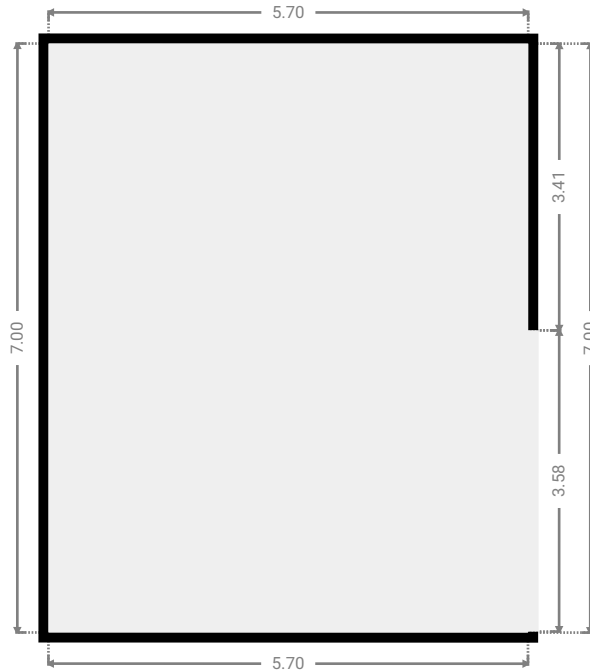
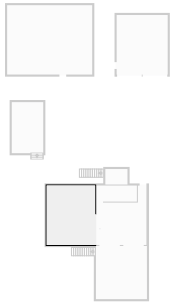

▼ **Living Room**
Ground Floor

WIDTH:5.90 m · LENGTH:6.85 m
AREA:31.39 m² · PERIMETER:25.76 m

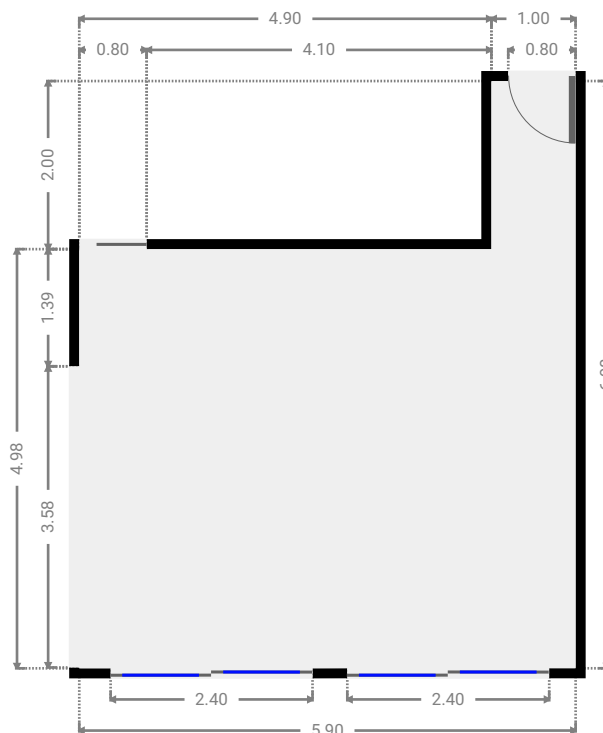
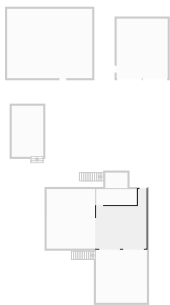

▼ Laundry Room Ground Floor

WIDTH:4.78 m · LENGTH:1.90 m
AREA:9.02 m² · PERIMETER:13.33 m

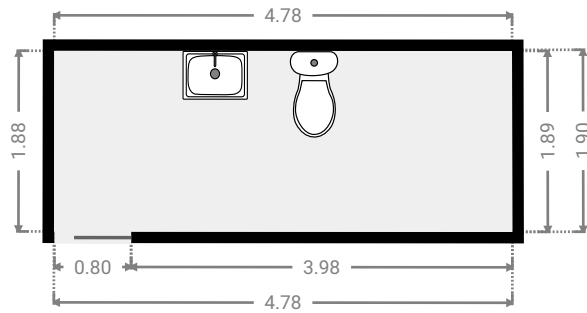
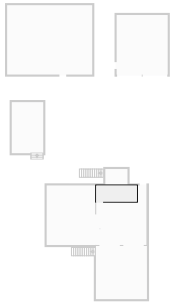

▼ Other Ground Floor

WIDTH:6.00 m · LENGTH:6.25 m
AREA:37.46 m² · PERIMETER:24.49 m

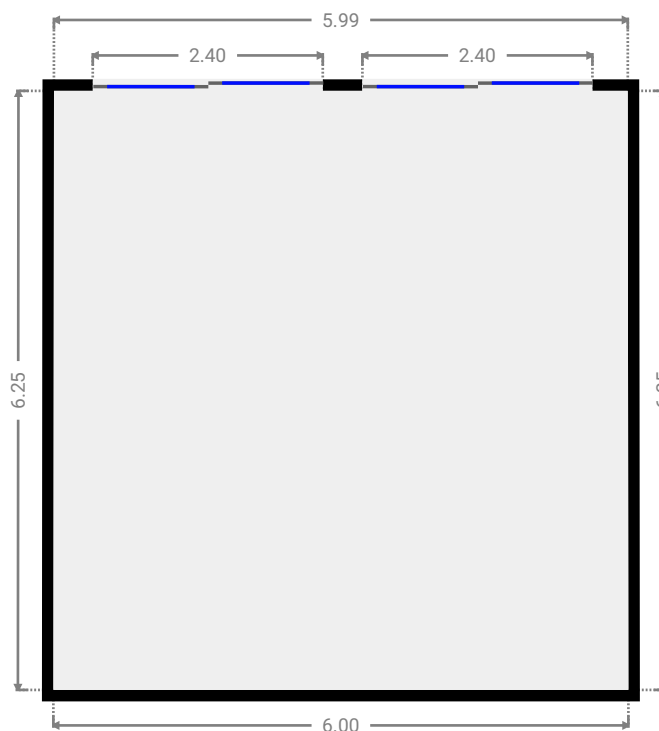
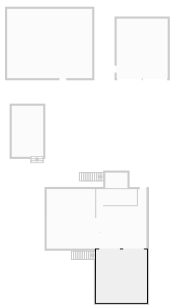

FLOORS:2

▼ Other

Ground Floor

WIDTH:2.60 m · LENGTH:1.82 m
AREA:4.73 m² · PERIMETER:8.84 m

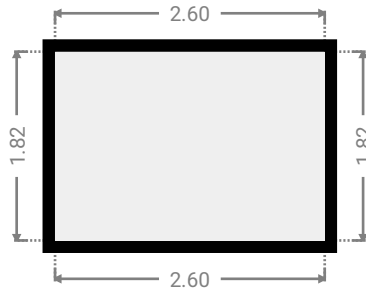
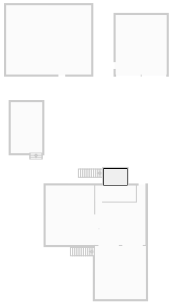

▼ Other

Ground Floor

WIDTH:3.70 m · LENGTH:6.00 m
AREA:22.20 m² · PERIMETER:19.40 m

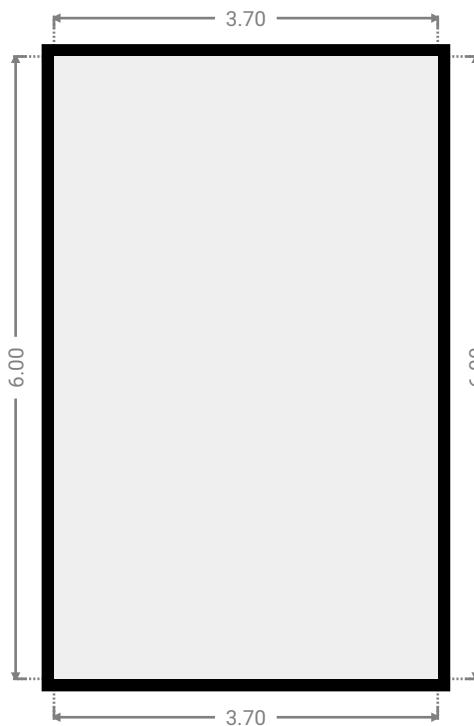
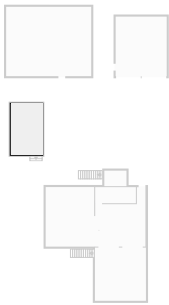

▼ Other
Ground Floor

WIDTH:10.00 m · LENGTH:8.15 m
AREA:81.50 m² · PERIMETER:36.30 m

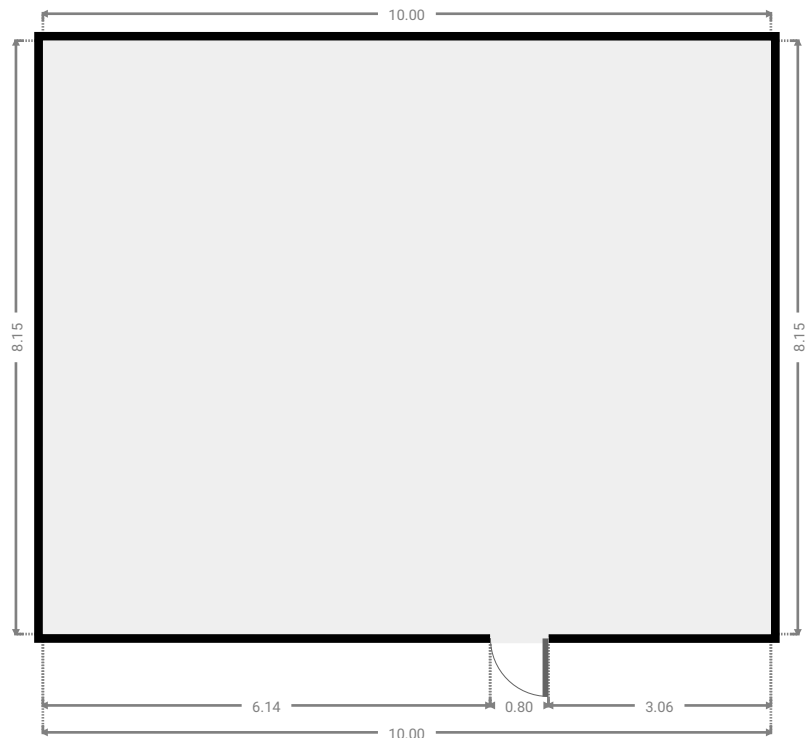
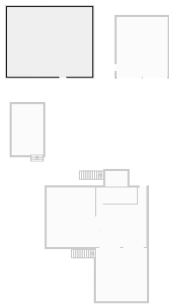

▼ Other
Ground Floor

WIDTH:6.00 m · LENGTH:7.00 m
AREA:42.00 m² · PERIMETER:26.00 m

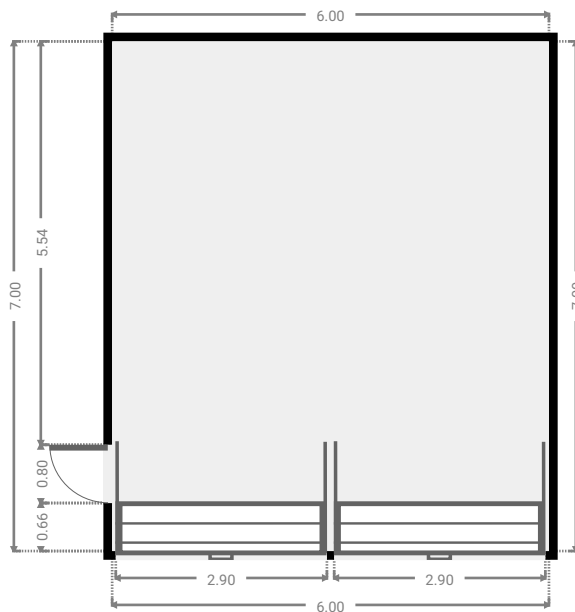
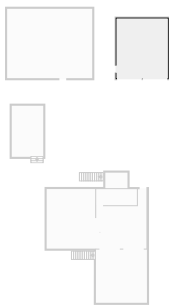

▼ 1st Floor

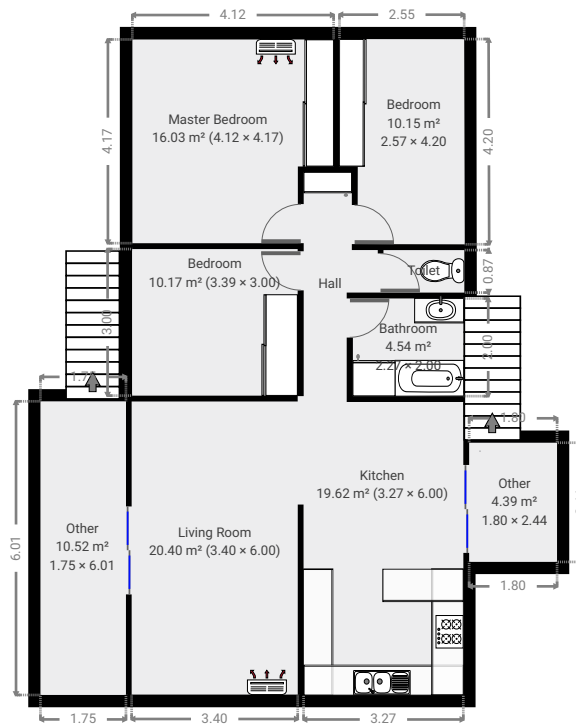

▼ Living Room 1st Floor

WIDTH:6.00 m · LENGTH:3.40 m
AREA:20.40 m² · PERIMETER:18.80 m

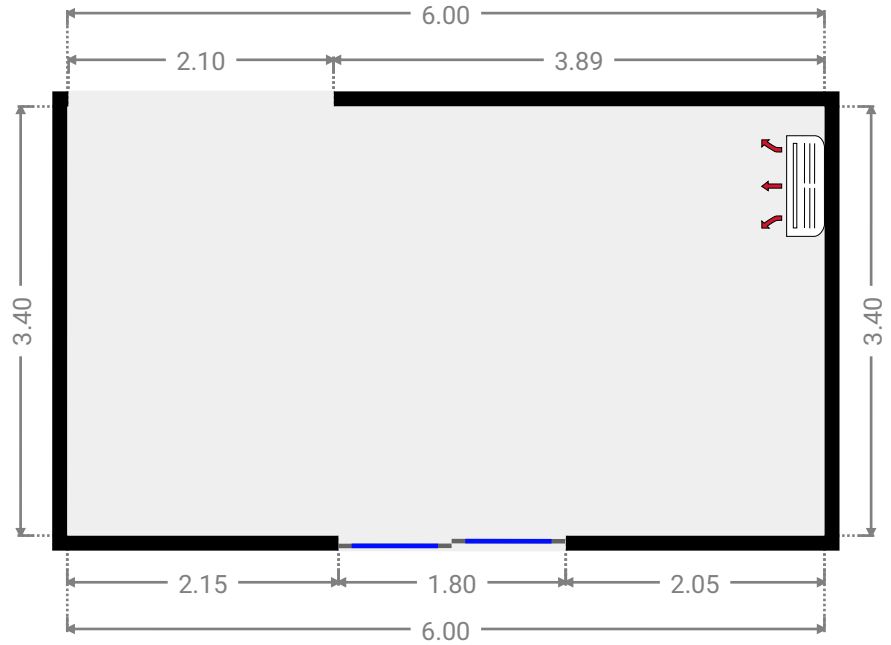
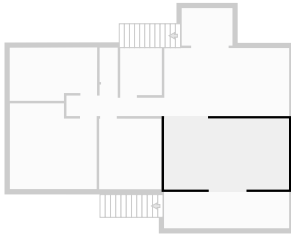

▼ Kitchen 1st Floor

WIDTH:6.00 m · LENGTH:3.27 m
AREA:19.62 m² · PERIMETER:18.54 m

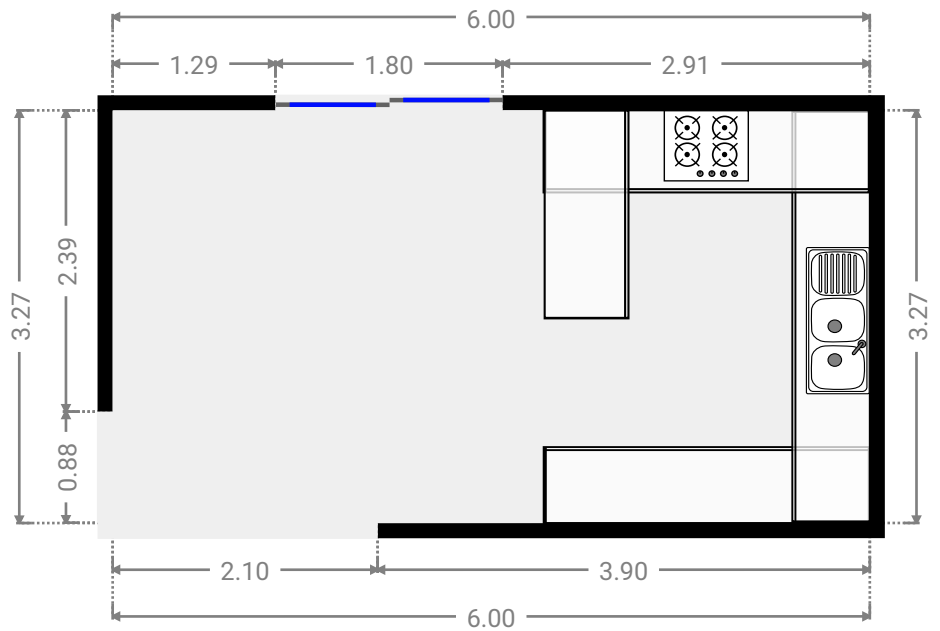
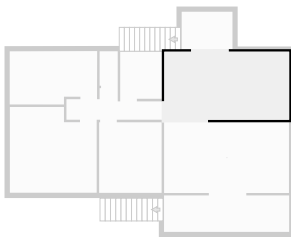

FLOORS:2

▼ **Hall**
1st Floor

WIDTH:4.58 m · LENGTH:1.52 m
AREA:4.75 m² · PERIMETER:12.19 m

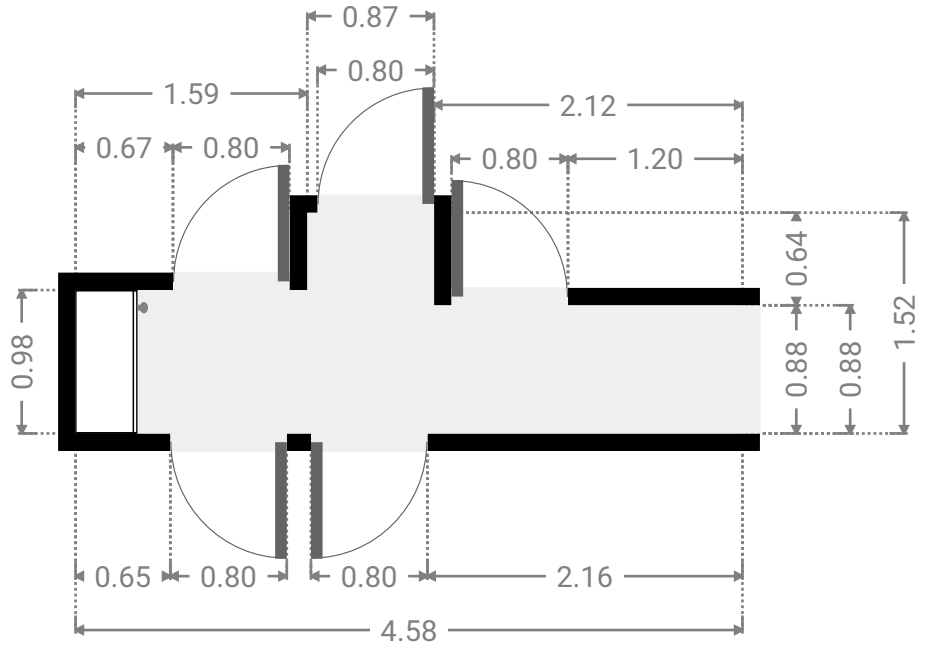
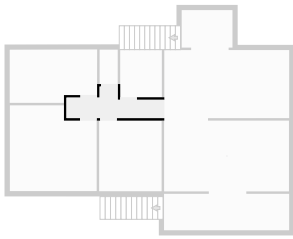

▼ **Bathroom**
1st Floor

WIDTH:2.00 m · LENGTH:2.27 m
AREA:4.54 m² · PERIMETER:8.54 m

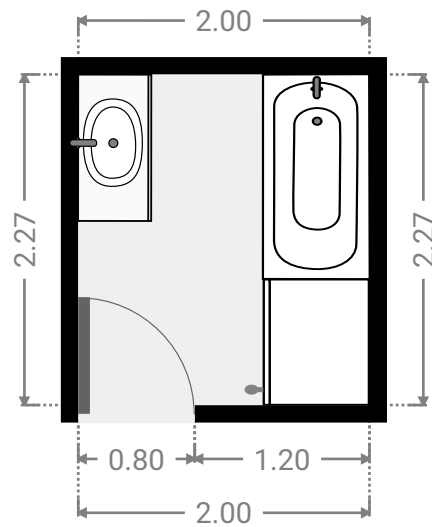
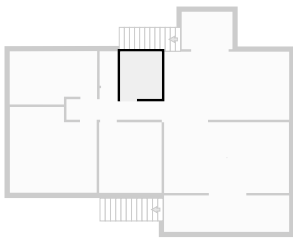

▼ Toilet
1st Floor

WIDTH:0.87 m · LENGTH:1.66 m
AREA:1.44 m² · PERIMETER:5.05 m

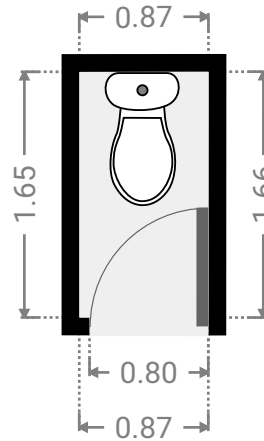
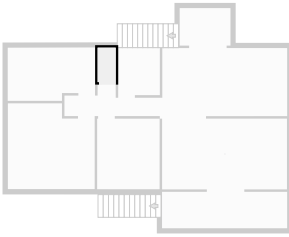

▼ Bedroom
1st Floor

WIDTH:3.00 m · LENGTH:3.39 m
AREA:10.17 m² · PERIMETER:12.78 m

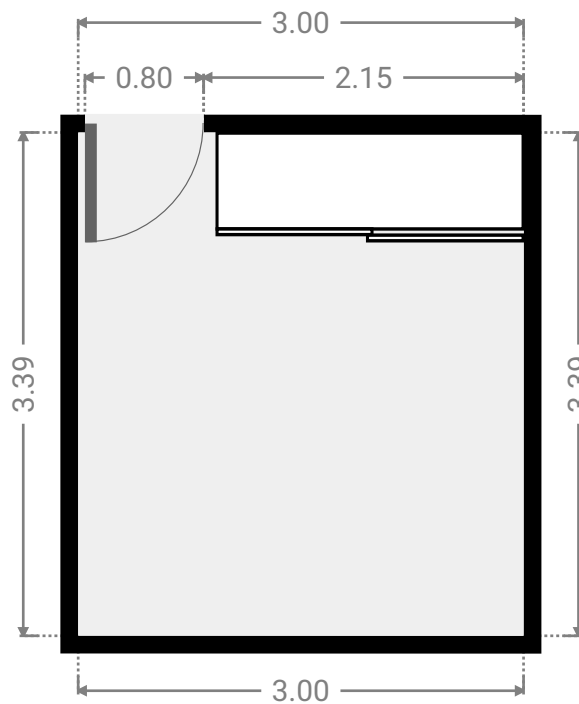
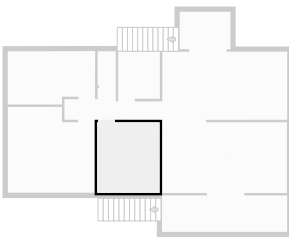

FLOORS:2

▼ Master Bedroom 1st Floor

WIDTH:4.17 m · LENGTH:4.12 m
AREA:16.03 m² · PERIMETER:16.58 m

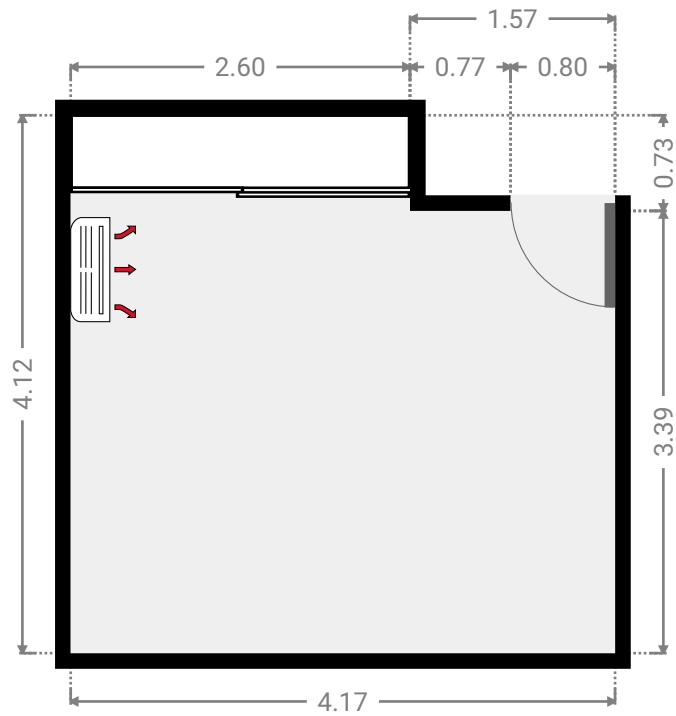
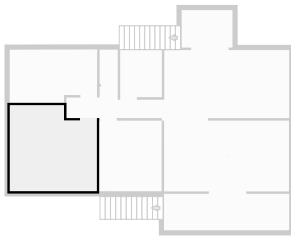

▼ Bedroom 1st Floor

WIDTH:4.20 m · LENGTH:2.57 m
AREA:10.15 m² · PERIMETER:13.52 m

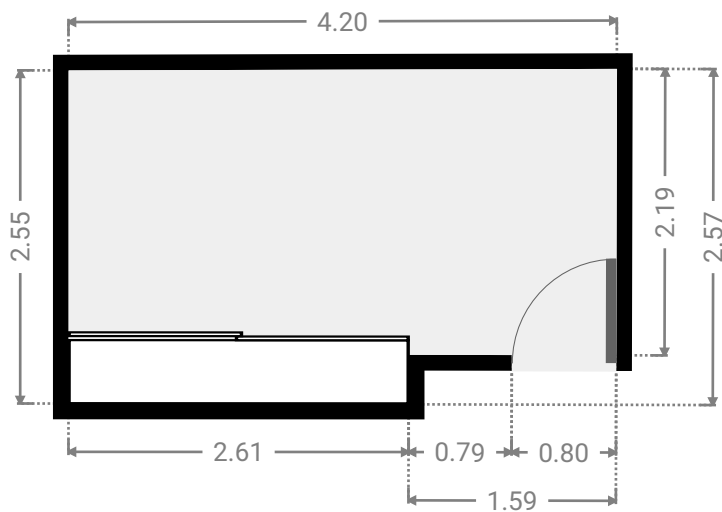
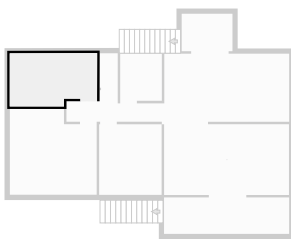

▼ Other
1st Floor

WIDTH:6.01 m · LENGTH:1.75 m
AREA:10.52 m² · PERIMETER:15.52 m

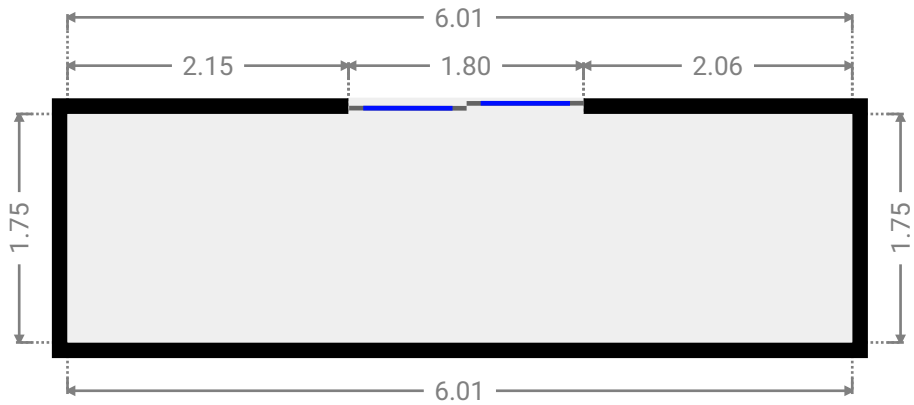
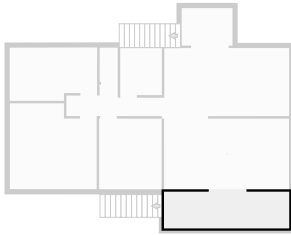

▼ Other
1st Floor

WIDTH:2.44 m · LENGTH:1.80 m
AREA:4.39 m² · PERIMETER:8.48 m

