

15 Madison Avenue

Created on
2021-05-27

Floors
1

▼ Ground Floor

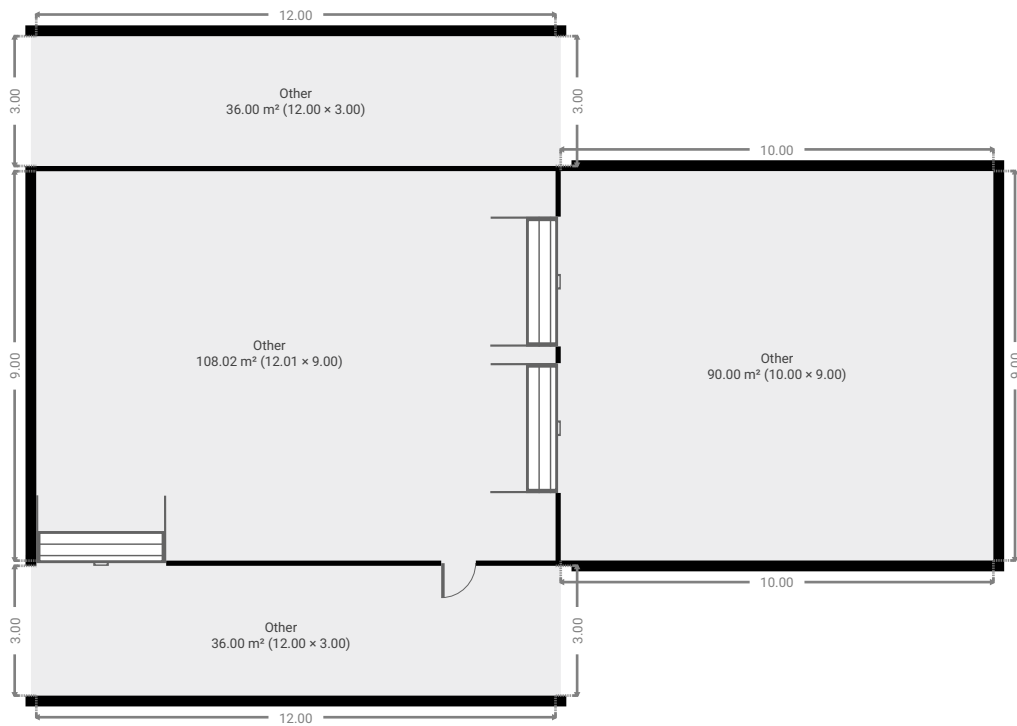

▼ Bathroom
Ground Floor

WIDTH: 3.05 m • LENGTH: 2.08 m
AREA: 6.34 m² • PERIMETER: 10.26 m

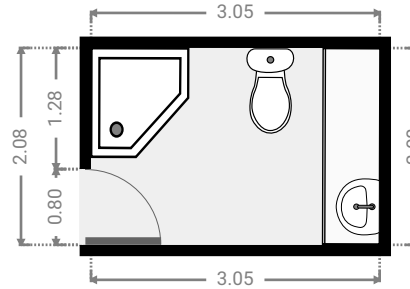
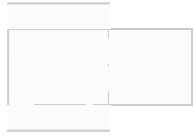

▼ Other
Ground Floor

WIDTH: 6.83 m • LENGTH: 4.82 m
AREA: 32.92 m² • PERIMETER: 23.30 m

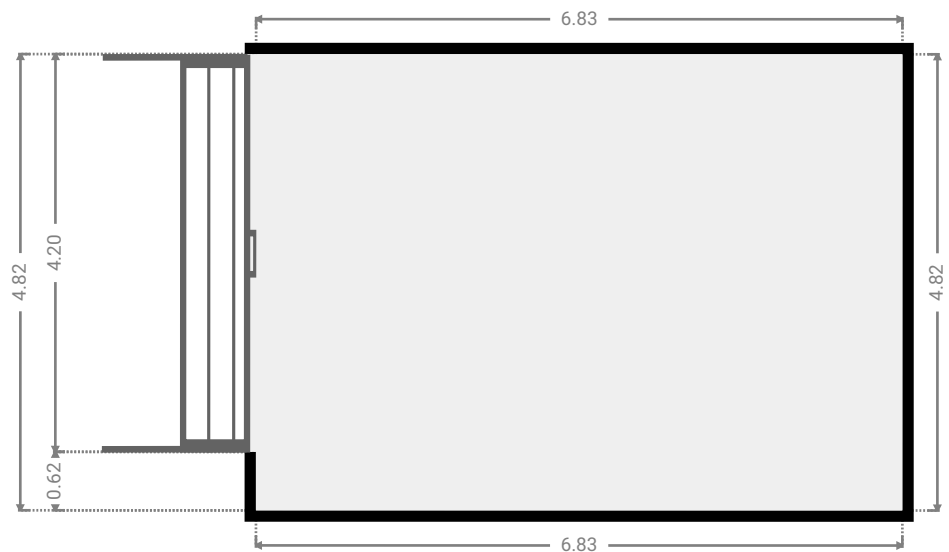
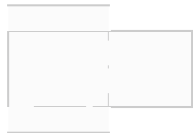

▼ Other
Ground Floor

WIDTH: 12.00 m • LENGTH: 3.00 m
AREA: 36.00 m² • PERIMETER: 30.00 m

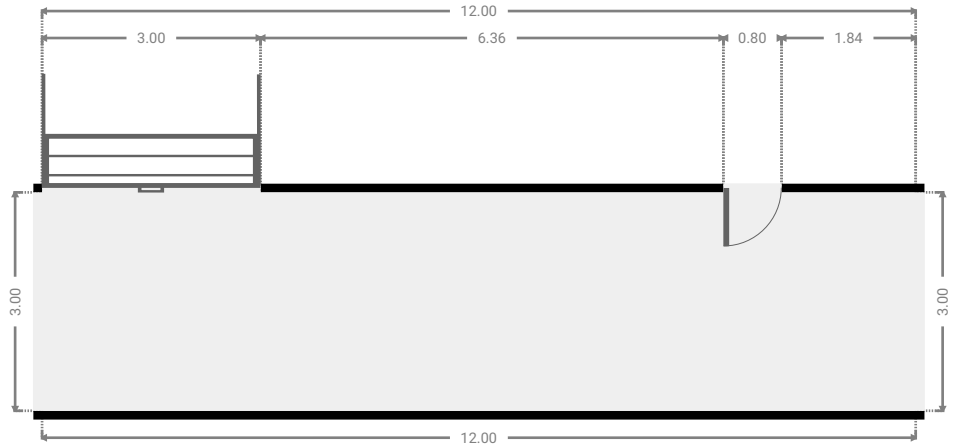
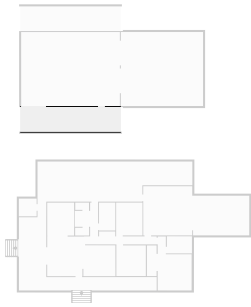

▼ Other
Ground Floor

WIDTH: 12.00 m • LENGTH: 3.00 m
AREA: 36.00 m² • PERIMETER: 30.00 m

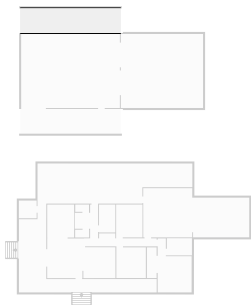

▼ **Other**
Ground Floor

WIDTH: 10.00 m • LENGTH: 9.00 m
AREA: 90.00 m² • PERIMETER: 38.00 m

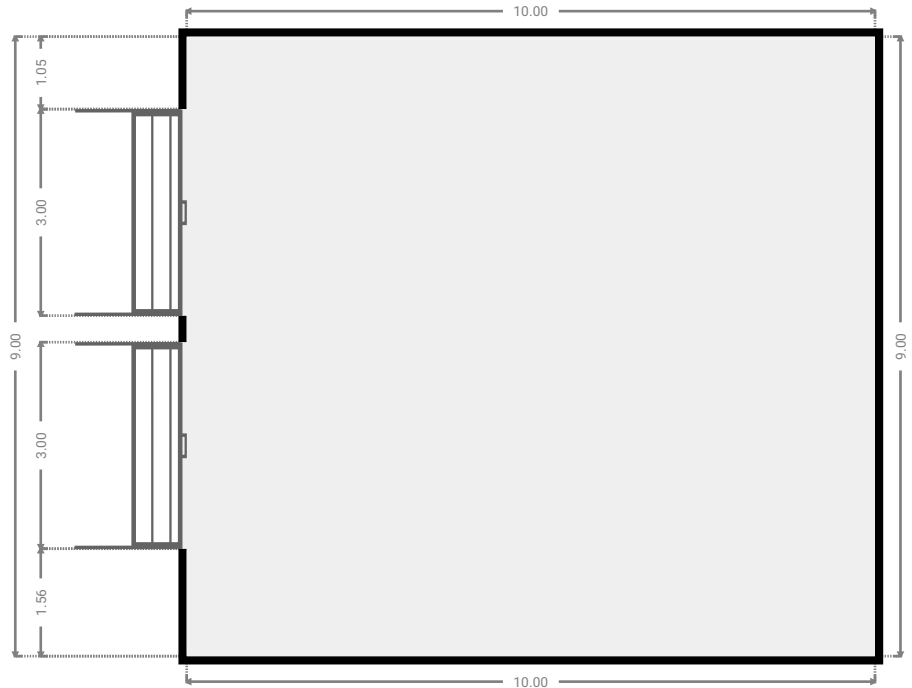
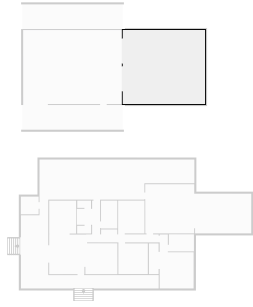

▼ **Other**
Ground Floor

WIDTH: 12.01 m • LENGTH: 9.00 m
AREA: 108.02 m² • PERIMETER: 42.01 m

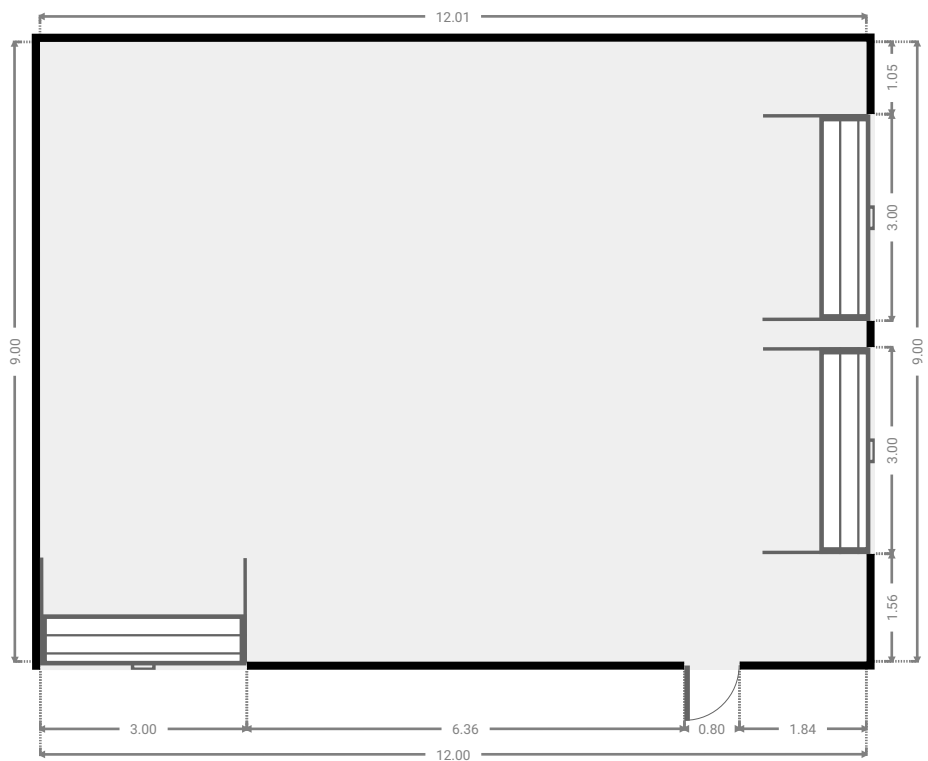
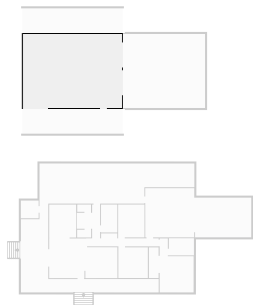

▼ Other Ground Floor

WIDTH: 2.16 m • LENGTH: 2.15 m
AREA: 4.64 m² • PERIMETER: 8.62 m

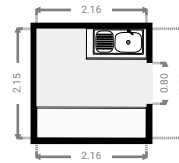
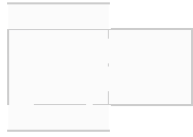

▼ Other Ground Floor

WIDTH: 16.75 m • LENGTH: 8.90 m
AREA: 51.32 m² • PERIMETER: 51.30 m

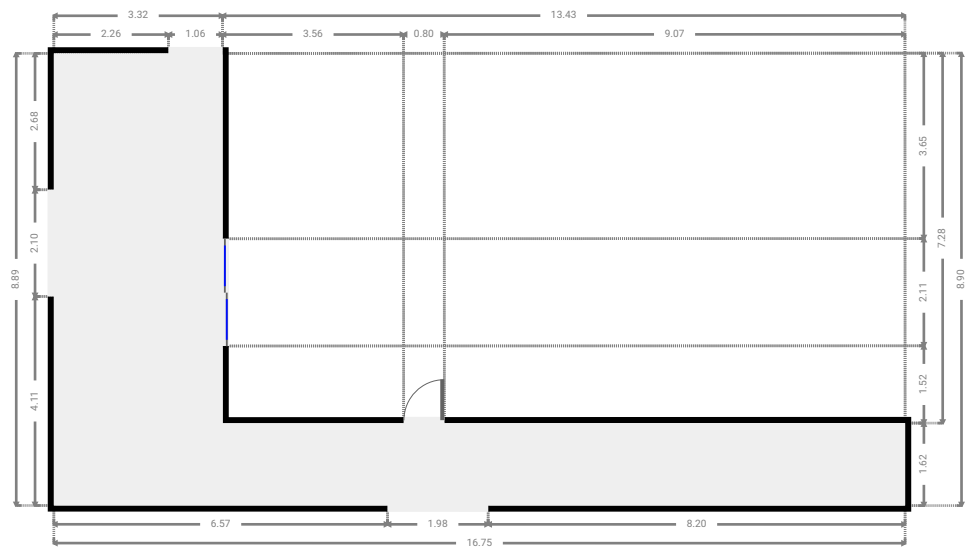

▼ Other Ground Floor

WIDTH: 18.83 m • LENGTH: 6.66 m
AREA: 81.55 m² • PERIMETER: 50.97 m

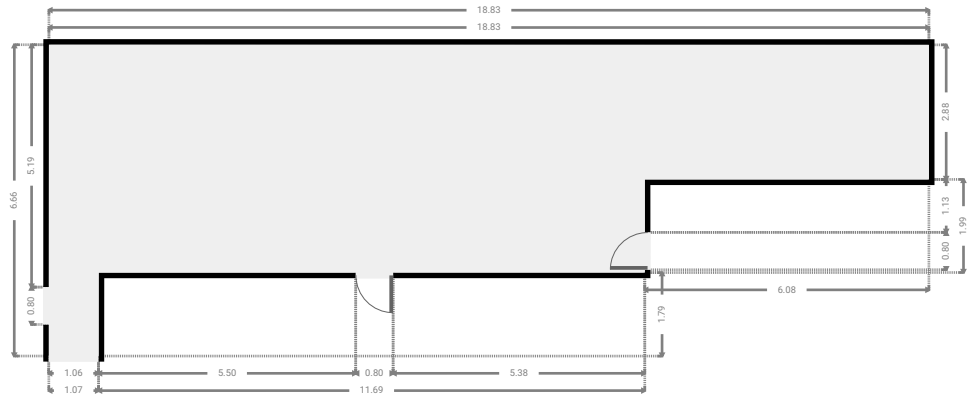

▼ Garage Ground Floor

WIDTH: 5.96 m • LENGTH: 5.98 m
AREA: 35.58 m² • PERIMETER: 23.86 m

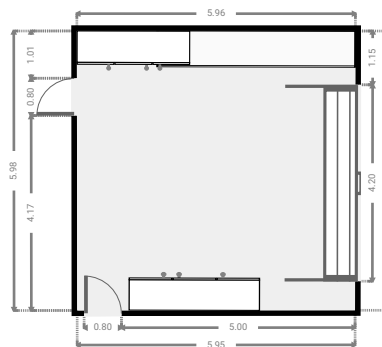

▼ Closet
Ground Floor

WIDTH: 1.18 m • LENGTH: 3.73 m
AREA: 4.40 m² • PERIMETER: 9.82 m

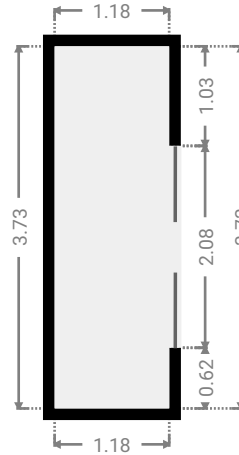
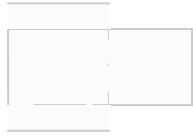

▼ Living Room
Ground Floor

WIDTH: 8.30 m • LENGTH: 4.82 m
AREA: 35.79 m² • PERIMETER: 27.99 m

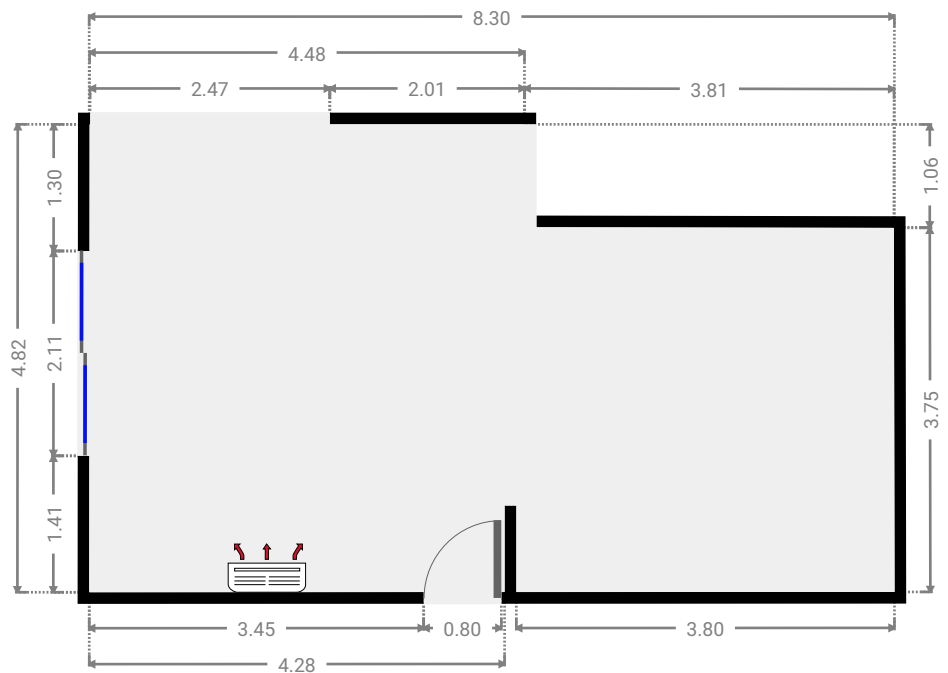
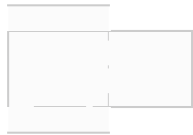

▼ **Master Bedroom**
Ground Floor

WIDTH: 4.13 m • LENGTH: 6.57 m
AREA: 20.28 m² • PERIMETER: 21.37 m

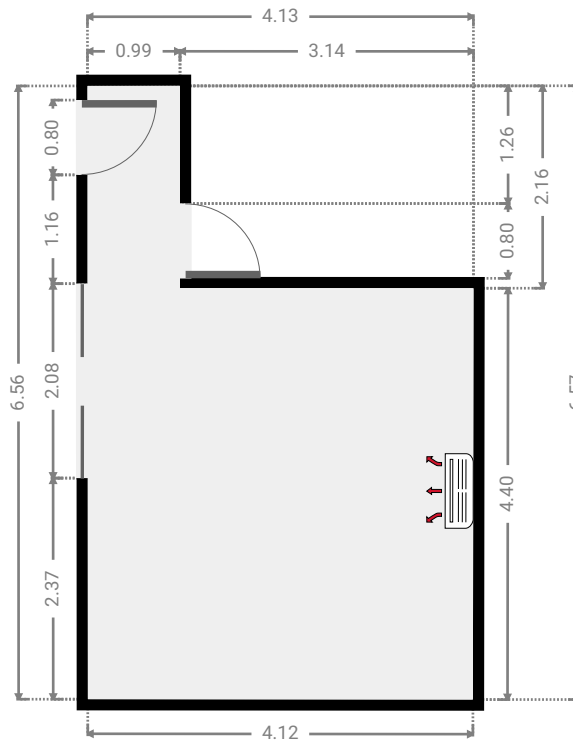

▼ **Bedroom**
Ground Floor

WIDTH: 3.58 m • LENGTH: 3.73 m
AREA: 13.35 m² • PERIMETER: 14.62 m

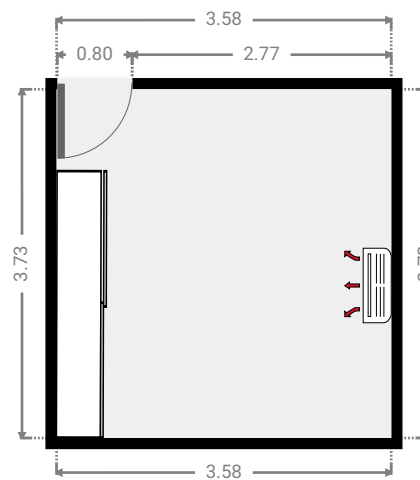

▼ **Bedroom**
Ground Floor

WIDTH: 3.20 m • LENGTH: 3.99 m
AREA: 12.77 m² • PERIMETER: 14.38 m

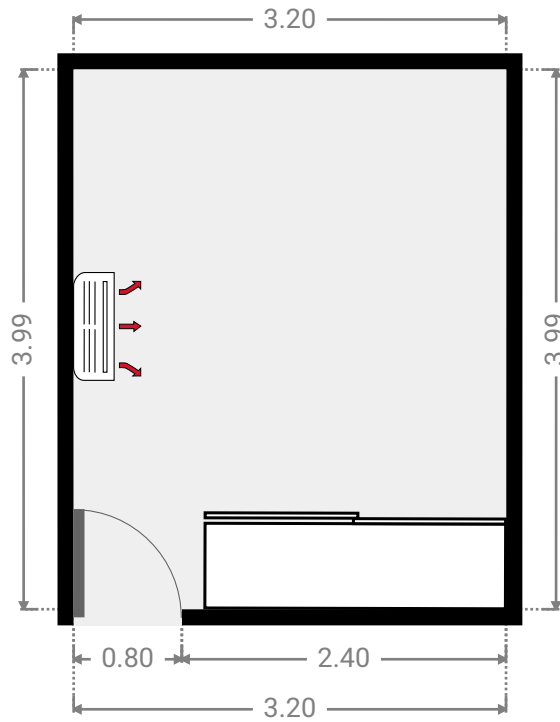

▼ **Bathroom**
Ground Floor

WIDTH: 1.98 m • LENGTH: 3.39 m
AREA: 6.71 m² • PERIMETER: 10.74 m

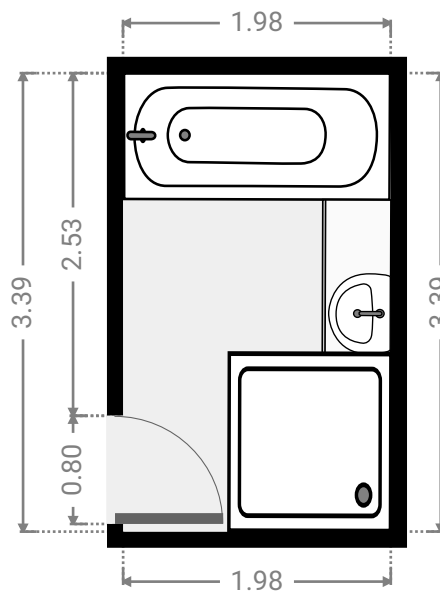
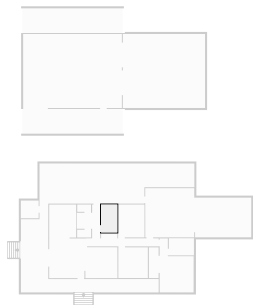

▼ **Hall**
Ground Floor

WIDTH: 0.97 m • LENGTH: 3.99 m
AREA: 3.87 m² • PERIMETER: 9.92 m

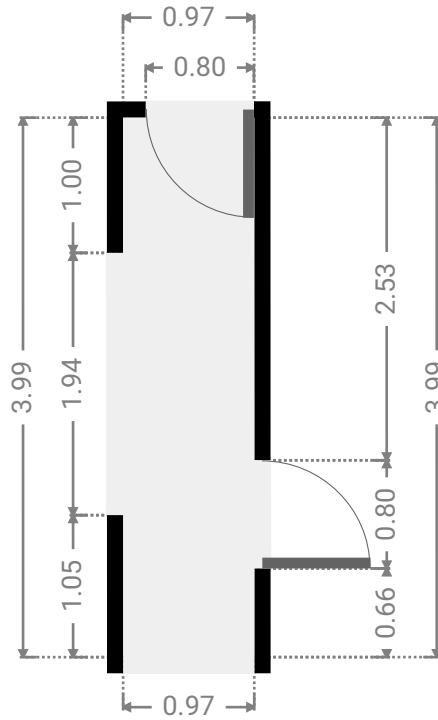

▼ **Toilet**
Ground Floor

WIDTH: 1.67 m • LENGTH: 0.88 m
AREA: 1.47 m² • PERIMETER: 5.10 m

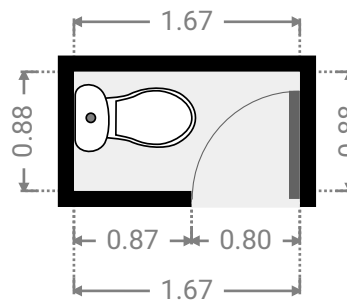
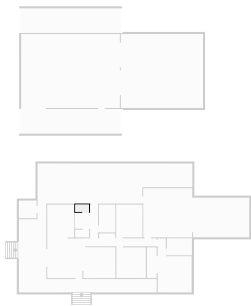

▼ **Laundry Room**
Ground Floor

WIDTH: 1.78 m • LENGTH: 1.94 m
AREA: 3.45 m² • PERIMETER: 7.44 m

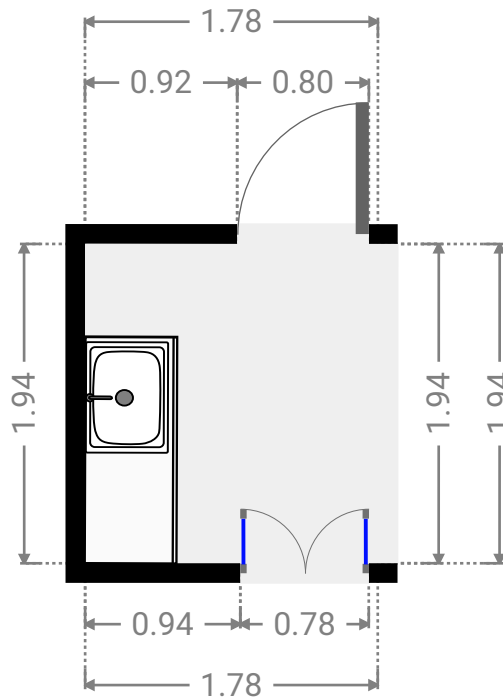
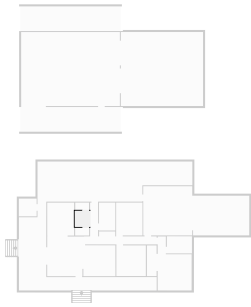

▼ **Music Room**
Ground Floor

WIDTH: 1.70 m • LENGTH: 0.94 m
AREA: 1.60 m² • PERIMETER: 5.28 m

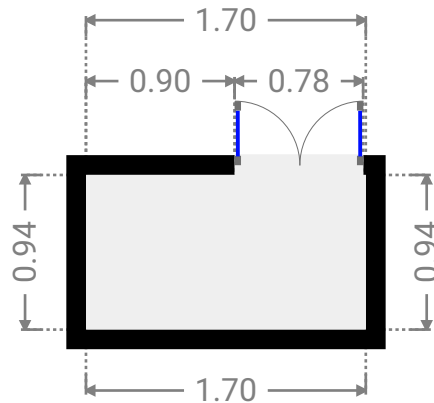
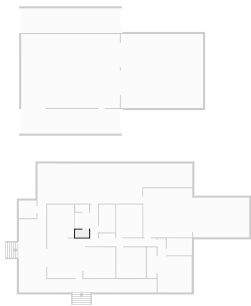

▼ **Hall**
Ground Floor

WIDTH: 8.71 m • LENGTH: 1.57 m
AREA: 9.64 m² • PERIMETER: 20.56 m

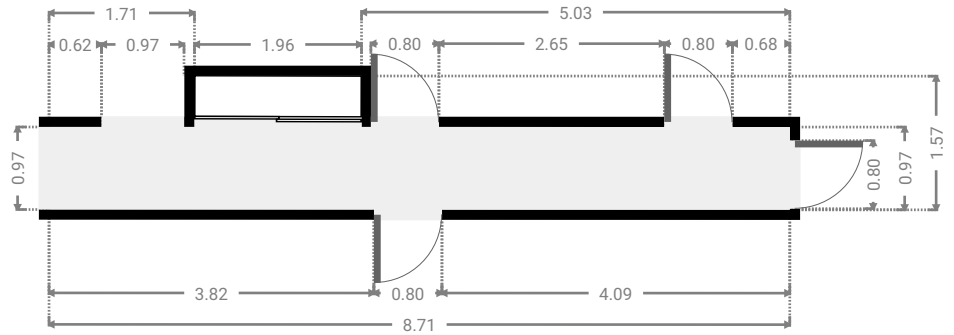

▼ **Kitchen**
Ground Floor

WIDTH: 3.27 m • LENGTH: 4.00 m
AREA: 13.08 m² • PERIMETER: 14.54 m

