

15 Madge Street

Ground Floor

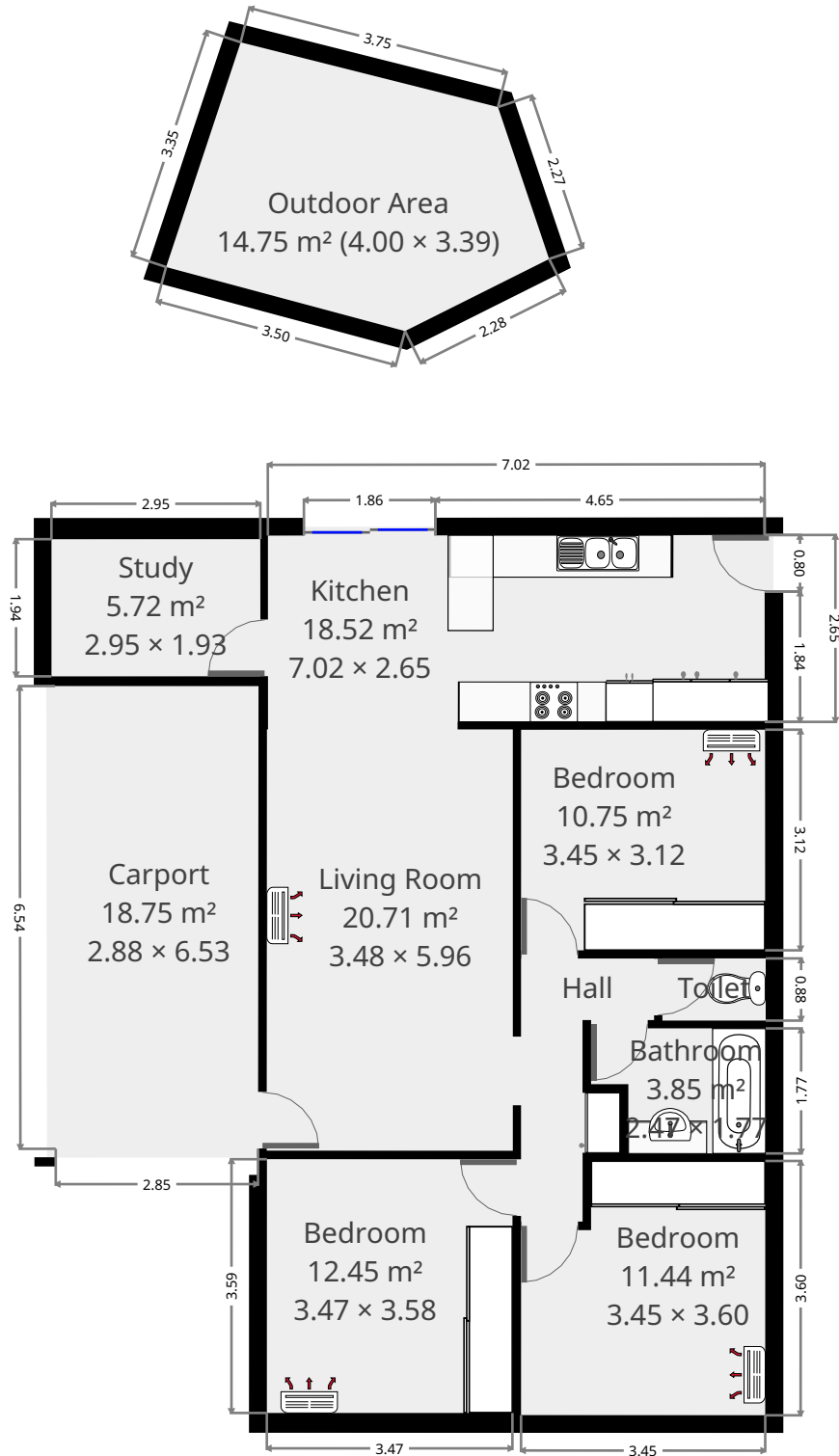

THIS FLOORPLAN IS PROVIDED WITHOUT WARRANTY OF ANY KIND. SENSOPIA DISCLAIMS ANY WARRANTY INCLUDING, WITHOUT LIMITATION, SATISFACTORY QUALITY OR ACCURACY OF DIMENSIONS.



15 Madge Street

Bedroom

Width: 3.12 m
Length: 3.45 m
Area: 10.75 m²
Perimeter: 13.13 m

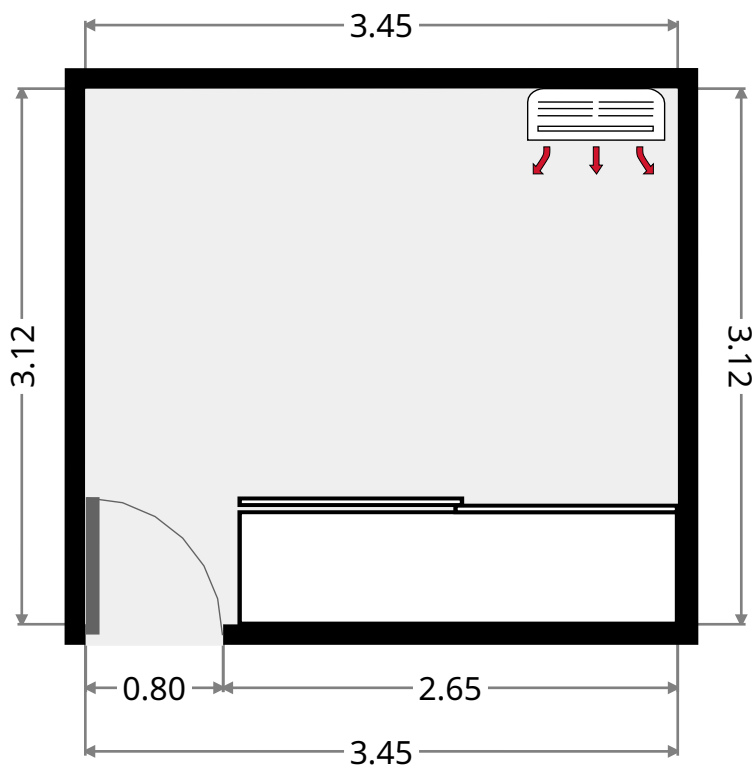
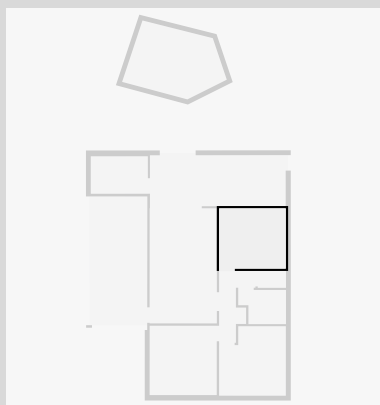

Toilet / Half Bath

Width: 0.88 m
Length: 1.46 m
Area: 1.28 m²
Perimeter: 4.68 m

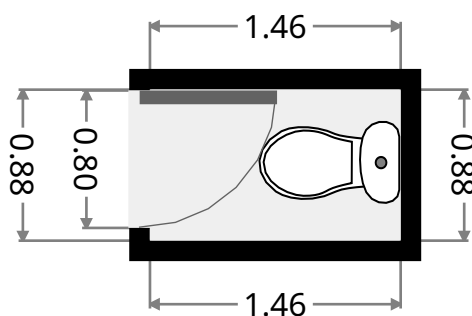
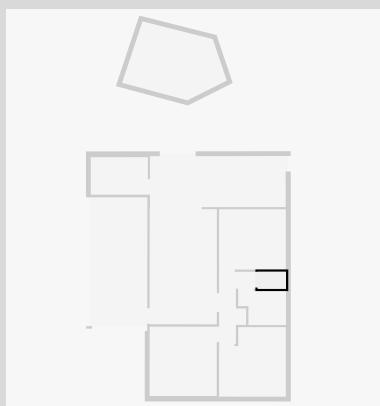

15 Madge Street

Bathroom

Width: 1.77 m
 Length: 2.47 m
 Area: 3.85 m²
 Perimeter: 8.47 m

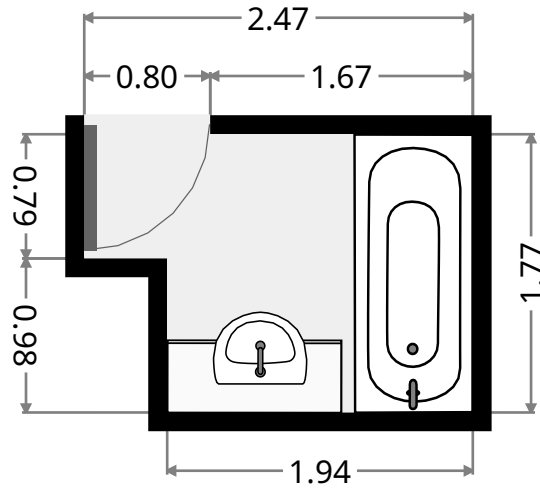
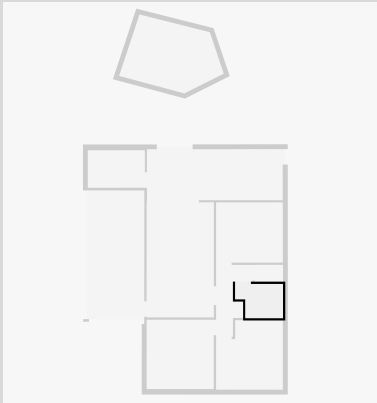

Bedroom

Width: 3.45 m
 Length: 3.60 m
 Area: 11.44 m²
 Perimeter: 14.09 m

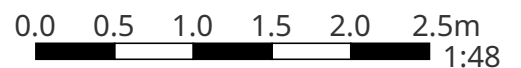
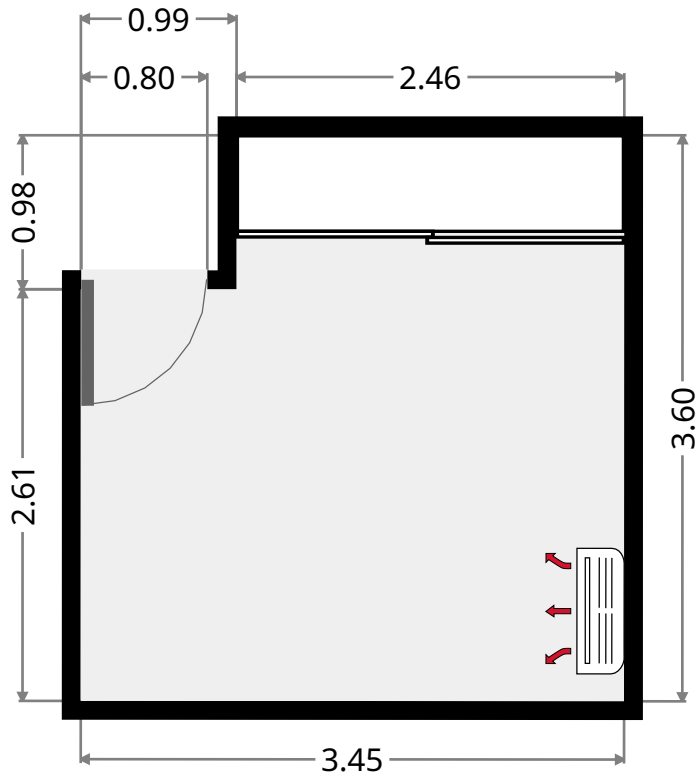
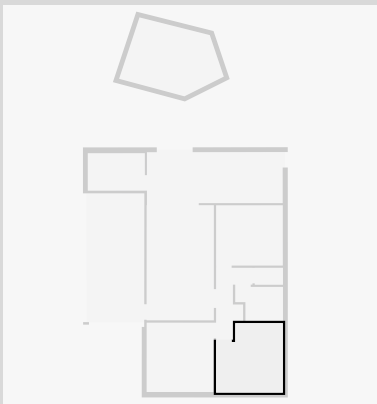

THIS FLOORPLAN IS PROVIDED WITHOUT WARRANTY OF ANY KIND. SENSOPIA DISCLAIMS ANY WARRANTY INCLUDING, WITHOUT LIMITATION, SATISFACTORY QUALITY OR ACCURACY OF DIMENSIONS.

15 Madge Street

Bedroom

Width: 3.47 m
 Length: 3.58 m
 Area: 12.45 m²
 Perimeter: 14.11 m

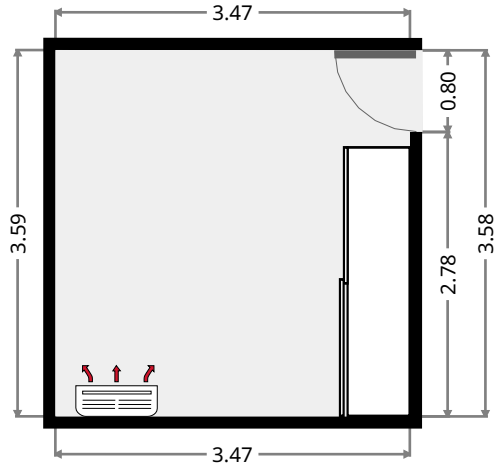
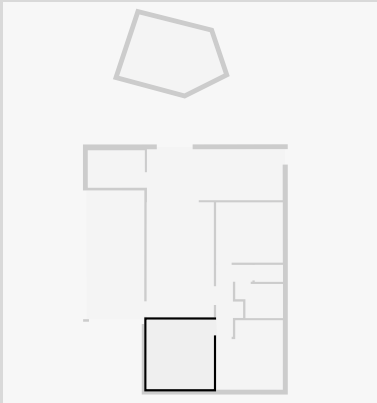

Kitchen

Width: 2.65 m
 Length: 7.02 m
 Area: 18.52 m²
 Perimeter: 19.32 m

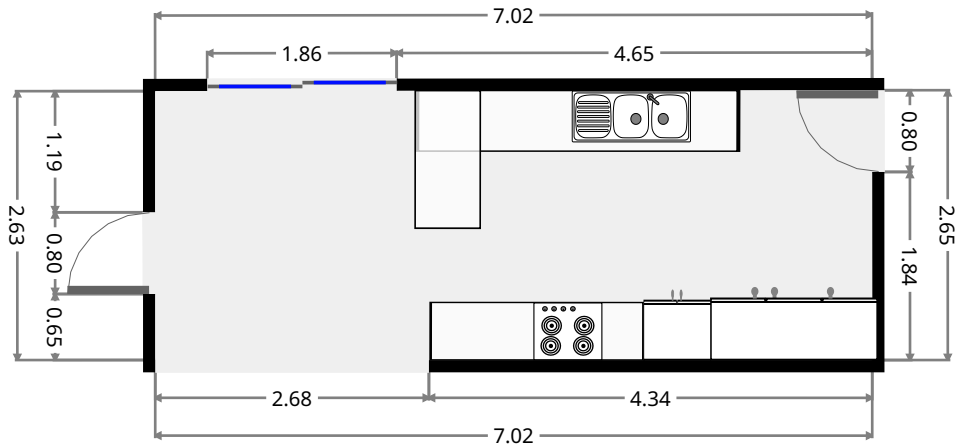
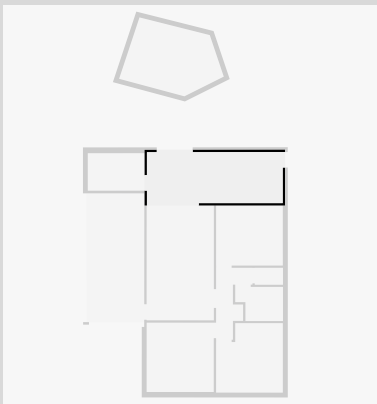

THIS FLOORPLAN IS PROVIDED WITHOUT WARRANTY OF ANY KIND. SENSOPIA DISCLAIMS ANY WARRANTY INCLUDING, WITHOUT LIMITATION, SATISFACTORY QUALITY OR ACCURACY OF DIMENSIONS.



15 Madge Street

Study

Width: 1.93 m
Length: 2.95 m
Area: 5.72 m²
Perimeter: 9.78 m

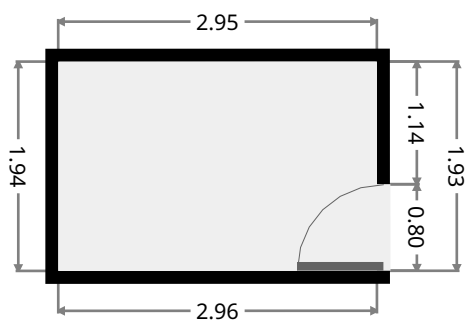
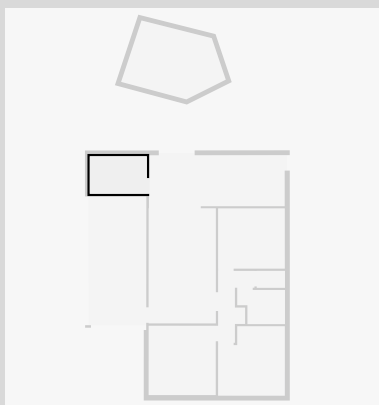

Carport

Width: 2.88 m
Length: 6.53 m
Area: 18.75 m²
Perimeter: 18.81 m

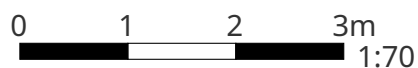
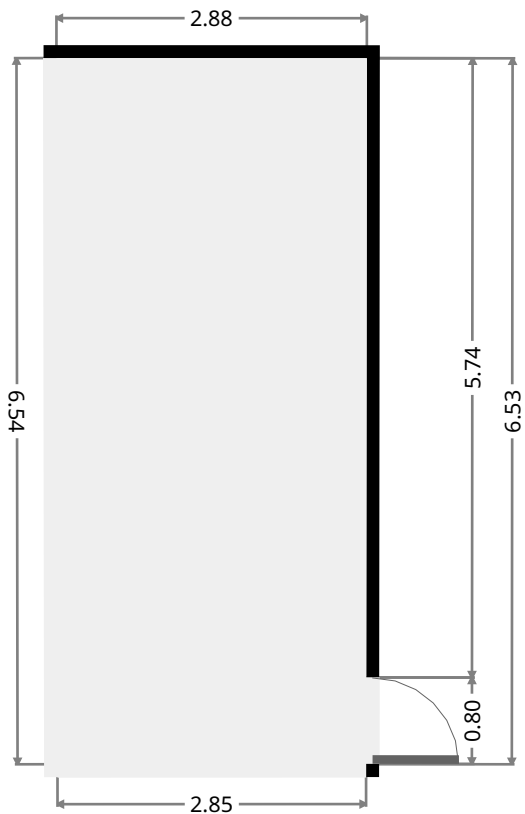
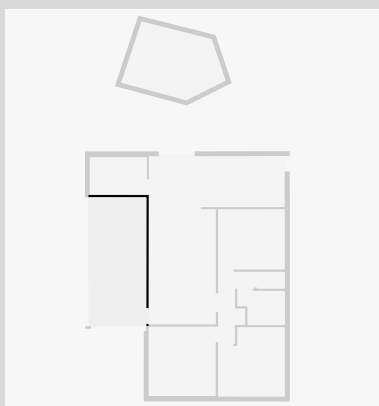

THIS FLOORPLAN IS PROVIDED WITHOUT WARRANTY OF ANY KIND. SENSOPIA DISCLAIMS ANY WARRANTY INCLUDING, WITHOUT LIMITATION, SATISFACTORY QUALITY OR ACCURACY OF DIMENSIONS.

15 Madge Street

Outdoor Area

Width: 3.39 m
Length: 4.00 m
Area: 14.75 m²
Perimeter: 15.14 m

