

# 15 Gowdie Avenue

**SUBMITTED BY**

Ray White Rockhampton Casey  
stockers@cqoz.com

---

**CREATED ON**

2021-12-08

---

**Floors**

2

---

▼ Ground Floor

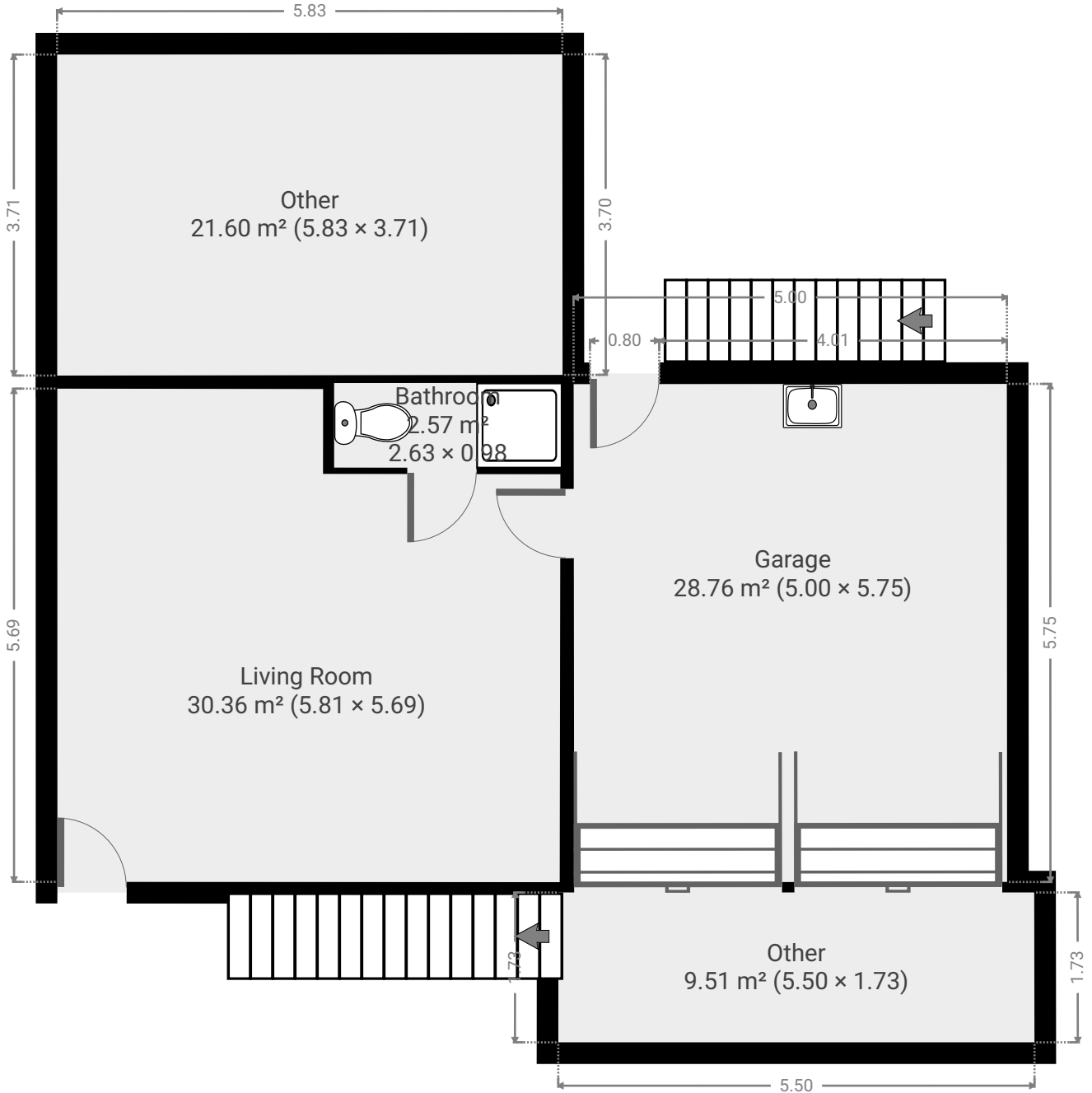

▼ Garage  
Ground Floor

WIDTH: 5.00 m • LENGTH: 5.75 m  
AREA: 28.76 m<sup>2</sup> • PERIMETER: 21.50 m

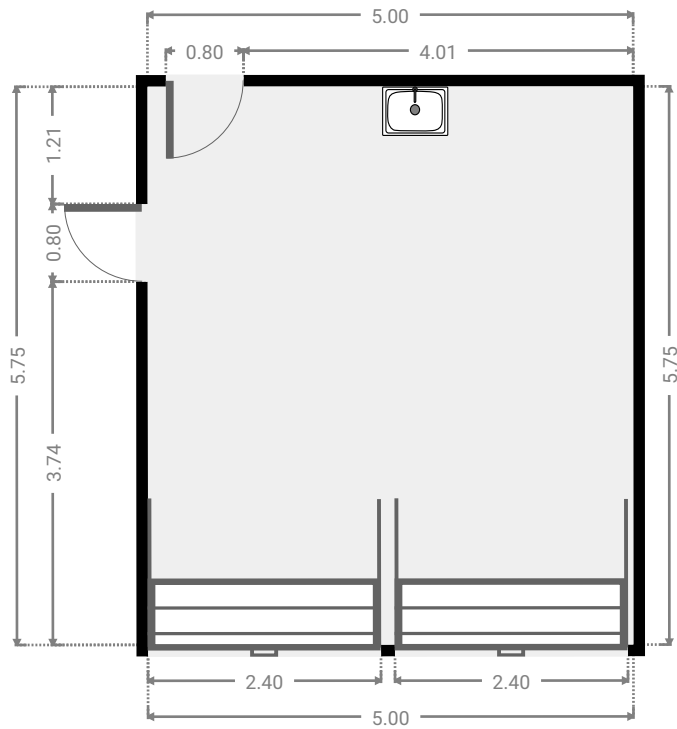
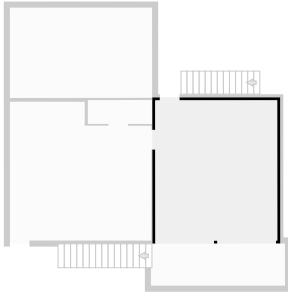

▼ Living Room  
Ground Floor

WIDTH: 5.81 m • LENGTH: 5.61 m  
AREA: 30.36 m<sup>2</sup> • PERIMETER: 22.99 m

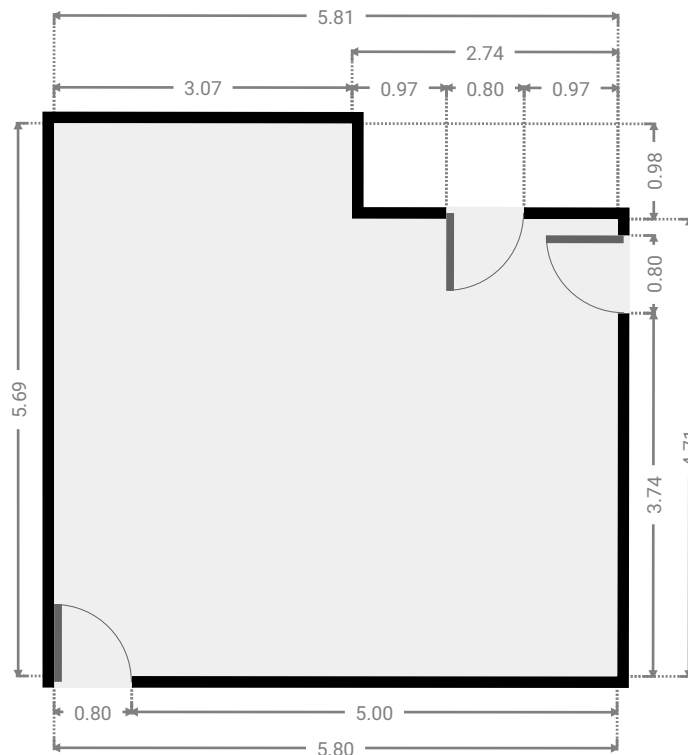
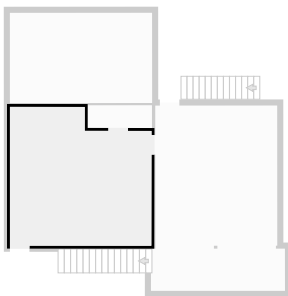

▼ Bathroom  
Ground Floor

WIDTH: 2.63 m • LENGTH: 0.98 m  
AREA: 2.57 m<sup>2</sup> • PERIMETER: 7.22 m

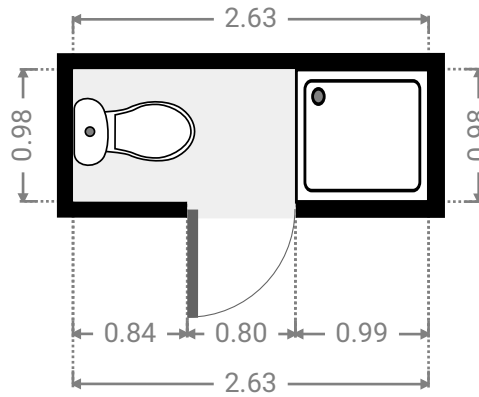
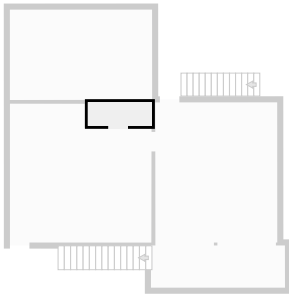

▼ Other  
Ground Floor

WIDTH: 5.81 m • LENGTH: 3.71 m  
AREA: 21.60 m<sup>2</sup> • PERIMETER: 19.07 m

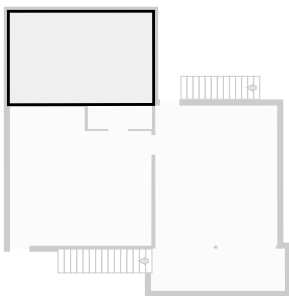

▼ Other  
Ground Floor

WIDTH: 5.50 m • LENGTH: 1.73 m  
AREA: 9.51 m<sup>2</sup> • PERIMETER: 14.45 m

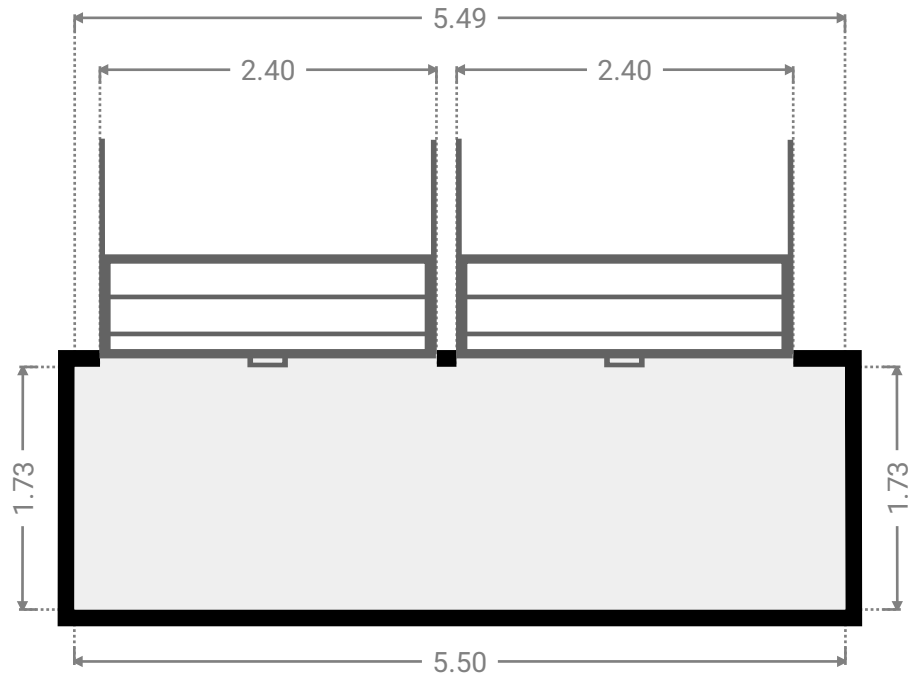
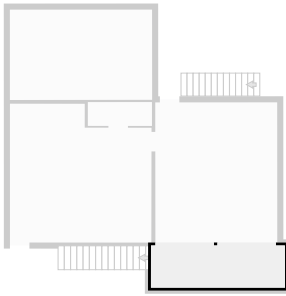

▼ 1st Floor

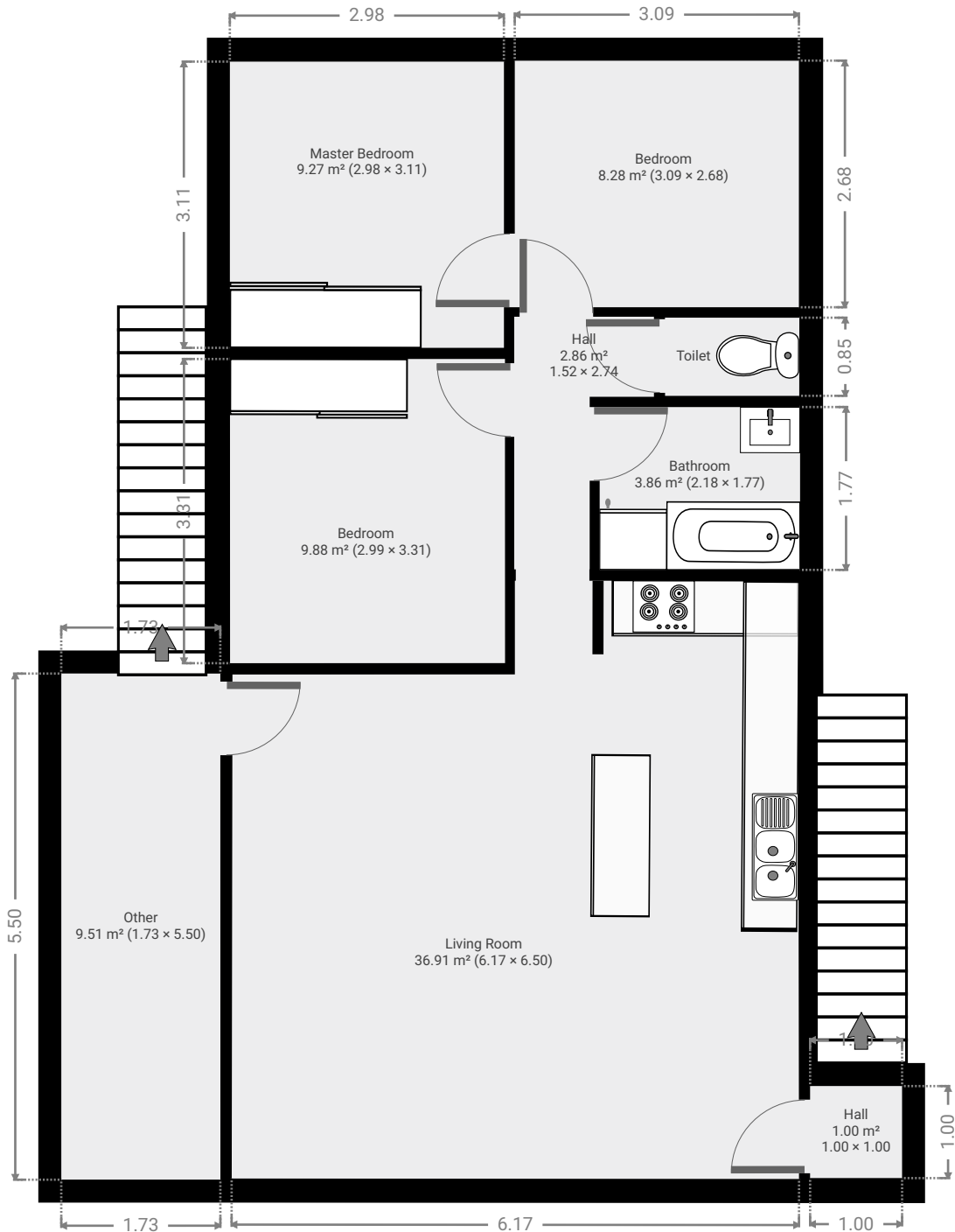

▼ **Living Room**  
1st Floor

WIDTH: 6.50 m • LENGTH: 6.17 m  
AREA: 36.91 m<sup>2</sup> • PERIMETER: 25.32 m

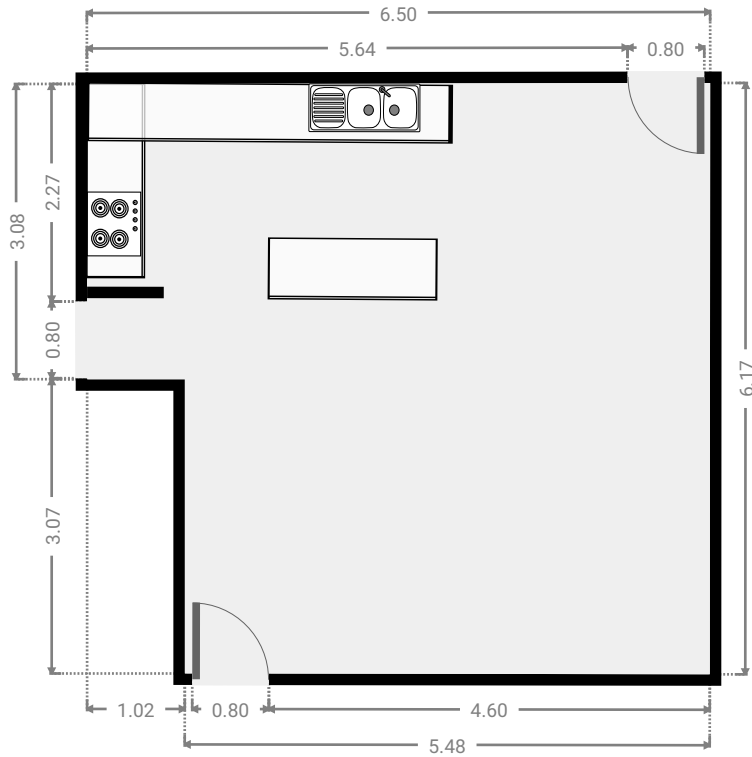
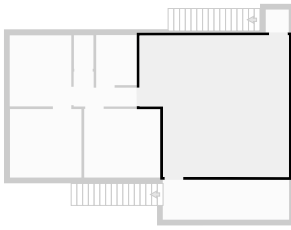

▼ **Hall**  
1st Floor

WIDTH: 2.74 m • LENGTH: 1.52 m  
AREA: 2.86 m<sup>2</sup> • PERIMETER: 8.53 m

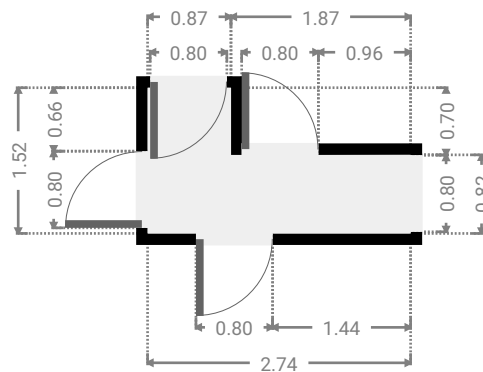
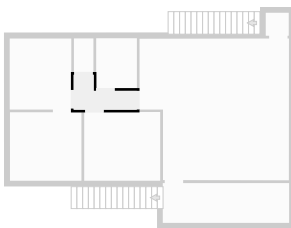

▼ **Bedroom**  
1st Floor

WIDTH: 3.31 m • LENGTH: 2.99 m  
AREA: 9.88 m<sup>2</sup> • PERIMETER: 12.59 m

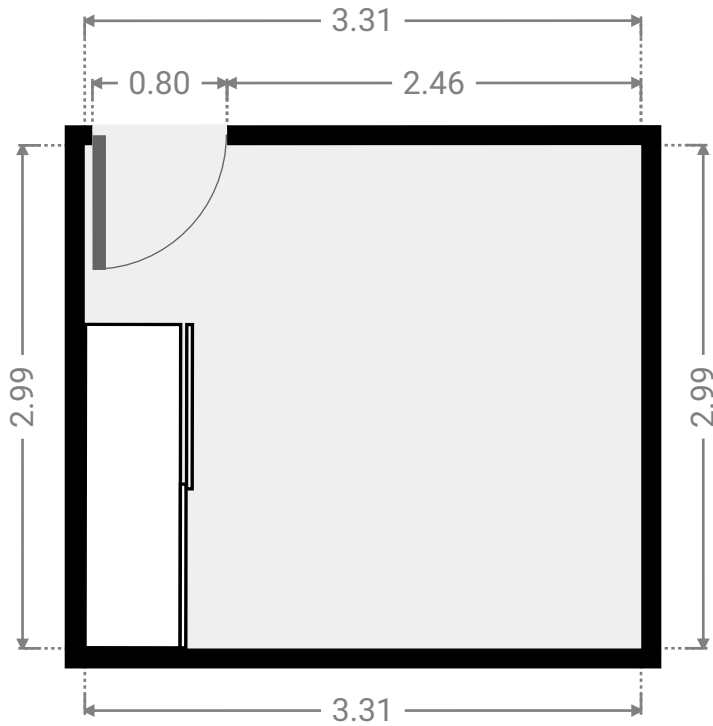
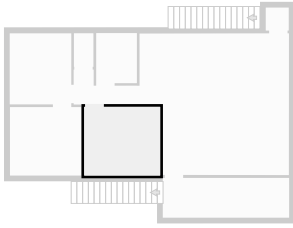

▼ **Master Bedroom**  
1st Floor

WIDTH: 3.11 m • LENGTH: 2.98 m  
AREA: 9.27 m<sup>2</sup> • PERIMETER: 12.18 m

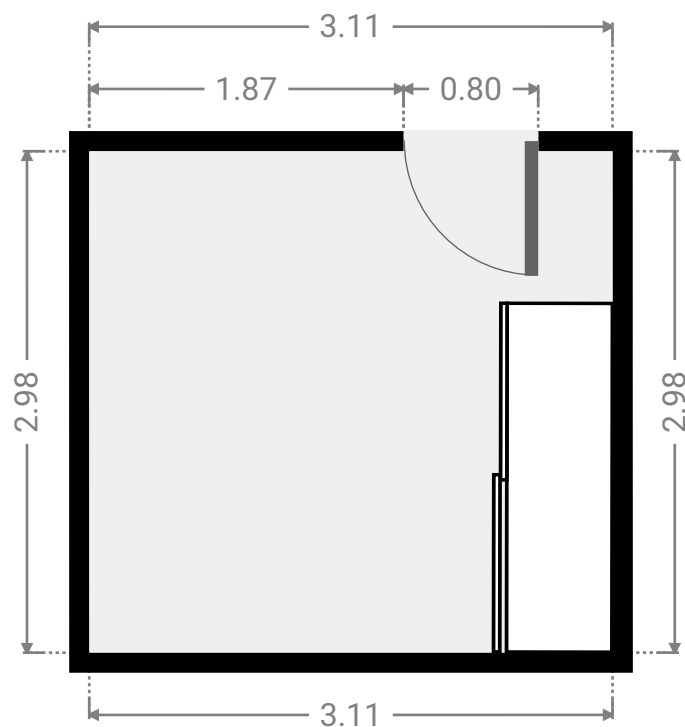
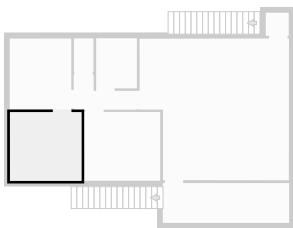



▼ **Bedroom**  
1st Floor

WIDTH: 2.68 m • LENGTH: 3.09 m  
AREA: 8.28 m<sup>2</sup> • PERIMETER: 11.54 m

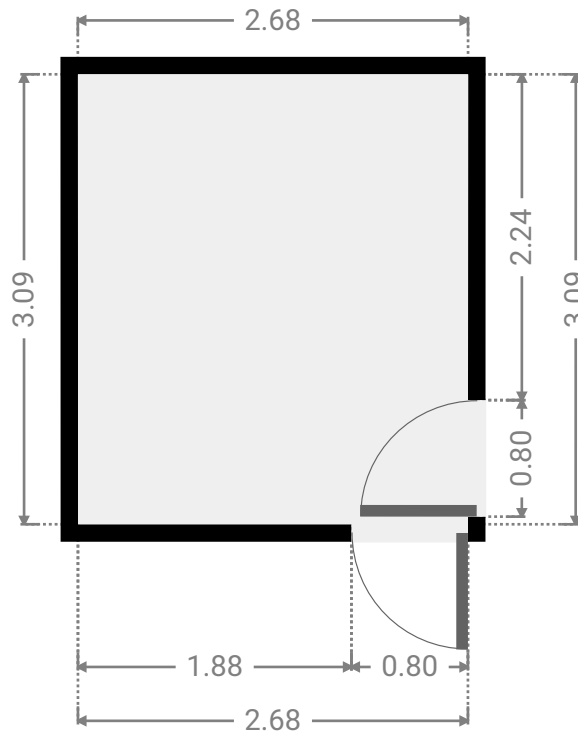
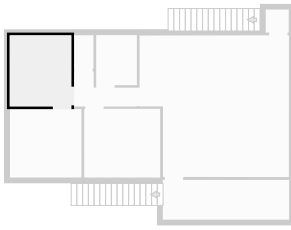

▼ **Toilet**  
1st Floor

WIDTH: 0.85 m • LENGTH: 1.46 m  
AREA: 1.24 m<sup>2</sup> • PERIMETER: 4.62 m

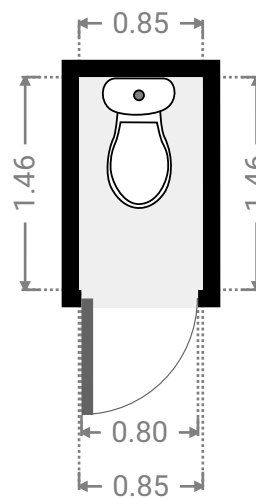
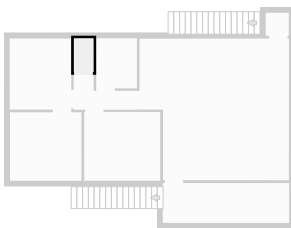

▼ **Bathroom**  
1st Floor

WIDTH: 1.77 m • LENGTH: 2.18 m  
AREA: 3.86 m<sup>2</sup> • PERIMETER: 7.90 m

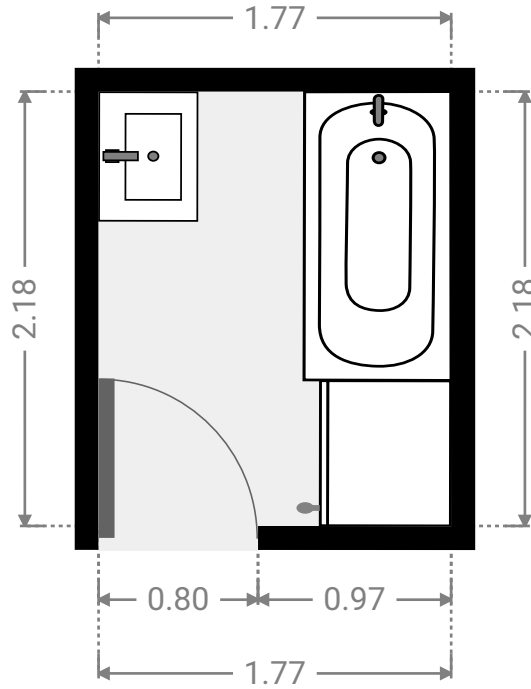
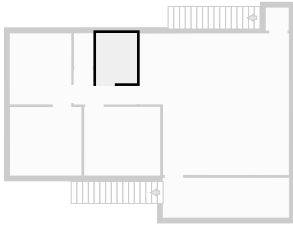

▼ **Hall**  
1st Floor

WIDTH: 1.00 m • LENGTH: 1.00 m  
AREA: 1.00 m<sup>2</sup> • PERIMETER: 4.00 m

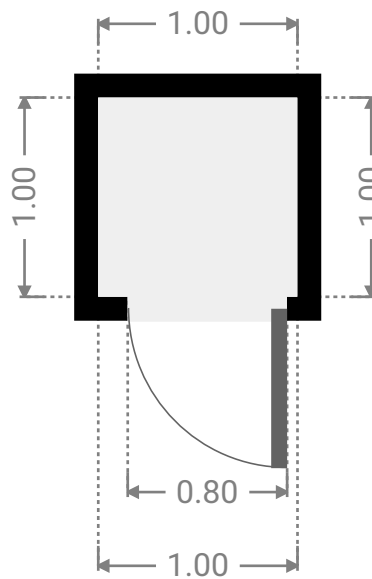
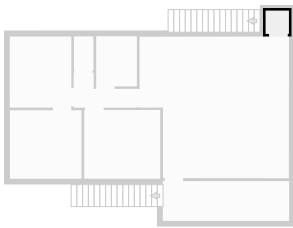

▼ Other  
1st Floor

WIDTH: 5.50 m • LENGTH: 1.73 m  
AREA: 9.51 m<sup>2</sup> • PERIMETER: 14.46 m

