

15 Frangipani Court

SUBMITTED BY

Ray White Rockhampton Casey
stockers@cqoz.com

CREATED ON

2022-06-27

Floors

1

▼ Ground Floor



FLOORS: 1

▼ Bathroom
Ground Floor

WIDTH: 4.28 m • LENGTH: 2.30 m
AREA: 7.87 m² • PERIMETER: 15.82 m

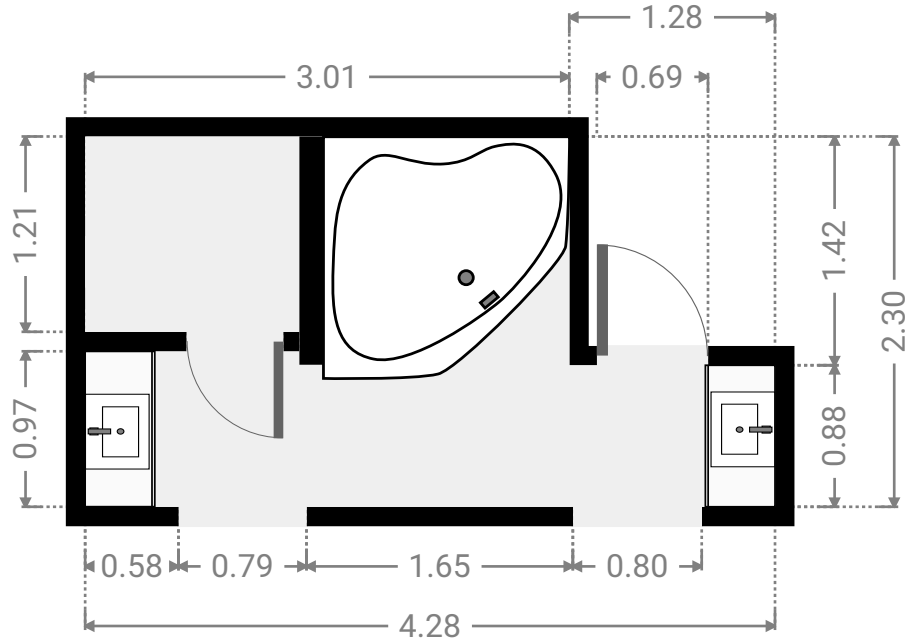
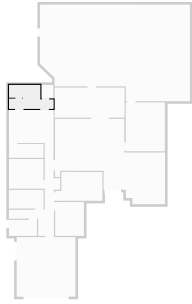

▼ Bathroom
Ground Floor

WIDTH: 3.35 m • LENGTH: 1.80 m
AREA: 6.03 m² • PERIMETER: 10.30 m

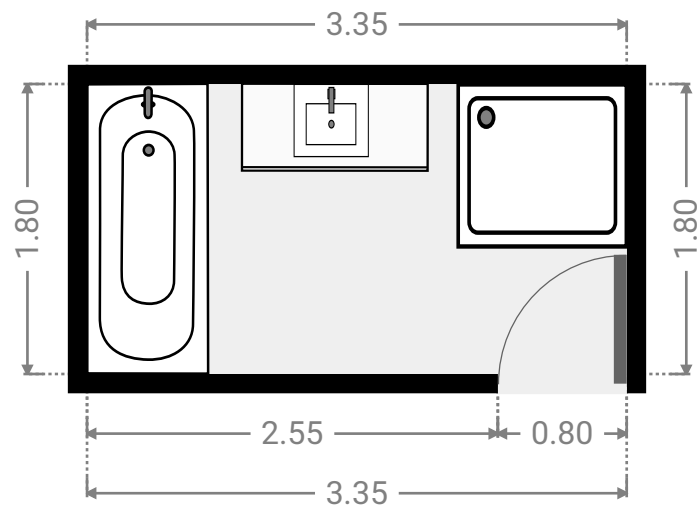
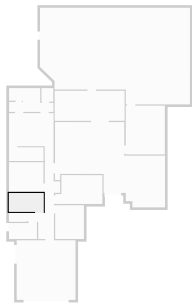

FLOORS: 1

▼ Bedroom Ground Floor

WIDTH: 3.33 m • LENGTH: 2.87 m
AREA: 9.56 m² • PERIMETER: 12.40 m

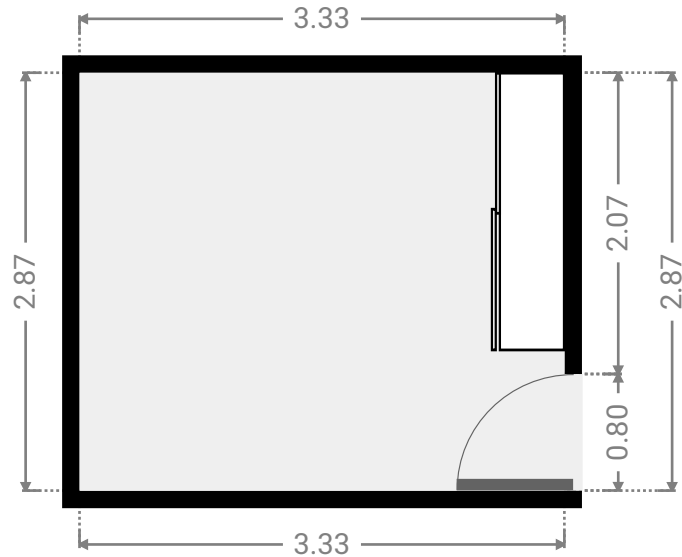
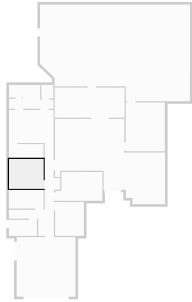

▼ Bedroom Ground Floor

WIDTH: 4.56 m • LENGTH: 2.80 m
AREA: 11.62 m² • PERIMETER: 14.71 m

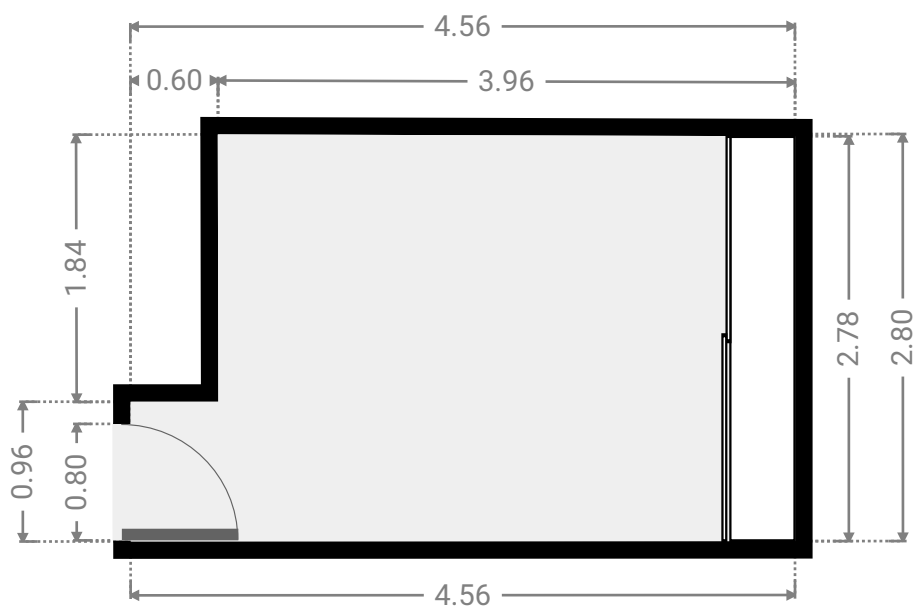
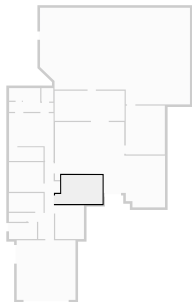

FLOORS: 1

▼ Bedroom Ground Floor

WIDTH: 2.78 m • LENGTH: 3.27 m
AREA: 9.09 m² • PERIMETER: 12.10 m

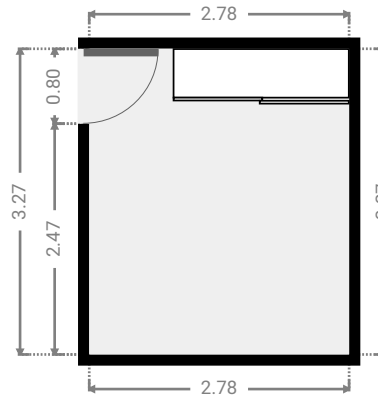
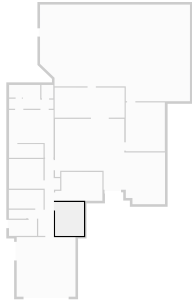

▼ Garage Ground Floor

WIDTH: 5.68 m • LENGTH: 5.76 m
AREA: 32.72 m² • PERIMETER: 22.88 m

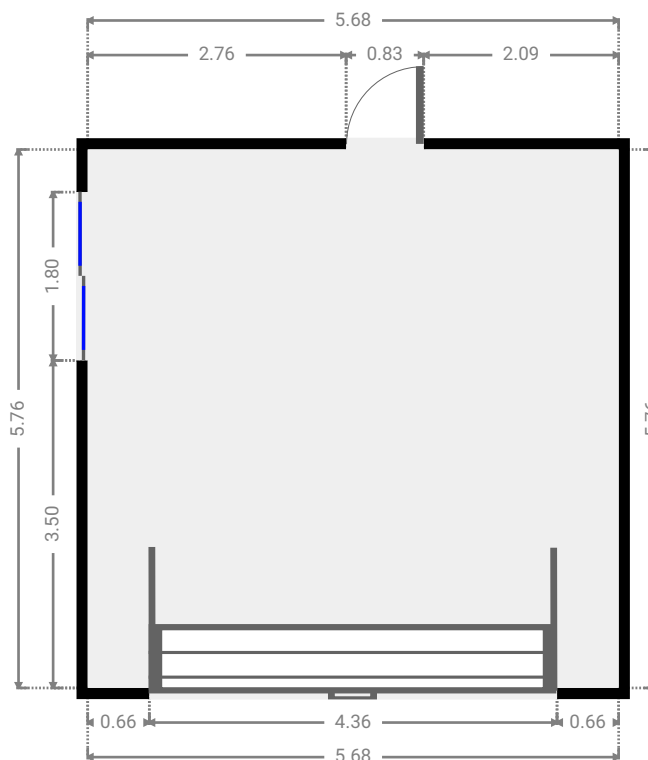
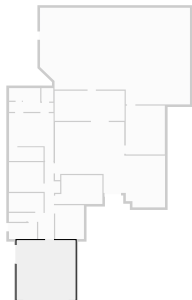

▼ **Hall**
Ground Floor

WIDTH: 3.14 m • LENGTH: 7.44 m
AREA: 9.71 m² • PERIMETER: 21.17 m

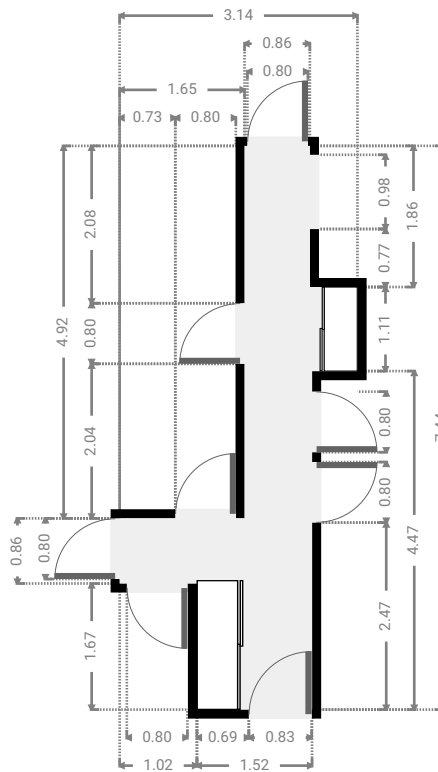
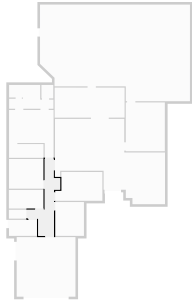

▼ **Laundry Room**
Ground Floor

WIDTH: 2.70 m • LENGTH: 1.55 m
AREA: 4.18 m² • PERIMETER: 8.50 m

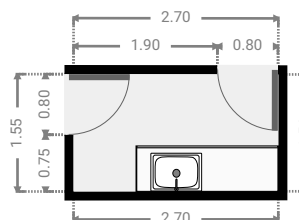
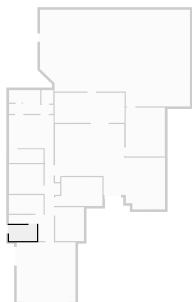

FLOORS: 1

▼ Living Room Ground Floor

WIDTH: 10.64 m • LENGTH: 8.25 m
AREA: 56.66 m² • PERIMETER: 38.98 m

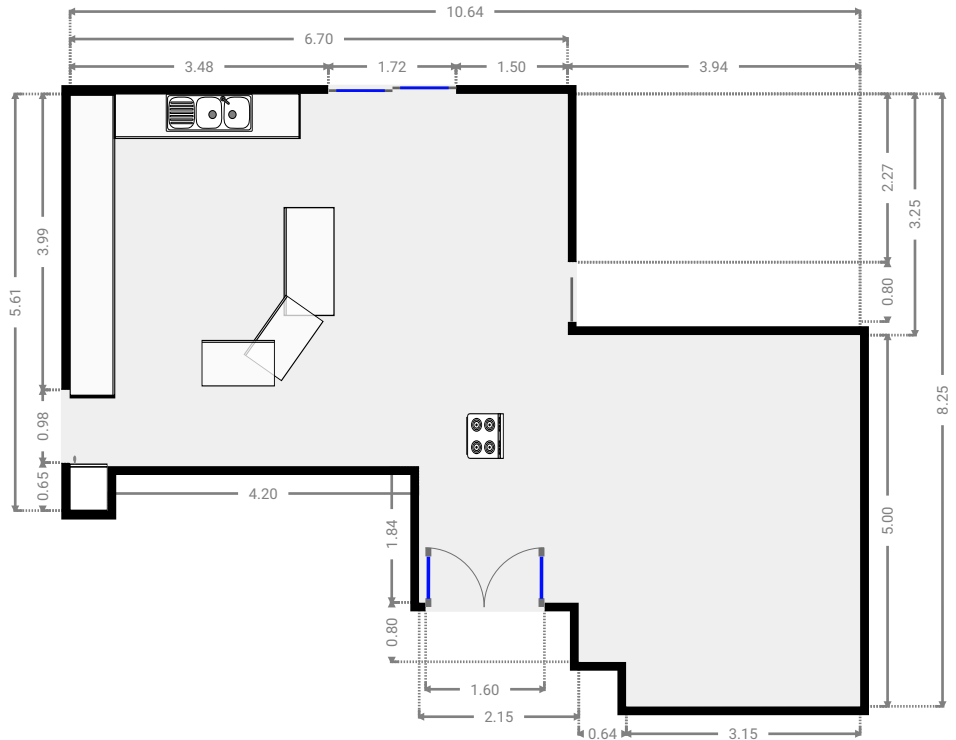
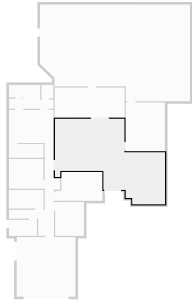

▼ Living Room Ground Floor

WIDTH: 3.78 m • LENGTH: 4.72 m
AREA: 17.84 m² • PERIMETER: 17.00 m

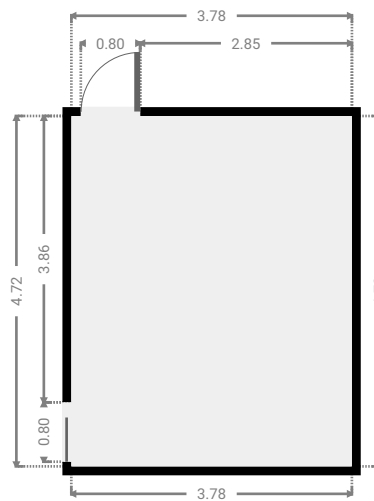
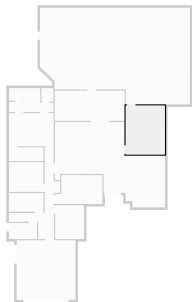

15 Frangipani Court

FLOORS: 1



▼ Other Ground Floor

WIDTH: 6.76 m • LENGTH: 2.91 m
AREA: 19.65 m² • PERIMETER: 19.33 m

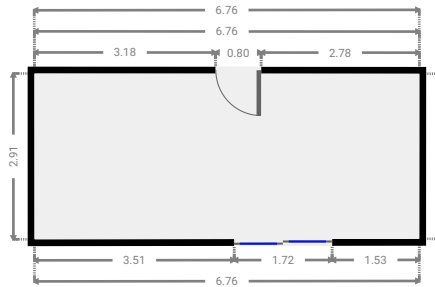
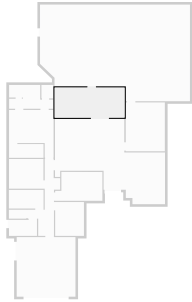

▼ Other Ground Floor

WIDTH: 14.50 m • LENGTH: 9.34 m
AREA: 121.40 m² • PERIMETER: 46.87 m

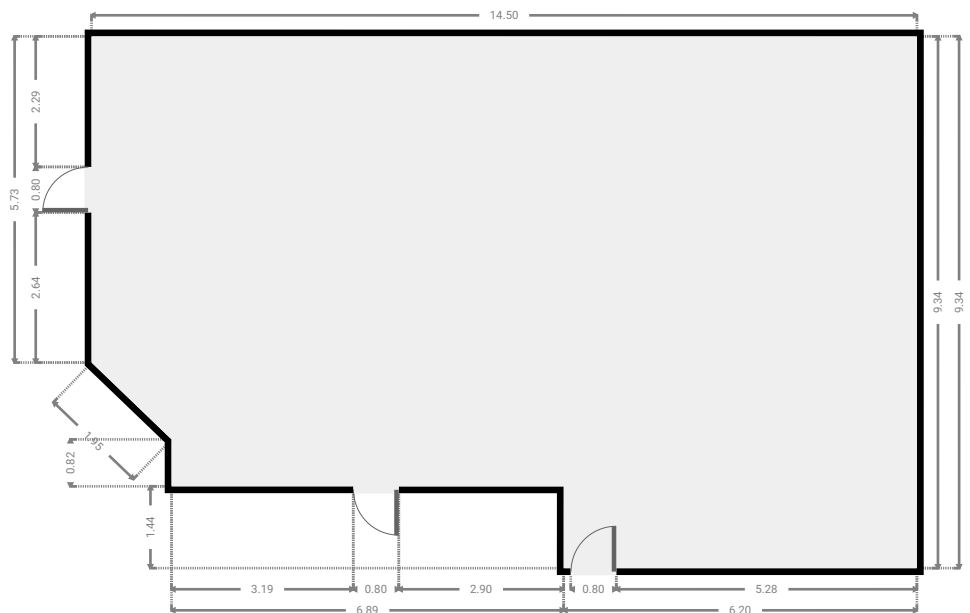
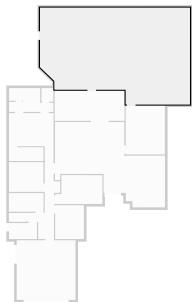

▼ Primary Bedroom Ground Floor

WIDTH: 4.30 m • LENGTH: 4.60 m
AREA: 14.96 m² • PERIMETER: 17.81 m

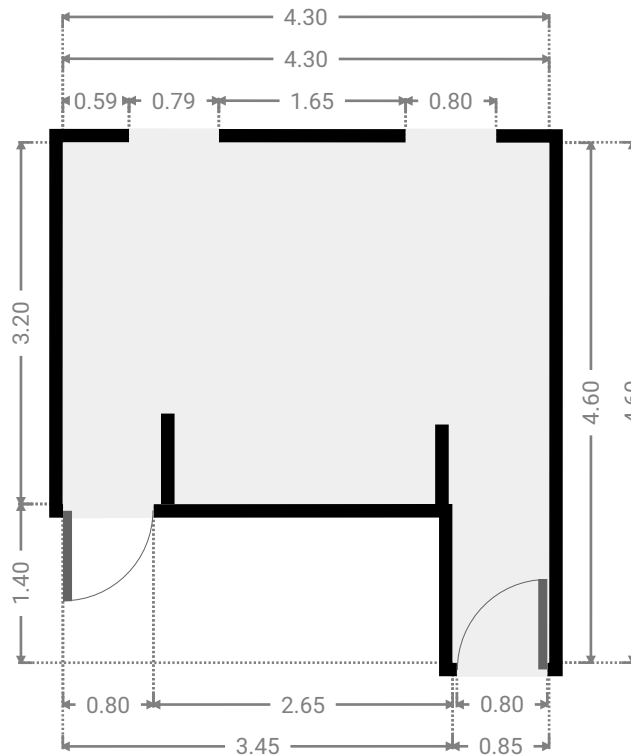
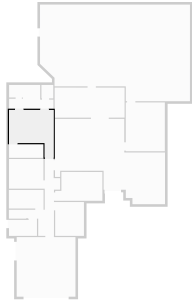

▼ Closet Ground Floor

WIDTH: 3.33 m • LENGTH: 1.33 m
AREA: 4.43 m² • PERIMETER: 9.32 m

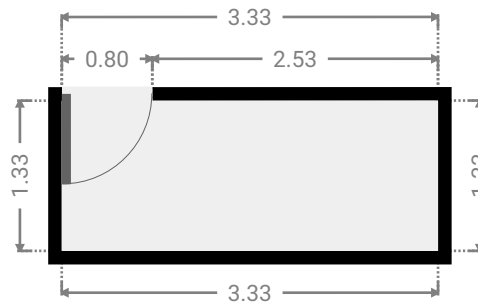
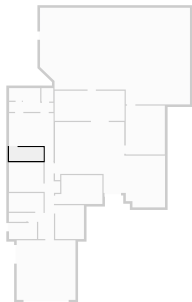

▼ Toilet Ground Floor

WIDTH: 1.14 m • LENGTH: 1.30 m
AREA: 1.49 m² • PERIMETER: 4.89 m

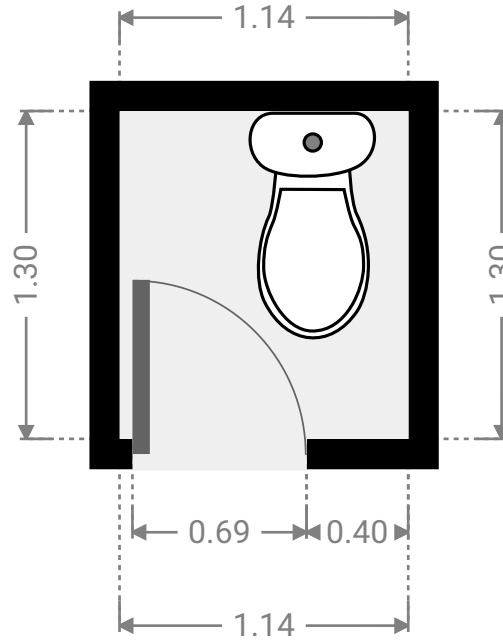
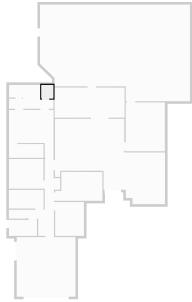

▼ Toilet Ground Floor

WIDTH: 1.70 m • LENGTH: 0.86 m
AREA: 1.46 m² • PERIMETER: 5.11 m

