

15 Chestnut Avenue

Ground Floor

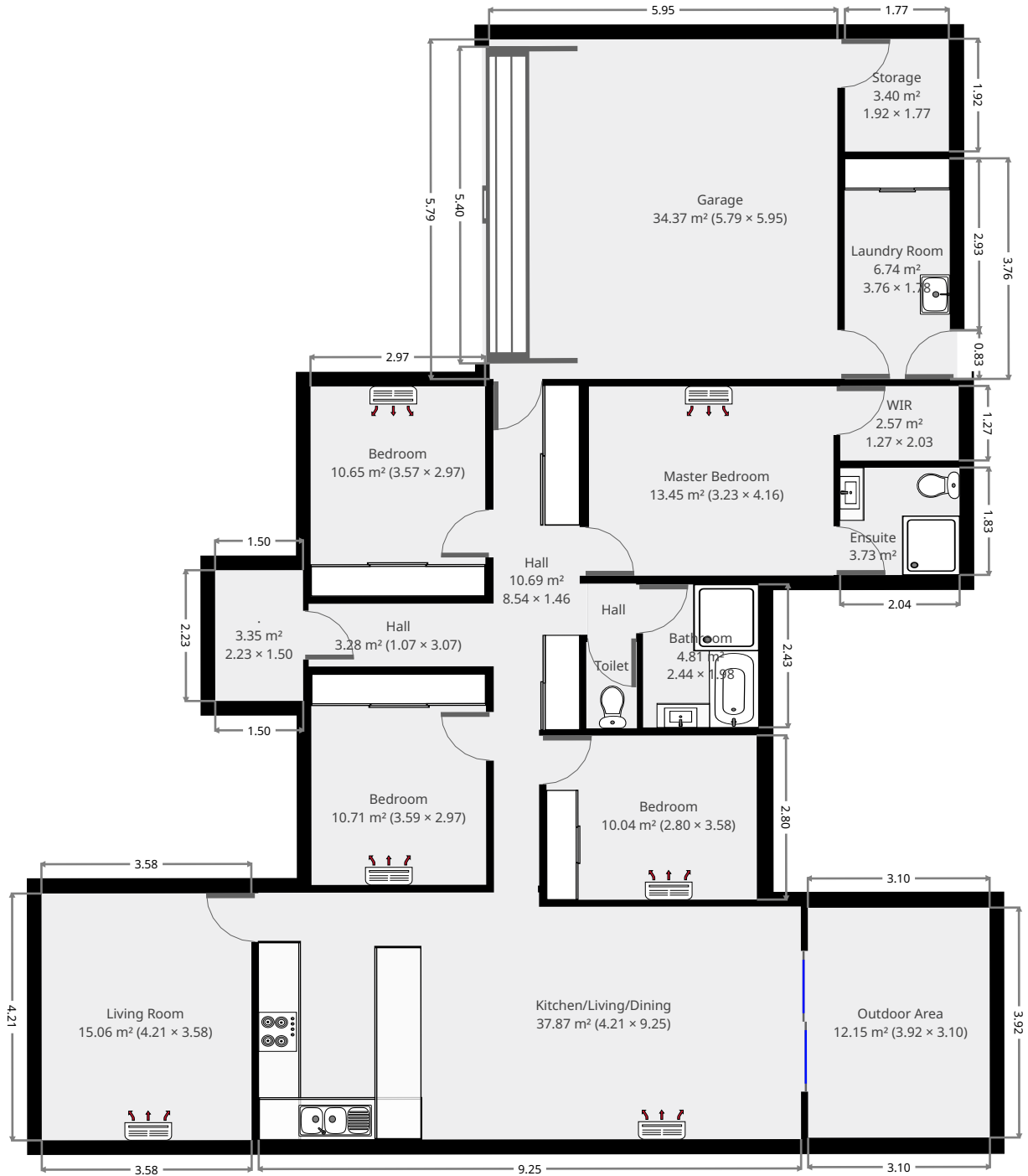

THIS FLOORPLAN IS PROVIDED WITHOUT WARRANTY OF ANY KIND. SENSOPIA DISCLAIMS ANY WARRANTY INCLUDING, WITHOUT LIMITATION, SATISFACTORY QUALITY OR ACCURACY OF DIMENSIONS.



15 Chestnut Avenue

WIR

Width: 1.27 m
 Length: 2.03 m
 Area: 2.57 m²
 Perimeter: 6.58 m

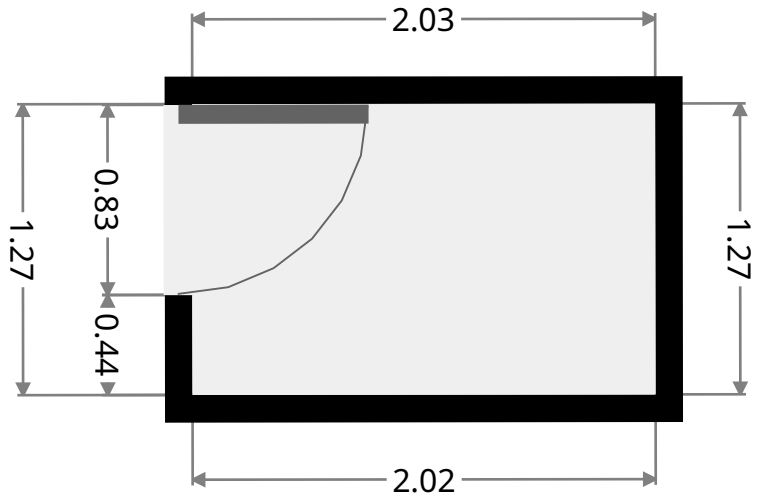
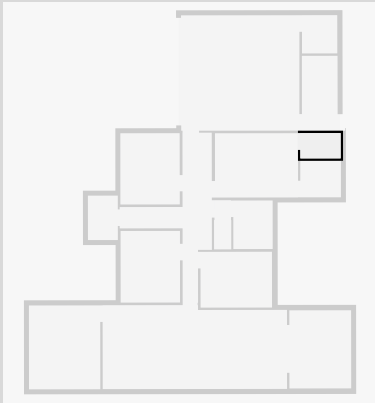

•
 Width: 1.50 m
 Length: 2.23 m
 Area: 3.35 m²
 Perimeter: 7.46 m

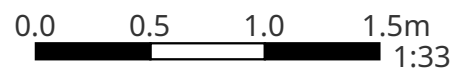
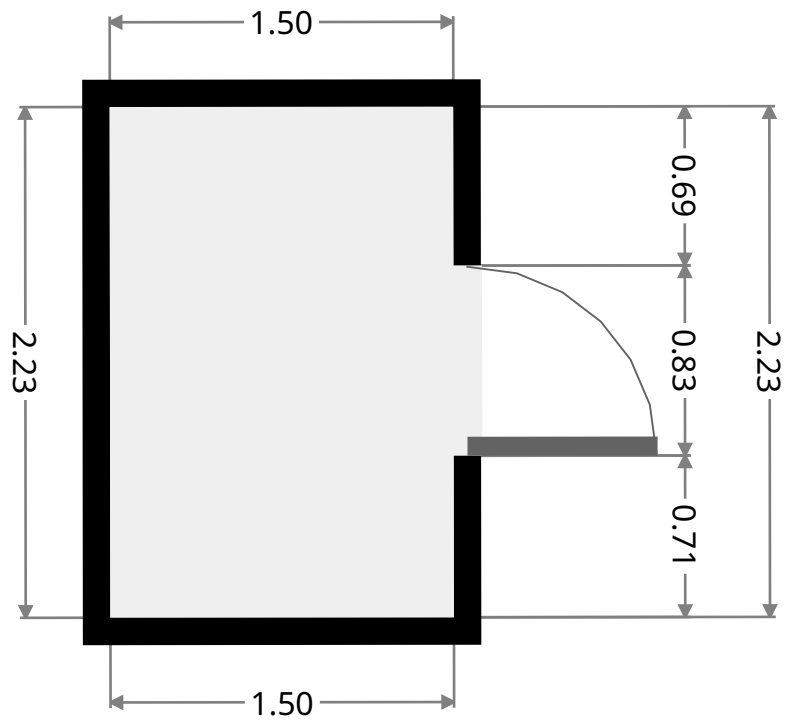
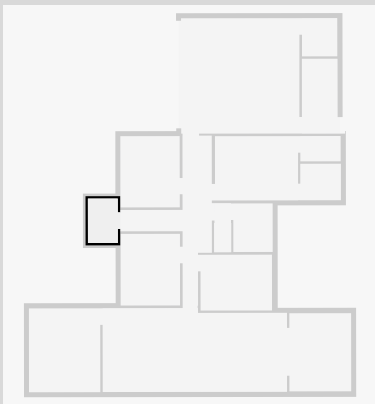

15 Chestnut Avenue

Outdoor Area

Width: 3.10 m
 Length: 3.92 m
 Area: 12.15 m²
 Perimeter: 14.04 m

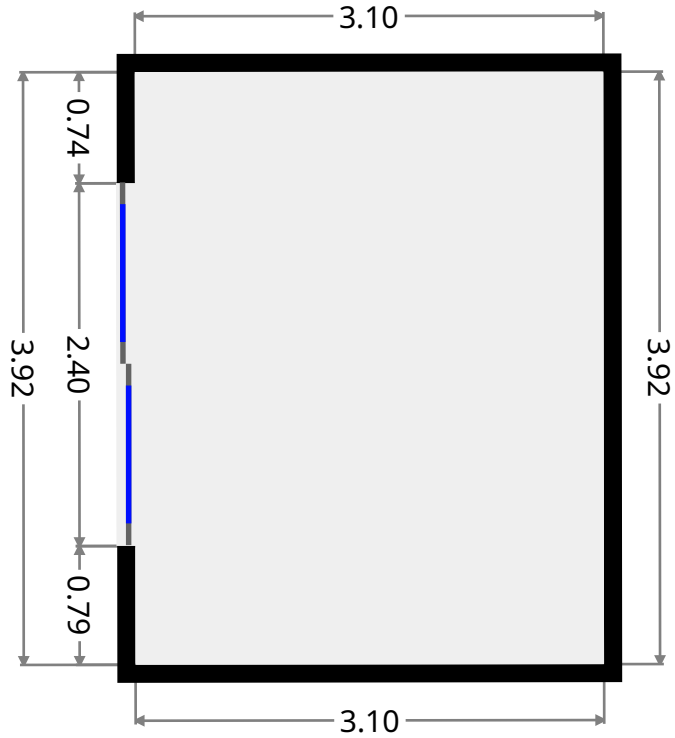
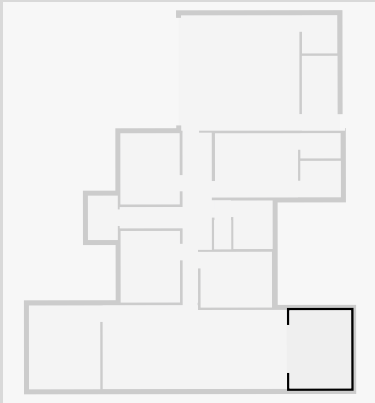

Living Room

Width: 3.58 m
 Length: 4.21 m
 Area: 15.06 m²
 Perimeter: 15.58 m

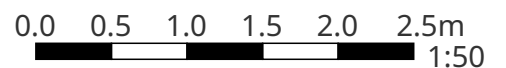
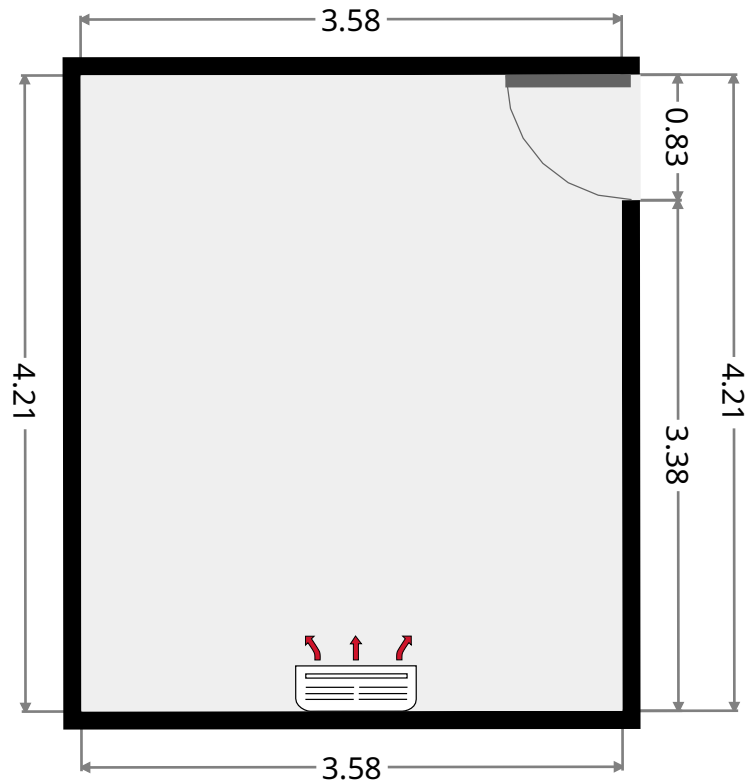
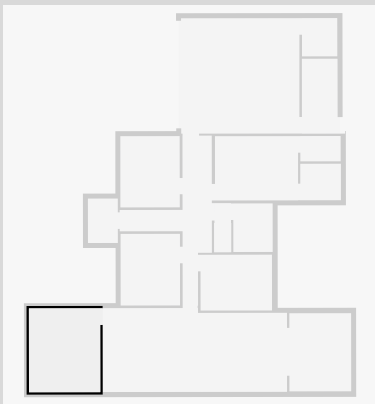

THIS FLOORPLAN IS PROVIDED WITHOUT WARRANTY OF ANY KIND. SENSOPIA DISCLAIMS ANY WARRANTY INCLUDING, WITHOUT LIMITATION, SATISFACTORY QUALITY OR ACCURACY OF DIMENSIONS.

15 Chestnut Avenue

Laundry Room

Width: 1.78 m
Length: 3.76 m
Area: 6.74 m²
Perimeter: 11.11 m

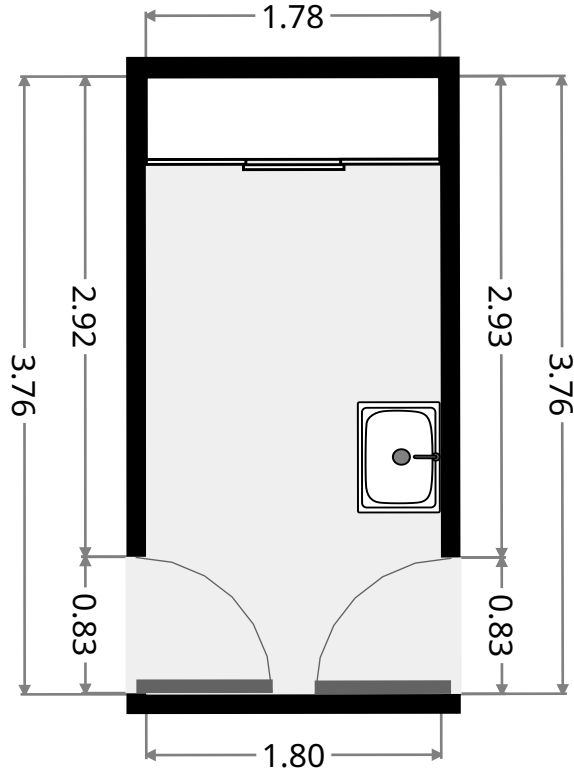
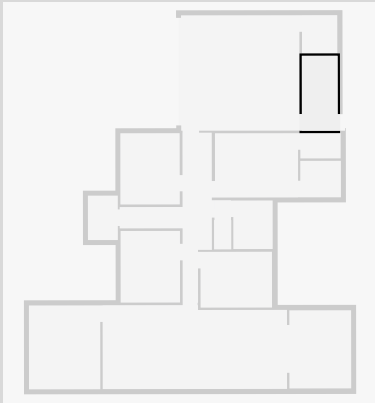

Storage

Width: 1.77 m
Length: 1.92 m
Area: 3.40 m²
Perimeter: 7.38 m

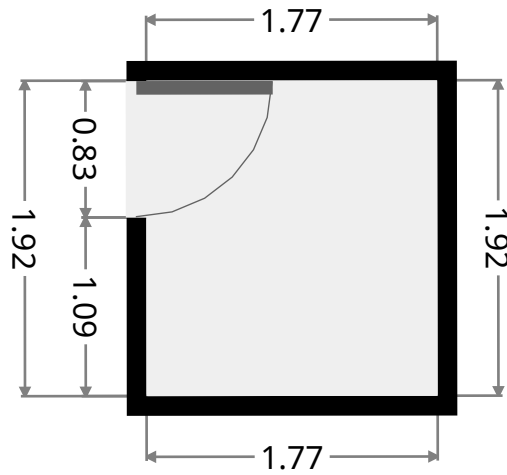
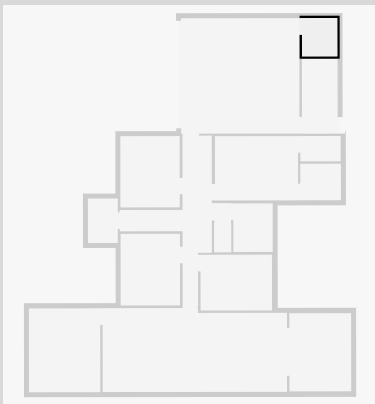

15 Chestnut Avenue

Garage

Width: 5.79 m
 Length: 5.95 m
 Area: 34.37 m²
 Perimeter: 23.45 m

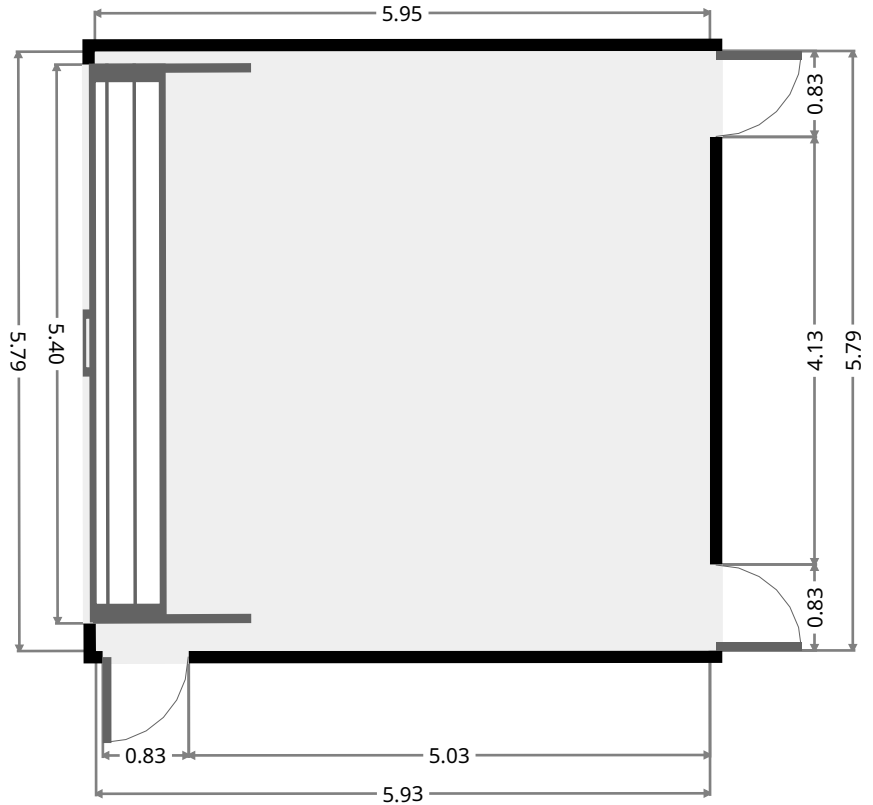
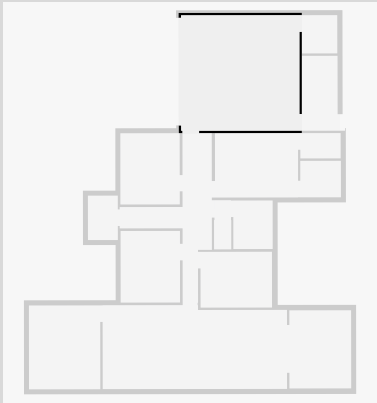

Bedroom

Width: 2.97 m
 Length: 3.57 m
 Area: 10.65 m²
 Perimeter: 13.11 m

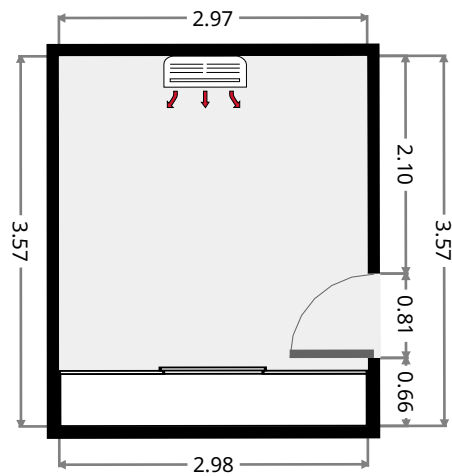
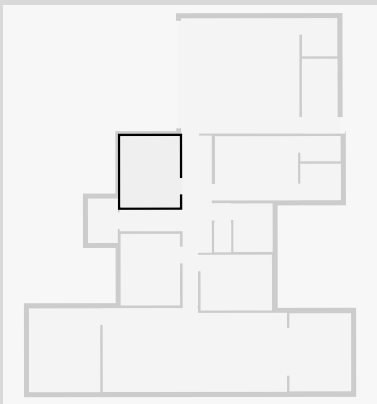

THIS FLOORPLAN IS PROVIDED WITHOUT WARRANTY OF ANY KIND. SENSOPIA DISCLAIMS ANY WARRANTY INCLUDING, WITHOUT LIMITATION, SATISFACTORY QUALITY OR ACCURACY OF DIMENSIONS.



15 Chestnut Avenue

Ensuite

Width: 1.83 m
Length: 2.04 m
Area: 3.73 m²
Perimeter: 7.74 m

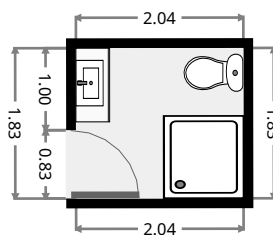
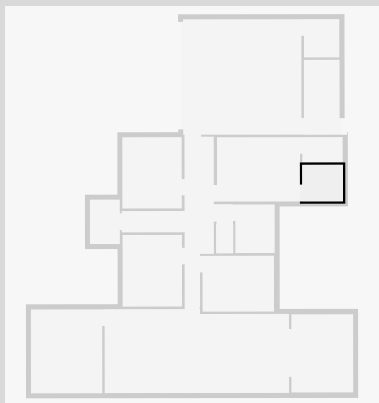

Kitchen/Living/Dining

Width: 4.21 m
Length: 9.25 m
Area: 37.87 m²
Perimeter: 26.93 m

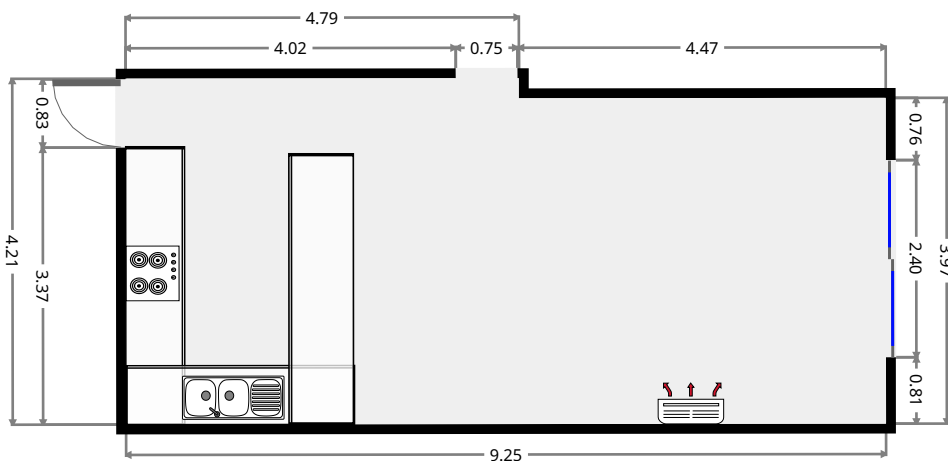
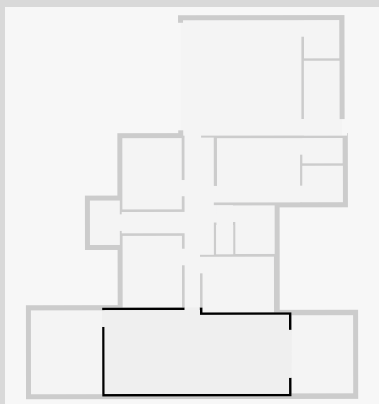

THIS FLOORPLAN IS PROVIDED WITHOUT WARRANTY OF ANY KIND. SENSOPIA DISCLAIMS ANY WARRANTY INCLUDING, WITHOUT LIMITATION, SATISFACTORY QUALITY OR ACCURACY OF DIMENSIONS.

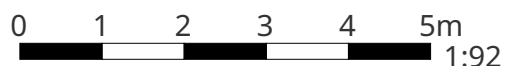

15 Chestnut Avenue

Master Bedroom

Width: 3.23 m
Length: 4.16 m
Area: 13.45 m²
Perimeter: 14.79 m

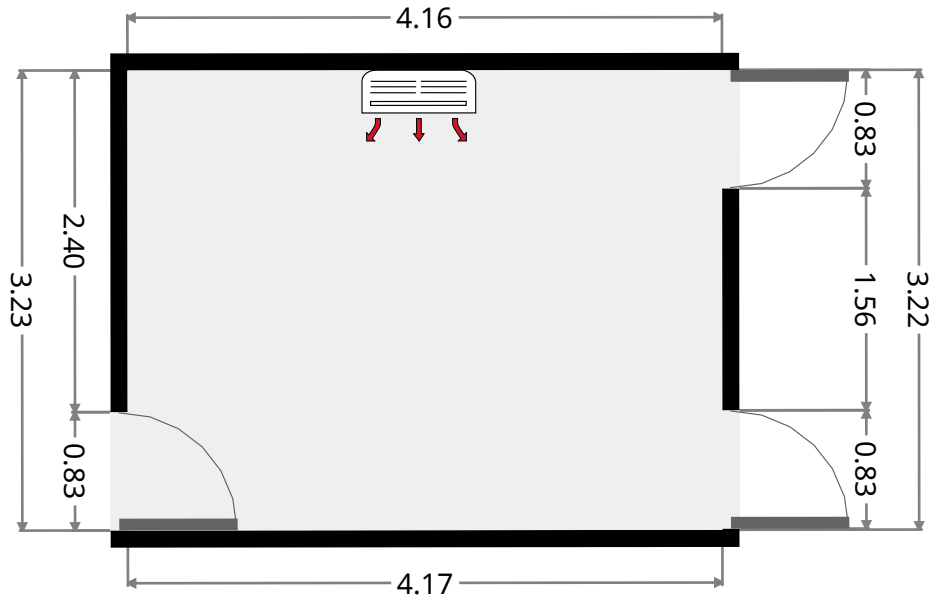
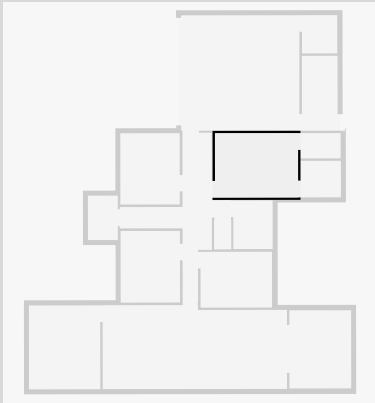

Bathroom

Width: 1.98 m
Length: 2.44 m
Area: 4.81 m²
Perimeter: 8.82 m

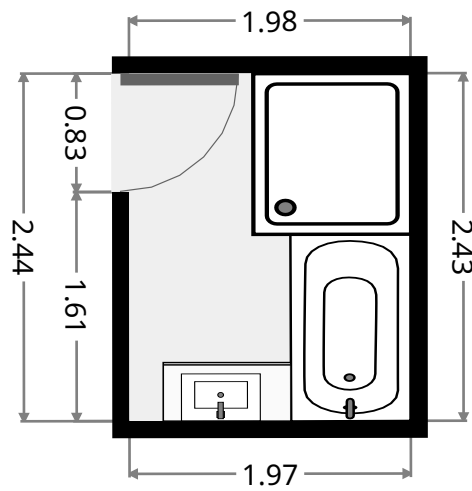
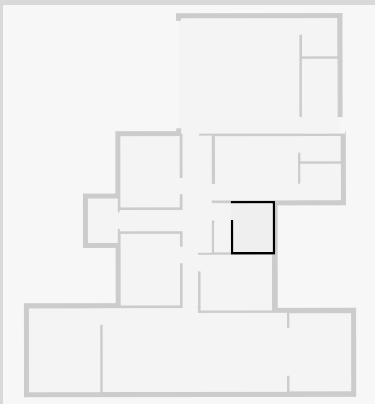

15 Chestnut Avenue

Hall

Width: 0.83 m
Length: 0.87 m
Area: 0.72 m²
Perimeter: 3.41 m

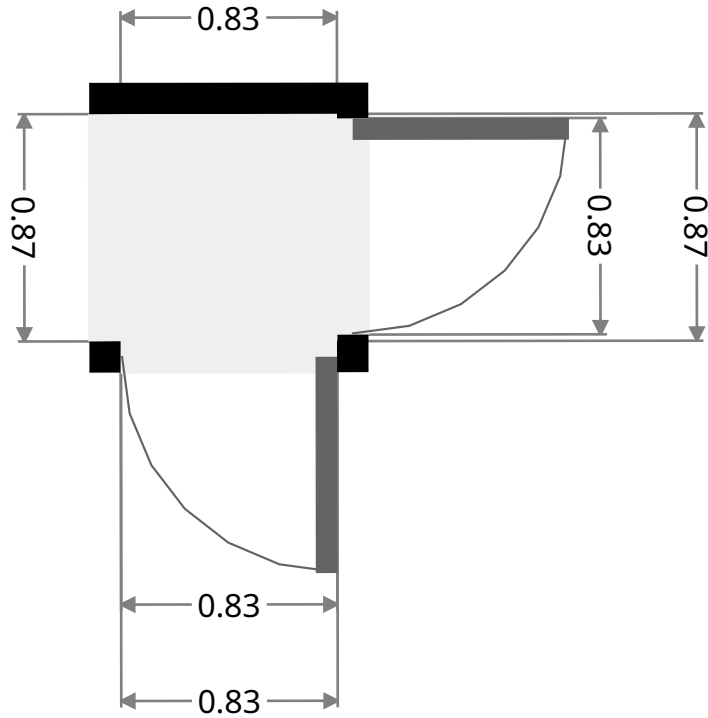
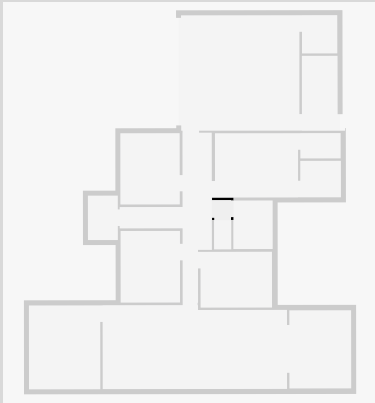

Toilet

Width: 0.87 m
Length: 1.47 m
Area: 1.27 m²
Perimeter: 4.67 m

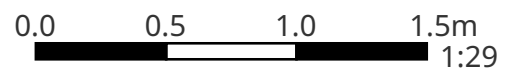
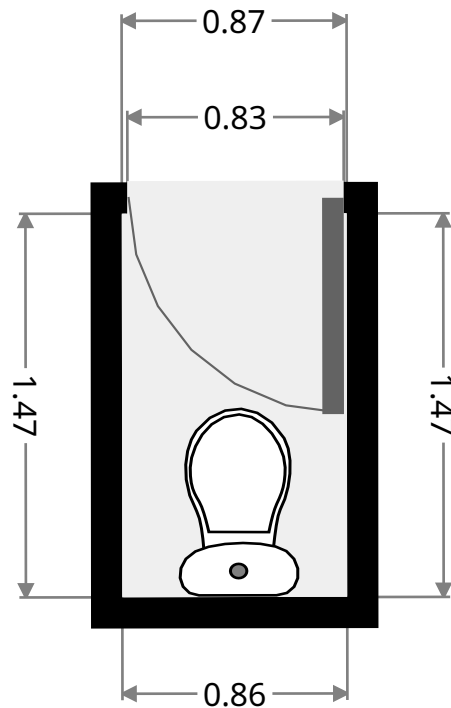
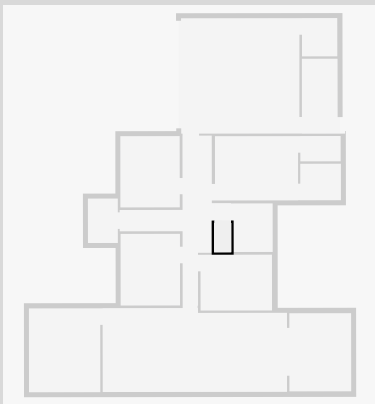

THIS FLOORPLAN IS PROVIDED WITHOUT WARRANTY OF ANY KIND. SENSOPIA DISCLAIMS ANY WARRANTY INCLUDING, WITHOUT LIMITATION, SATISFACTORY QUALITY OR ACCURACY OF DIMENSIONS.

15 Chestnut Avenue

Hall

Width: 1.07 m
Length: 3.07 m
Area: 3.28 m²
Perimeter: 8.26 m

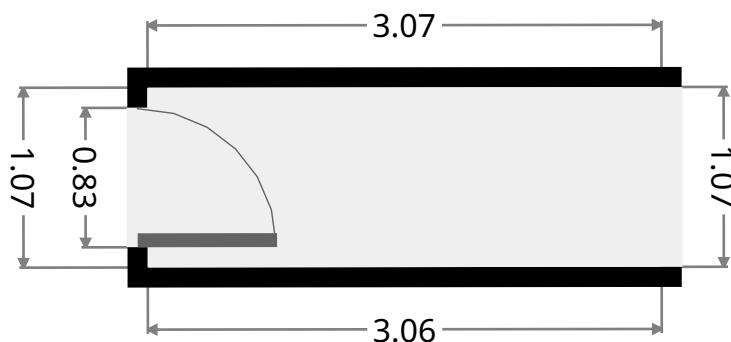
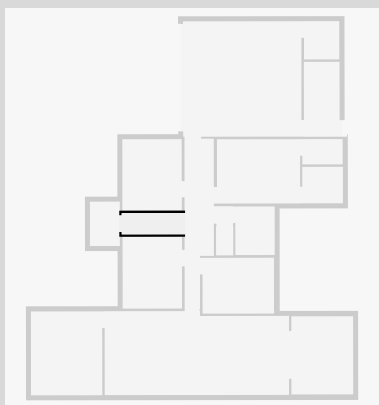

Bedroom

Width: 2.97 m
Length: 3.59 m
Area: 10.71 m²
Perimeter: 13.15 m

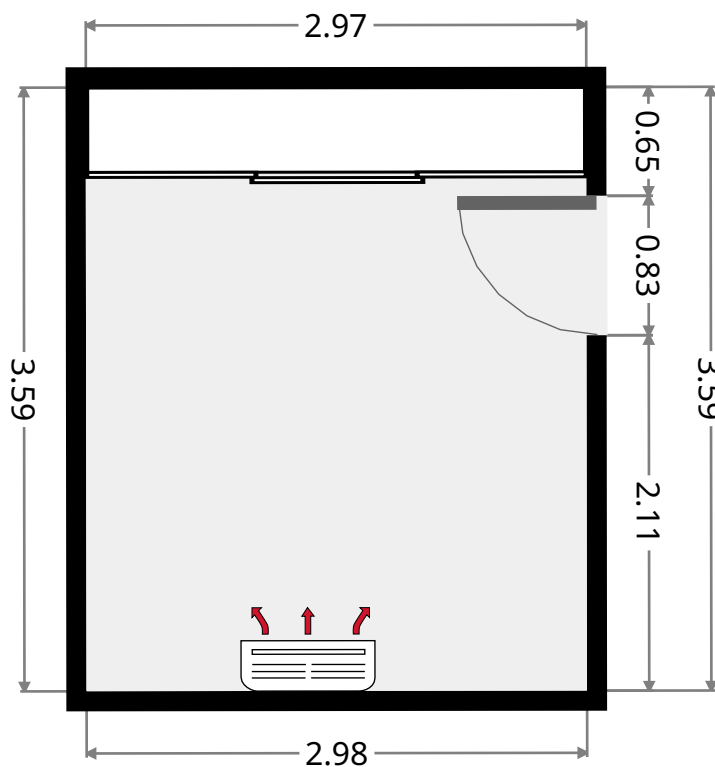
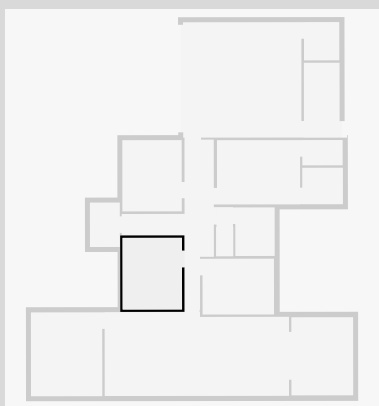

15 Chestnut Avenue

Bedroom

Width: 2.80 m
 Length: 3.58 m
 Area: 10.04 m²
 Perimeter: 12.77 m

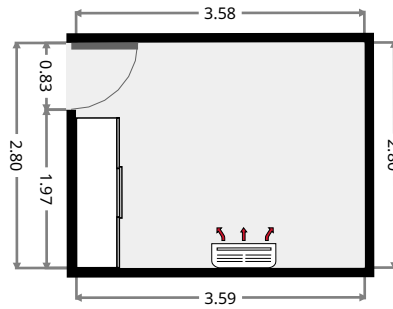
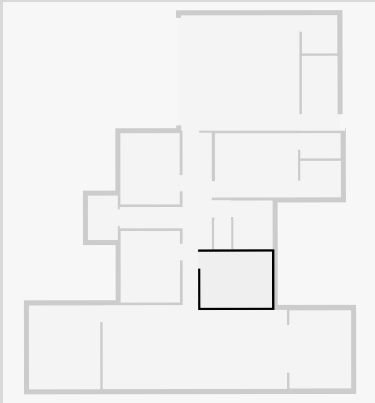

Hall

Width: 1.46 m
 Length: 8.54 m
 Area: 10.69 m²
 Perimeter: 20.01 m

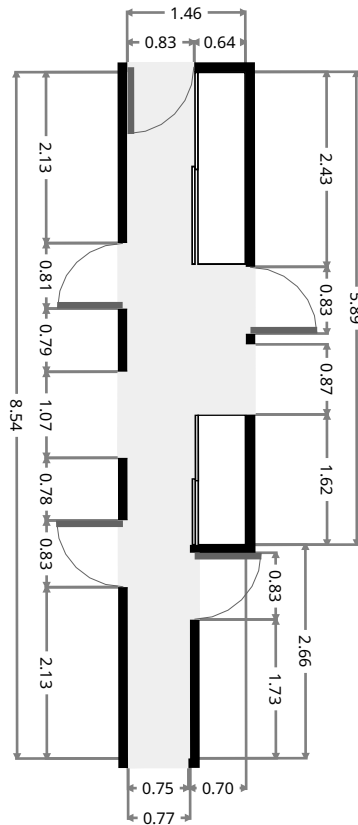
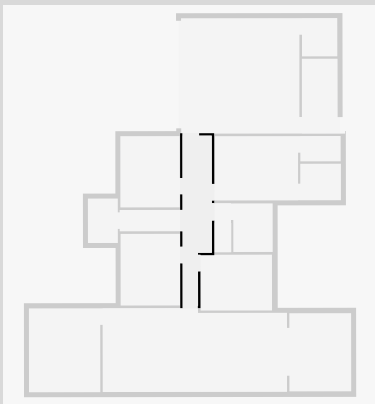

THIS FLOORPLAN IS PROVIDED WITHOUT WARRANTY OF ANY KIND. SENSOPIA DISCLAIMS ANY WARRANTY INCLUDING, WITHOUT LIMITATION, SATISFACTORY QUALITY OR ACCURACY OF DIMENSIONS.