

15 Bertram Street

Ground Floor

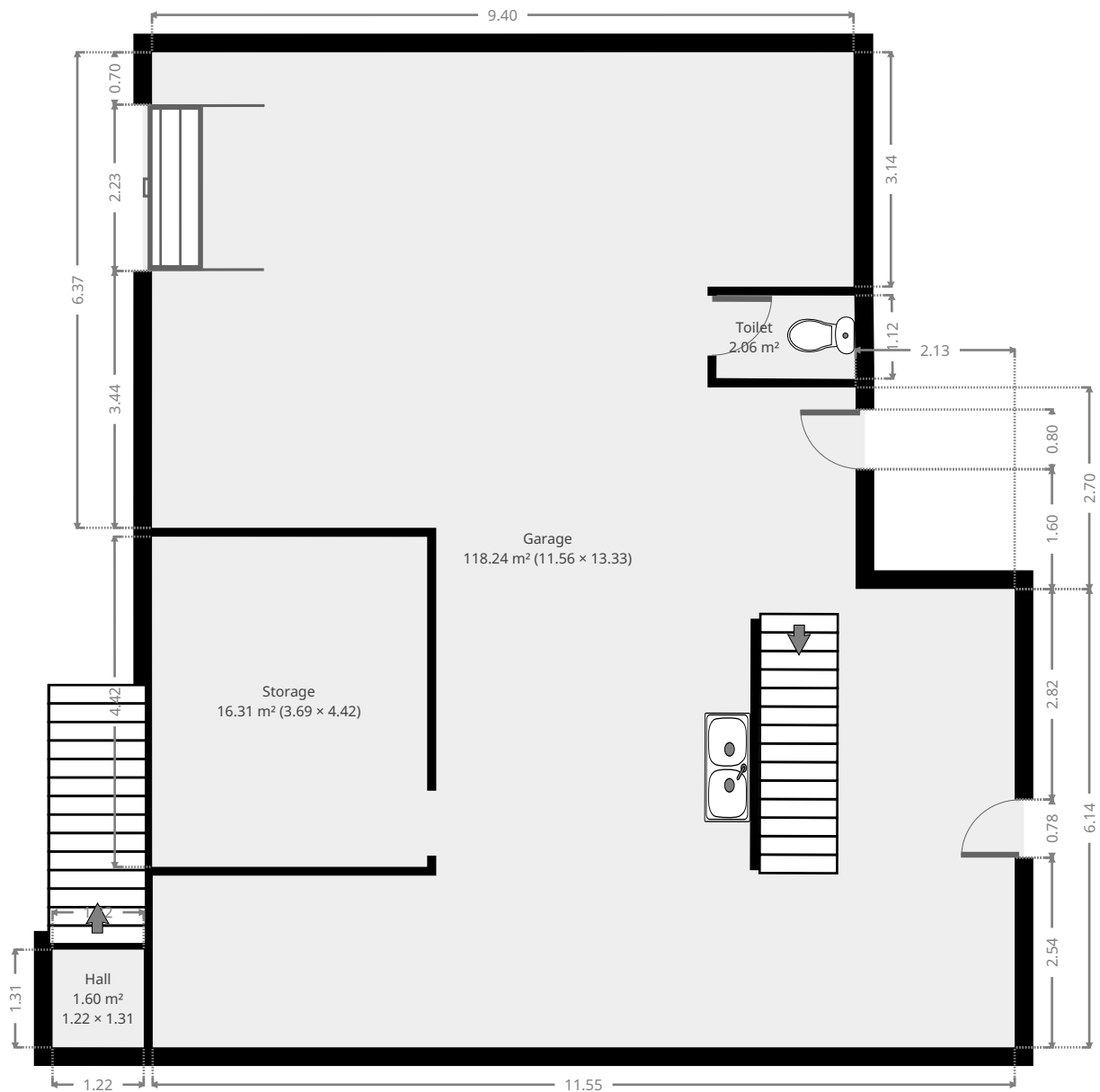

THIS FLOORPLAN IS PROVIDED WITHOUT WARRANTY OF ANY KIND. SENSOPIA DISCLAIMS ANY WARRANTY INCLUDING, WITHOUT LIMITATION, SATISFACTORY QUALITY OR ACCURACY OF DIMENSIONS.



15 Bertram Street

Garage

Width:	11.56 m
Length:	13.33 m
Area	118.24 m ²
Perimeter	61.29 m

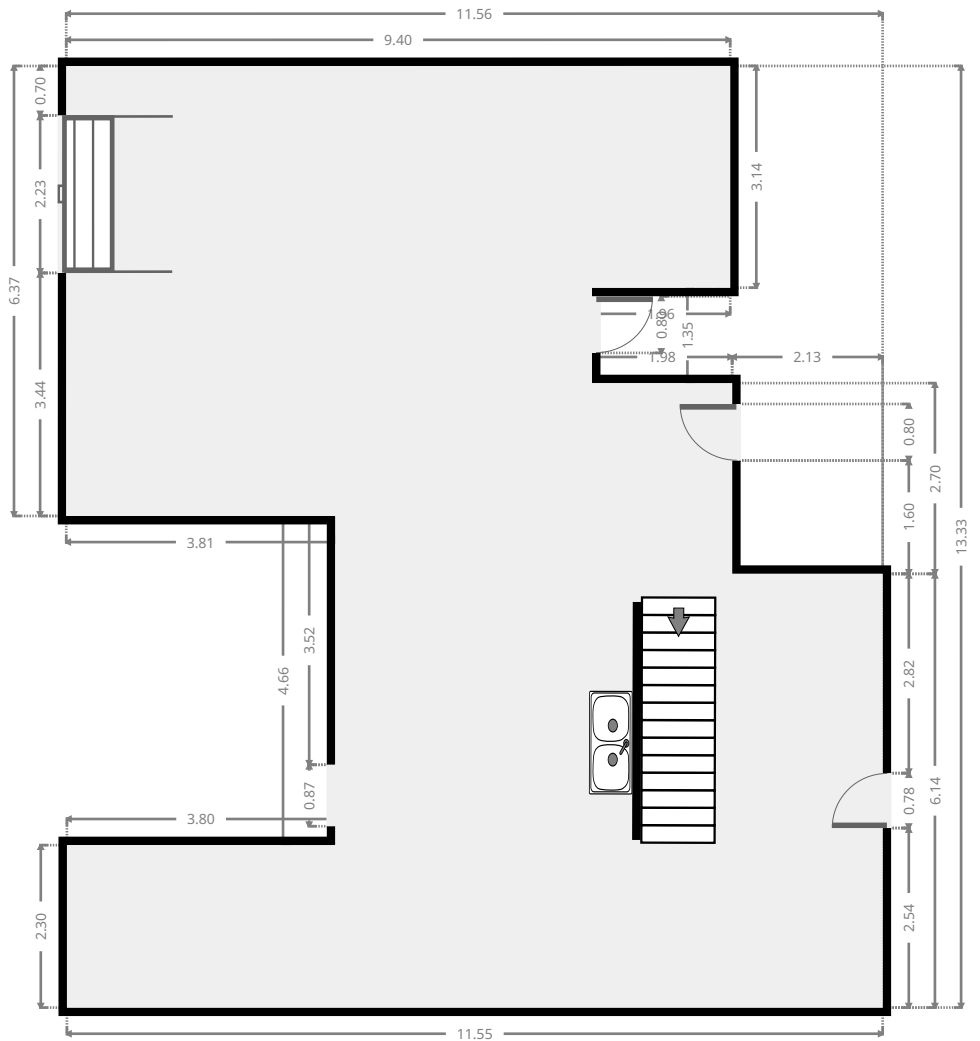
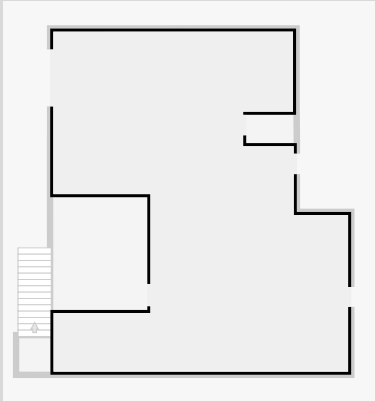

THIS FLOORPLAN IS PROVIDED WITHOUT WARRANTY OF ANY KIND. SENSOPIA DISCLAIMS ANY WARRANTY INCLUDING, WITHOUT LIMITATION, SATISFACTORY QUALITY OR ACCURACY OF DIMENSIONS.

15 Bertram Street

Storage

Width: 3.69 m
Length: 4.42 m
Area: 16.31 m²
Perimeter: 16.22 m

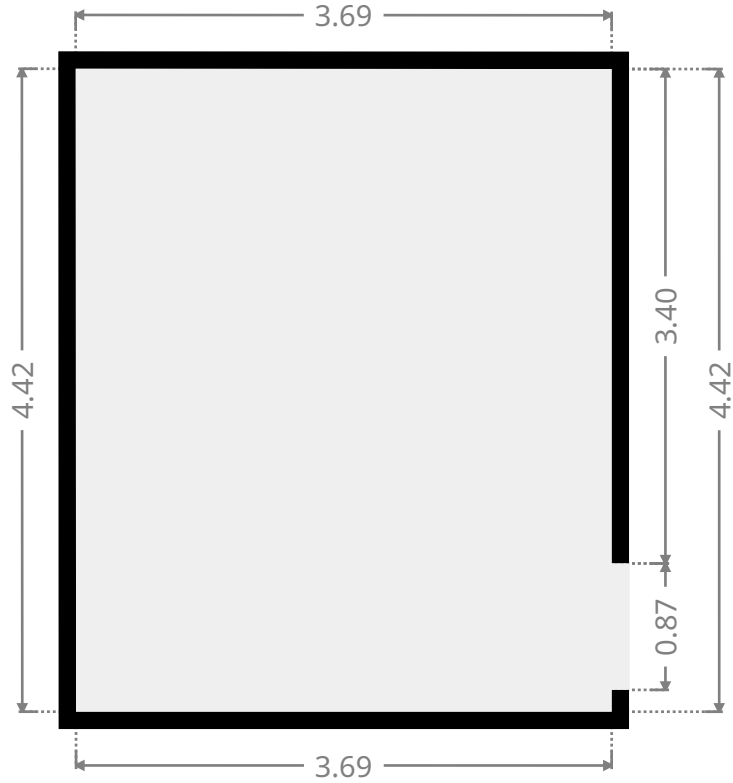
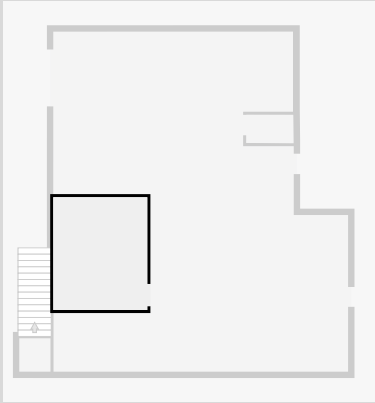

Toilet / Half Bath

Width: 1.12 m
Length: 1.86 m
Area: 2.06 m²
Perimeter: 5.93 m

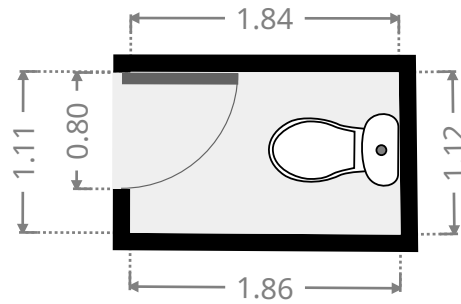
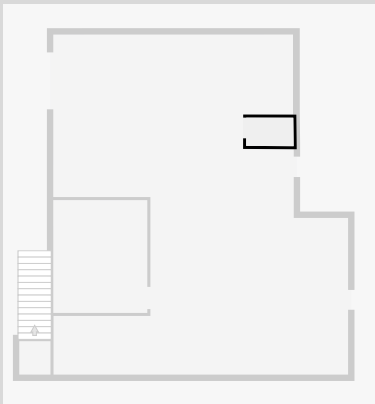

15 Bertram Street

Hall

Width:	1.22 m
Length:	1.31 m
Area	1.60 m ²
Perimeter	5.06 m

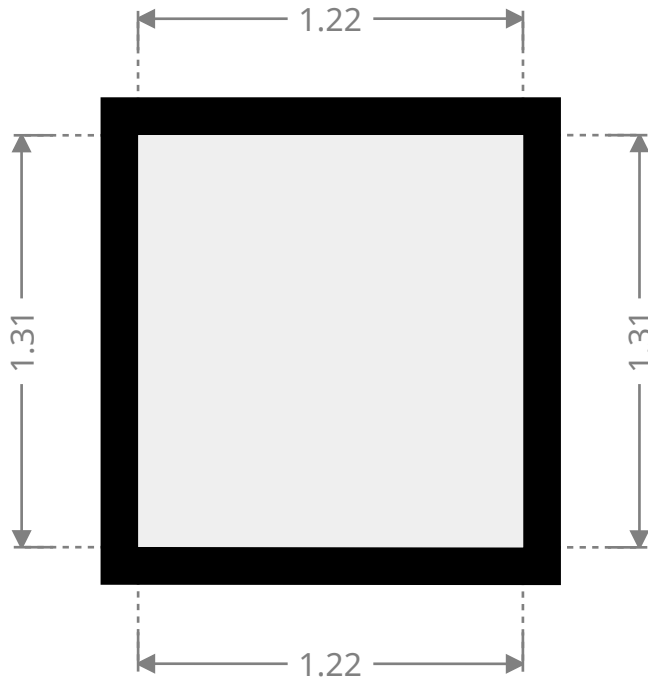
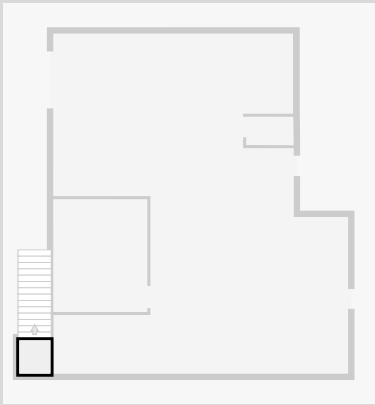

15 Bertram Street

1st Floor



THIS FLOORPLAN IS PROVIDED WITHOUT WARRANTY OF ANY KIND. SENSOPIA DISCLAIMS ANY WARRANTY INCLUDING, WITHOUT LIMITATION, SATISFACTORY QUALITY OR ACCURACY OF DIMENSIONS.



15 Bertram Street

Sunroom

Width: 1.66 m
 Length: 6.70 m
 Area: 11.12 m²
 Perimeter: 16.72 m

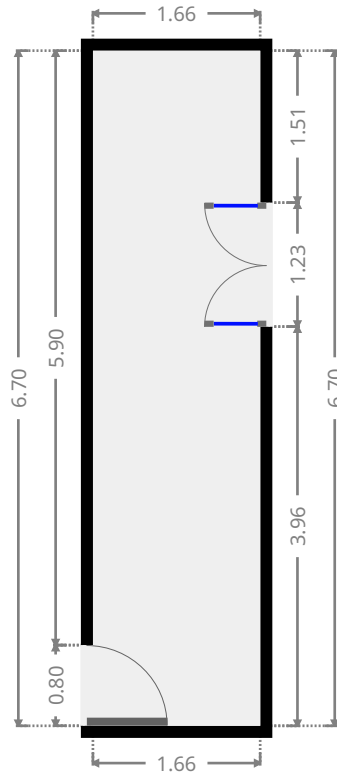
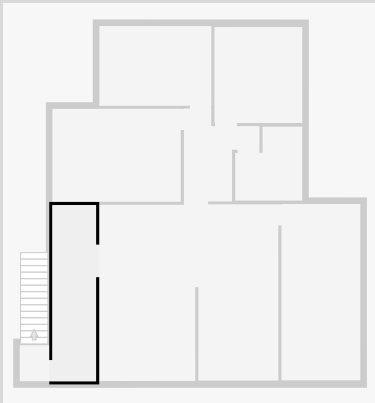

Living Room

Width: 3.65 m
 Length: 6.70 m
 Area: 24.46 m²
 Perimeter: 20.70 m

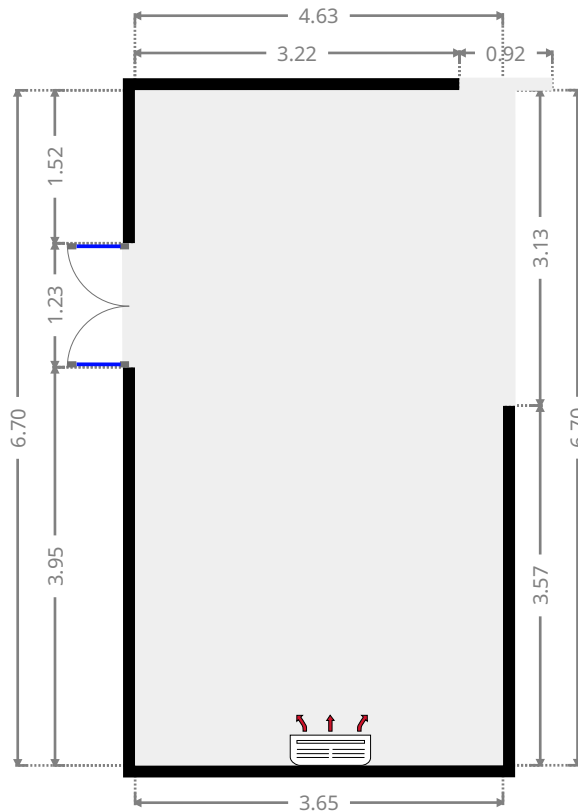
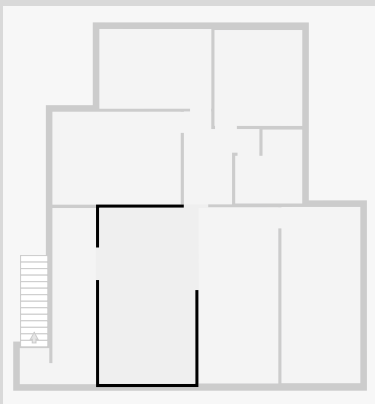

THIS FLOORPLAN IS PROVIDED WITHOUT WARRANTY OF ANY KIND. SENSOPIA DISCLAIMS ANY WARRANTY INCLUDING, WITHOUT LIMITATION, SATISFACTORY QUALITY OR ACCURACY OF DIMENSIONS.

15 Bertram Street

Kitchen

Width: 3.04 m
Length: 6.70 m
Area: 20.38 m²
Perimeter: 19.48 m

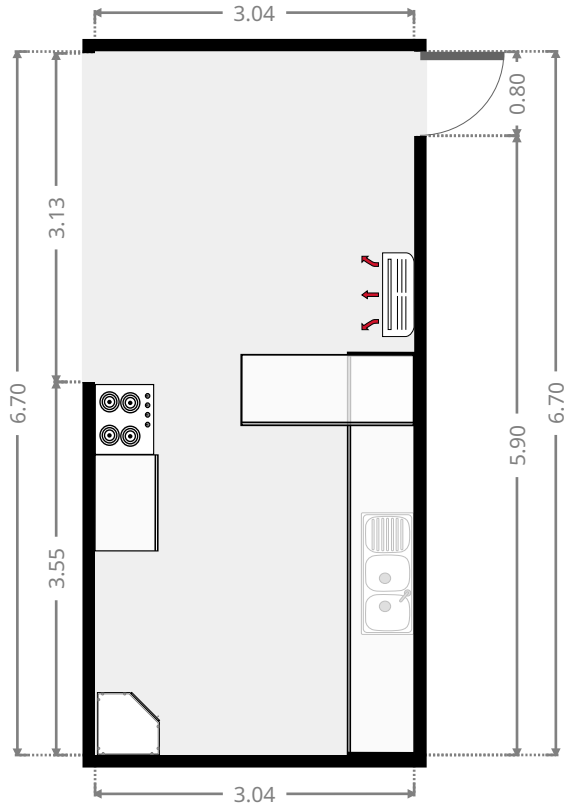
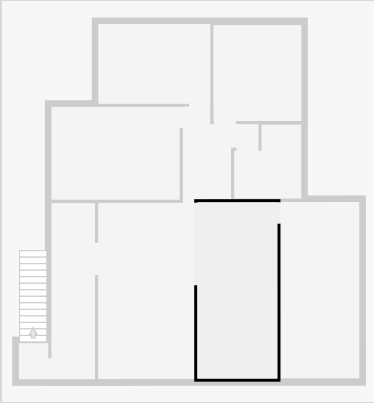

Stairway

Width: 3.00 m
Length: 6.70 m
Area: 20.11 m²
Perimeter: 19.41 m

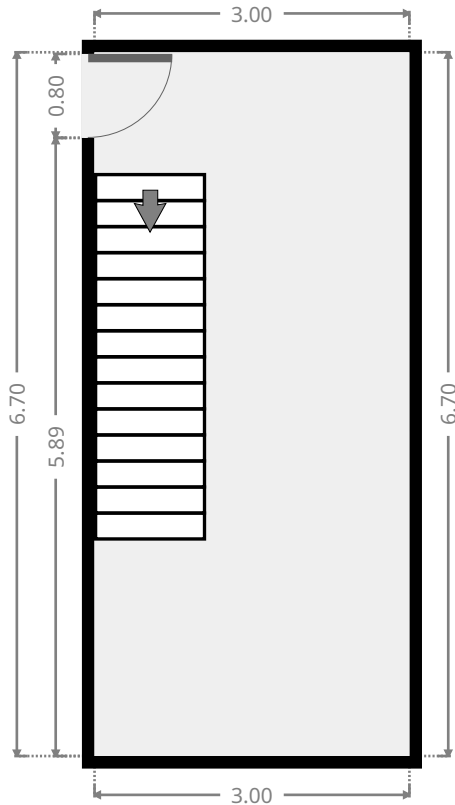
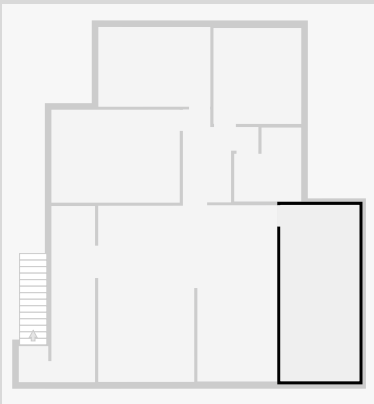

15 Bertram Street

Hall

Width: 2.87 m
 Length: 3.53 m
 Area: 6.88 m²
 Perimeter: 12.81 m

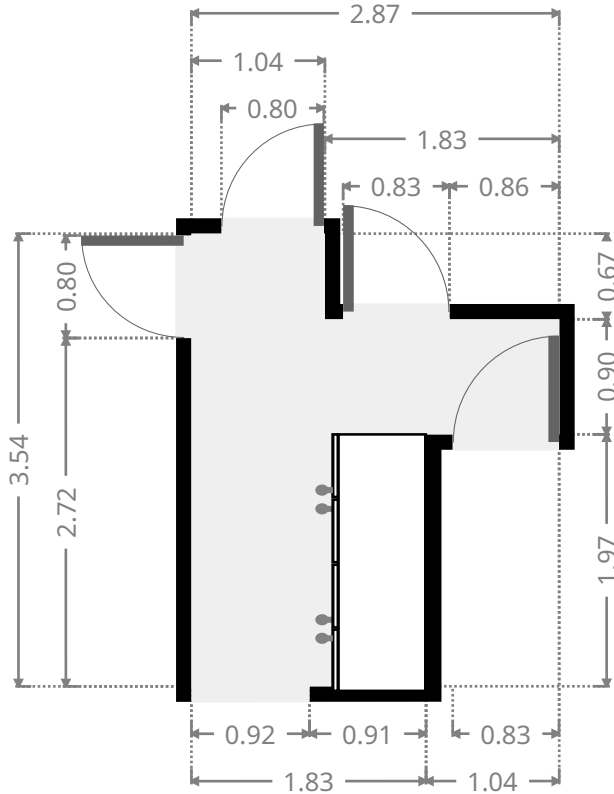
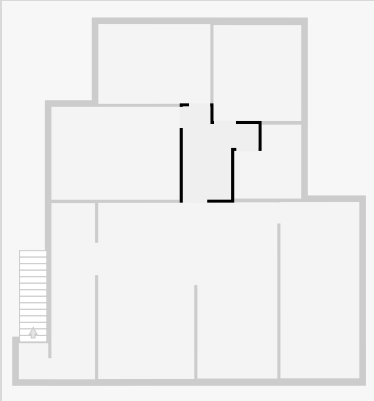

Bedroom

Width: 3.03 m
 Length: 4.26 m
 Area: 12.92 m²
 Perimeter: 14.58 m

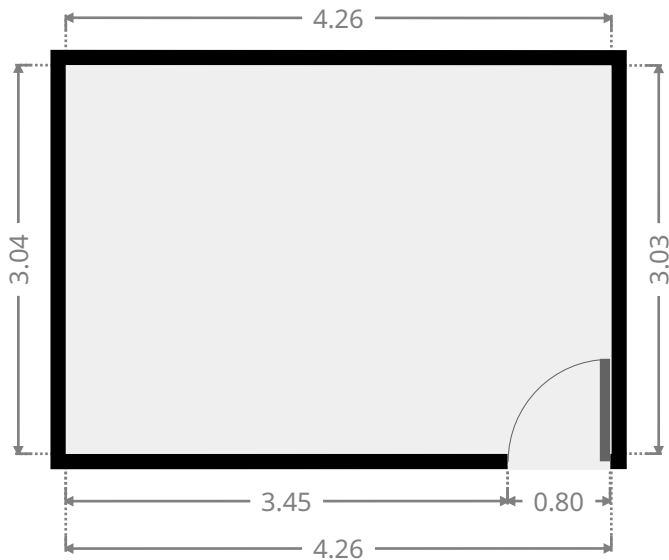
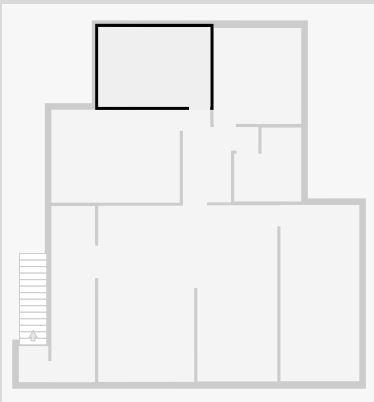

15 Bertram Street

Bedroom

Width: 3.53 m
 Length: 4.88 m
 Area: 17.25 m²
 Perimeter: 16.83 m

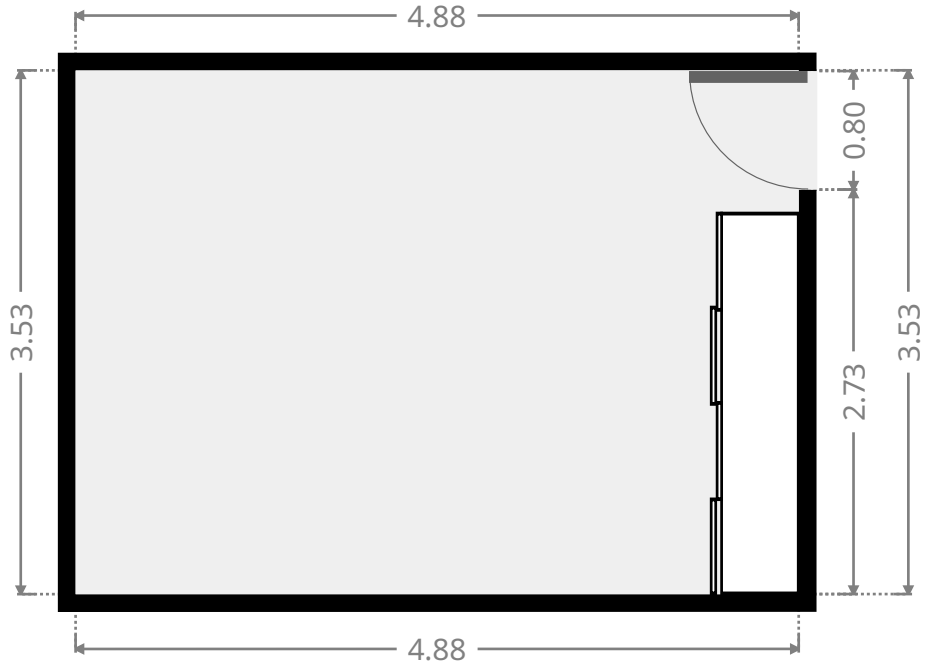
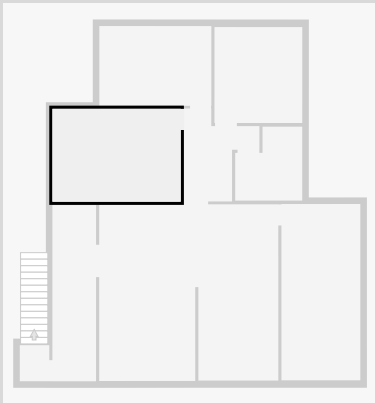

Bedroom

Width: 3.34 m
 Length: 3.65 m
 Area: 12.18 m²
 Perimeter: 13.97 m

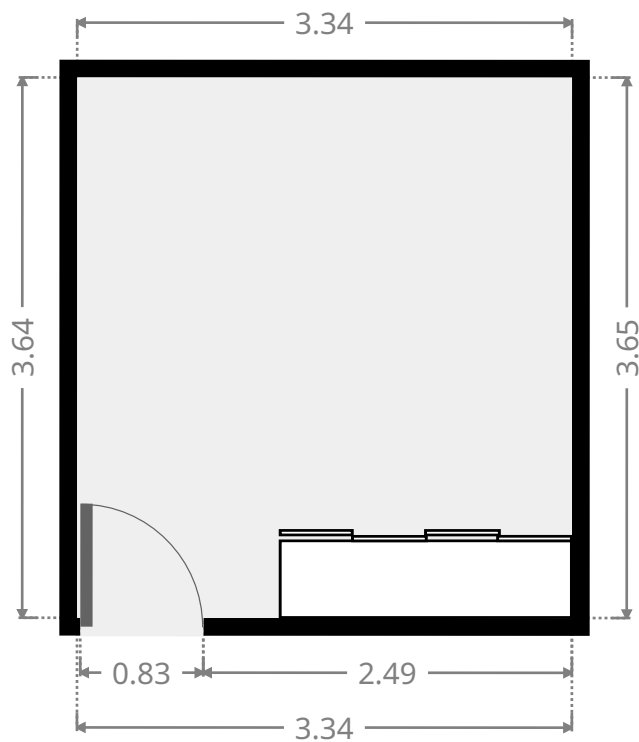
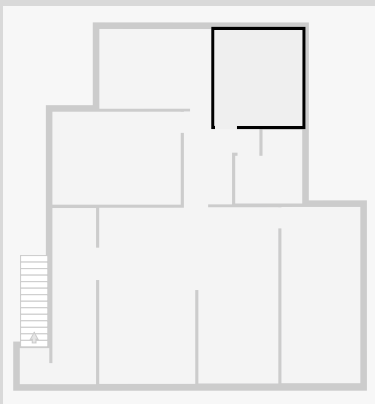

THIS FLOORPLAN IS PROVIDED WITHOUT WARRANTY OF ANY KIND. SENSOPIA DISCLAIMS ANY WARRANTY INCLUDING, WITHOUT LIMITATION, SATISFACTORY QUALITY OR ACCURACY OF DIMENSIONS.

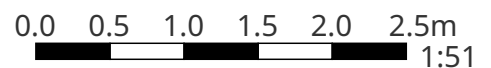

15 Bertram Street

Bathroom

Width: 2.55 m
 Length: 2.81 m
 Area: 6.13 m²
 Perimeter: 10.72 m

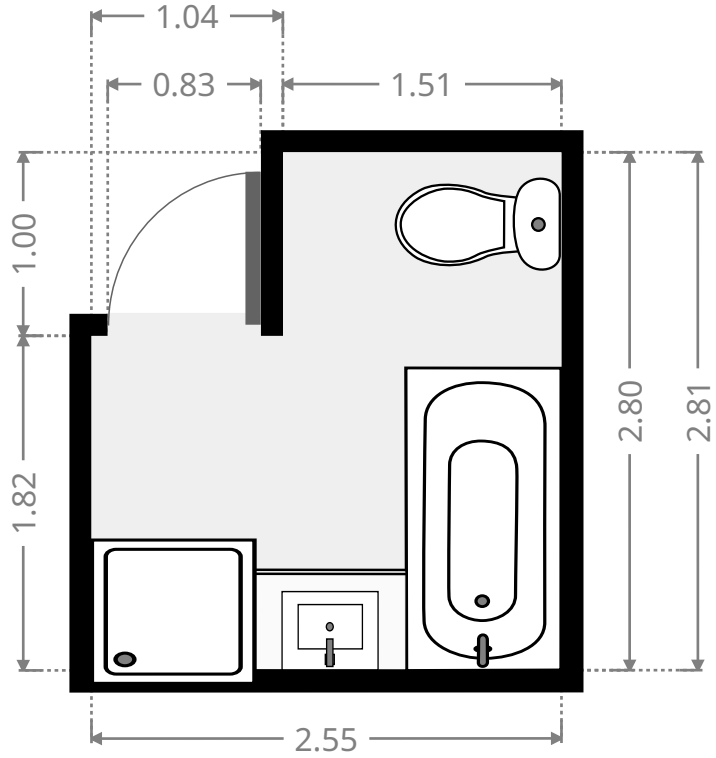
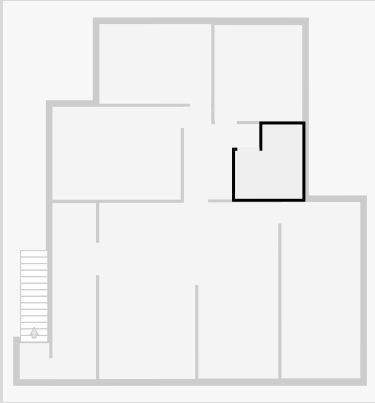

Hall

Width: 1.12 m
 Length: 1.37 m
 Area: 1.54 m²
 Perimeter: 4.98 m

