

147 Shepard Street

Created on
2020-09-29

Floors
1

▼ Ground Floor

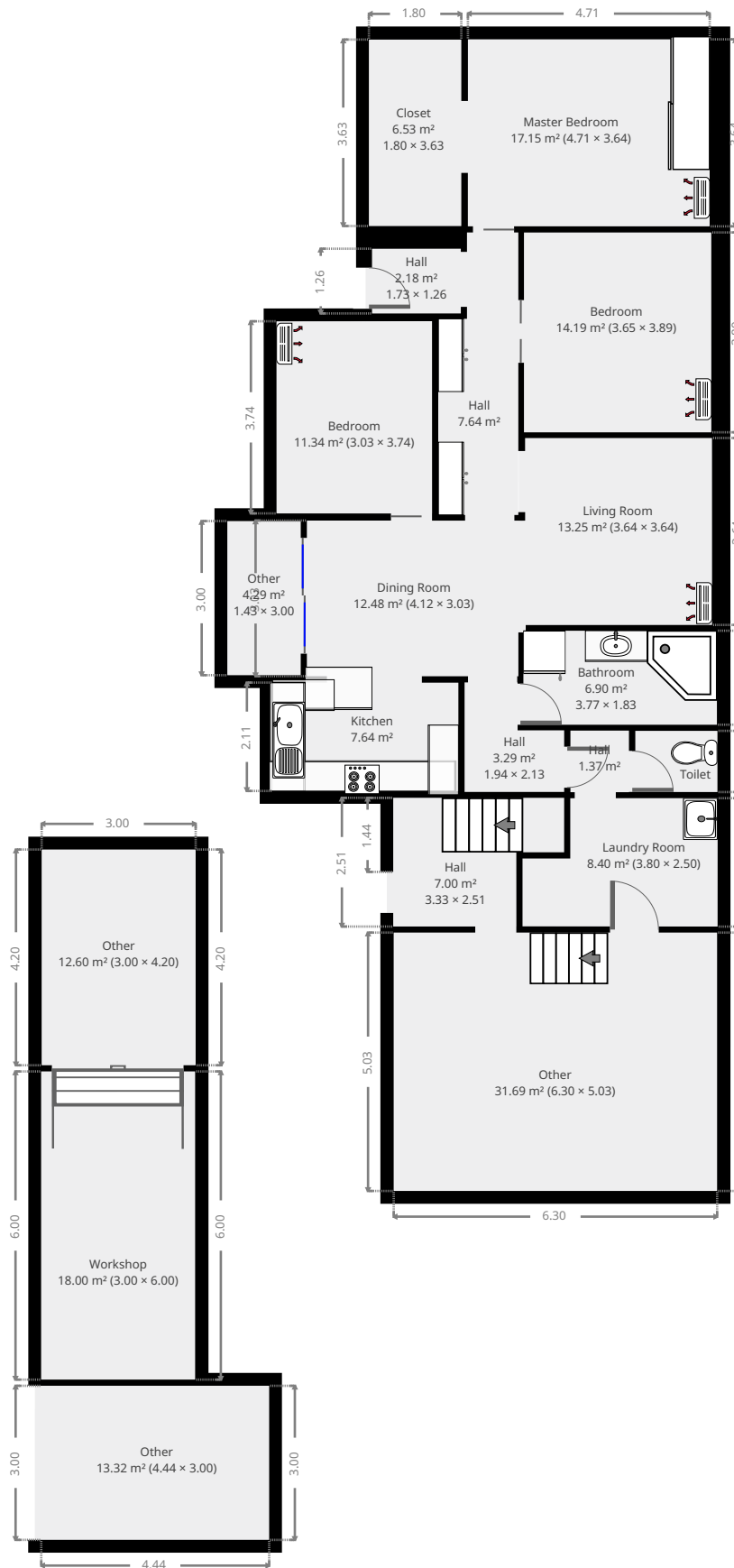

THIS FLOORPLAN IS PROVIDED WITHOUT WARRANTY OF ANY KIND. SENSOPIA DISCLAIMS ANY WARRANTY INCLUDING, WITHOUT LIMITATION, SATISFACTORY QUALITY OR ACCURACY OF DIMENSIONS.

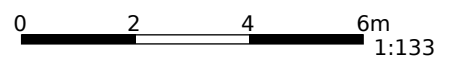

FLOORS: 1

▼ **Bathroom**
Ground Floor

WIDTH: 1.83 m • LENGTH: 3.77 m
AREA: 6.90 m² • PERIMETER: 11.20 m

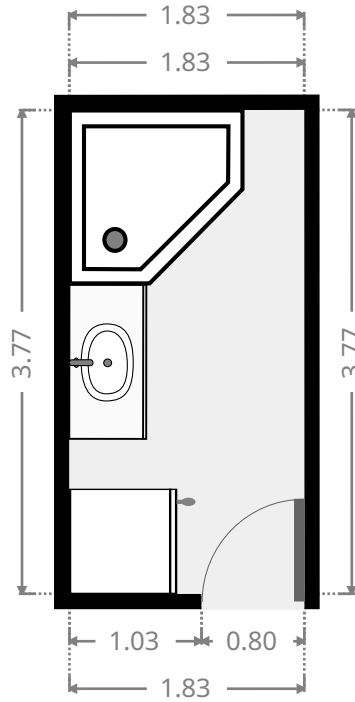
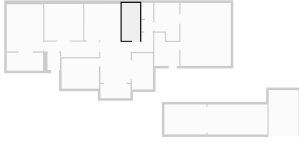

▼ **Other**
Ground Floor

WIDTH: 3.00 m • LENGTH: 4.44 m
AREA: 13.32 m² • PERIMETER: 14.88 m

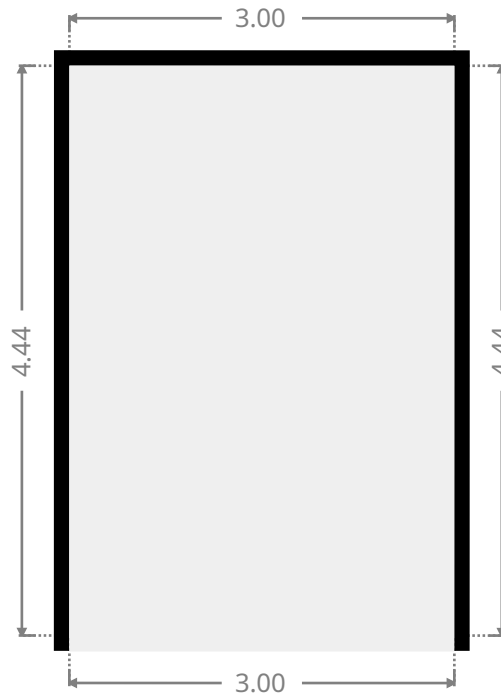

FLOORS: 1

▼ **Workshop**
Ground Floor

WIDTH: 6.00 m • **LENGTH:** 3.00 m
AREA: 18.00 m² • **PERIMETER:** 18.00 m

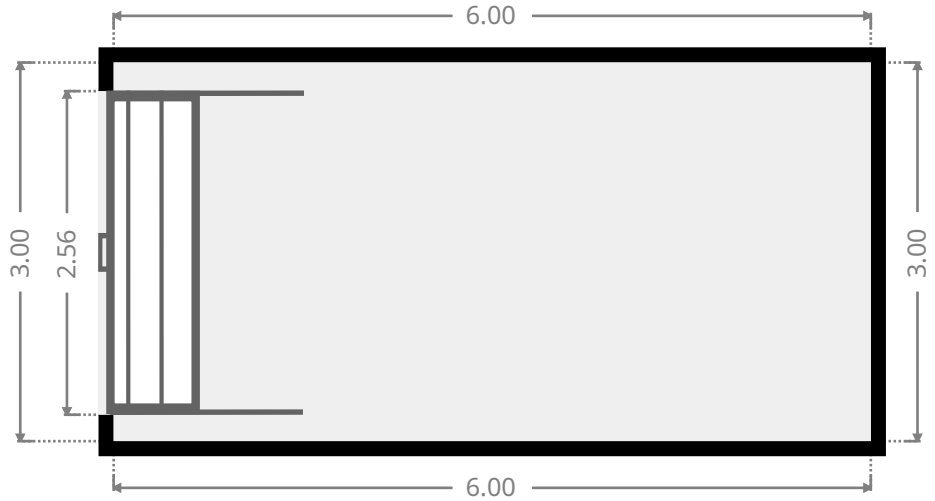
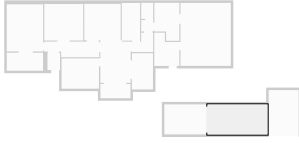

▼ **Other**
Ground Floor

WIDTH: 4.20 m • **LENGTH:** 3.00 m
AREA: 12.60 m² • **PERIMETER:** 14.40 m

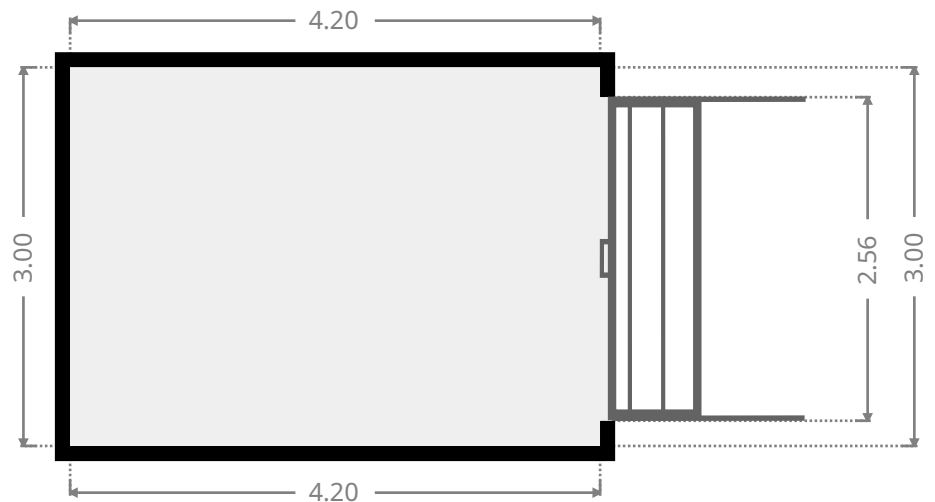
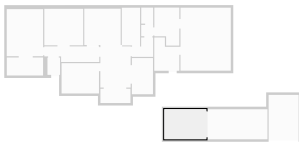

FLOORS: 1

▼ Other Ground Floor

WIDTH: 5.03 m • LENGTH: 6.30 m
AREA: 31.69 m² • PERIMETER: 22.66 m

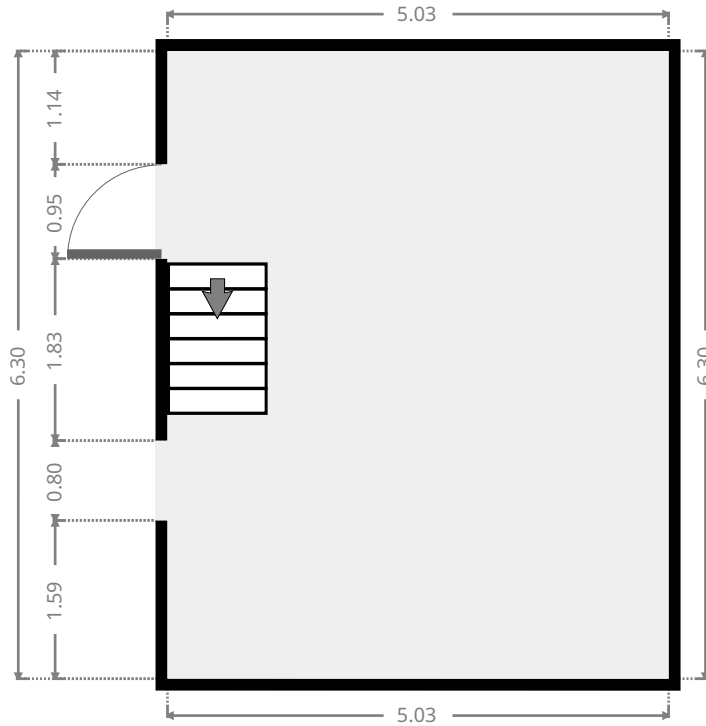
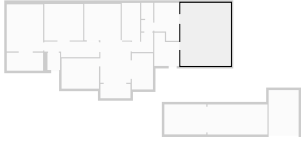

▼ Hall Ground Floor

WIDTH: 2.51 m • LENGTH: 3.33 m
AREA: 7.00 m² • PERIMETER: 11.67 m

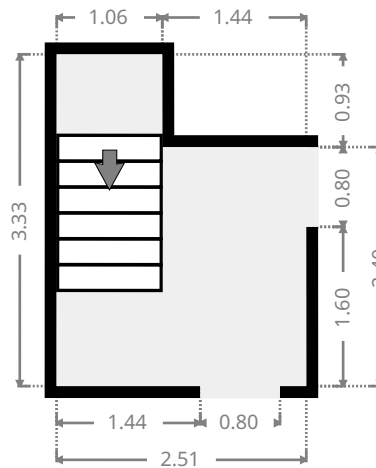
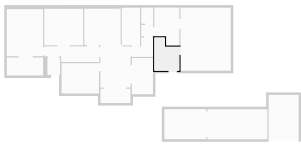

FLOORS: 1

▼ **Laundry Room**
Ground Floor

WIDTH: 2.50 m • LENGTH: 3.80 m
AREA: 8.40 m² • PERIMETER: 12.59 m

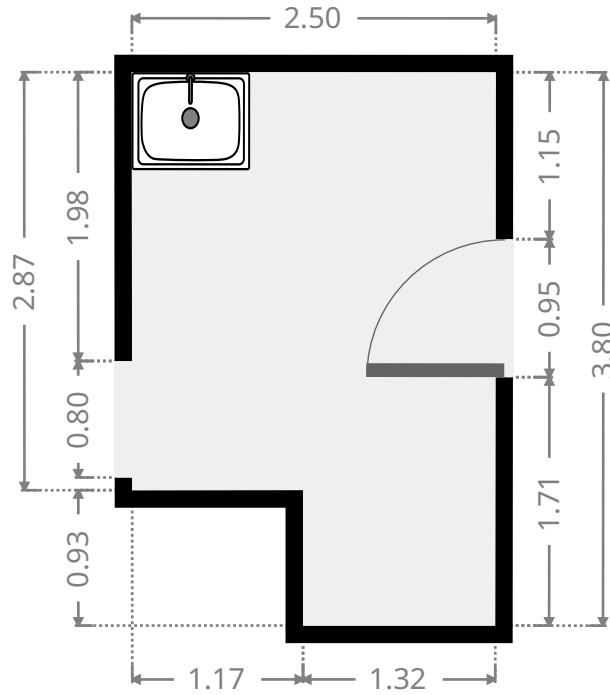
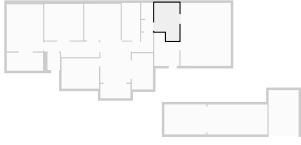

▼ **Toilet**
Ground Floor

WIDTH: 1.19 m • LENGTH: 1.60 m
AREA: 1.91 m² • PERIMETER: 5.58 m

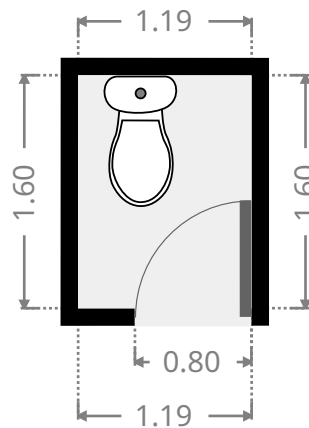
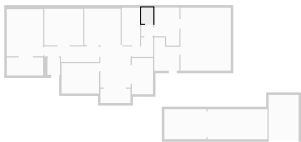

FLOORS: 1

▼ **Hall**
Ground Floor

WIDTH: 1.20 m • **LENGTH:** 1.14 m
AREA: 1.37 m² • **PERIMETER:** 4.68 m

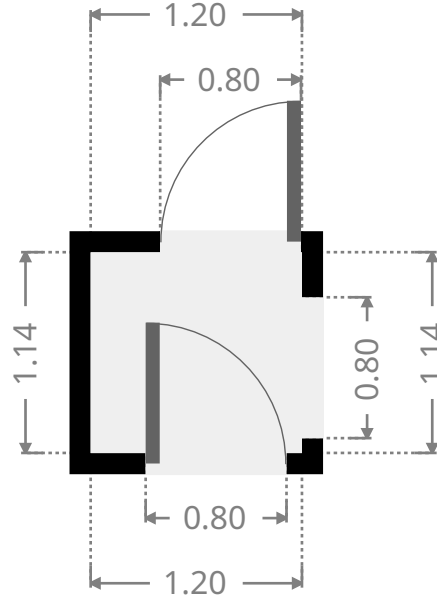
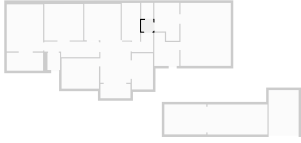

▼ **Hall**
Ground Floor

WIDTH: 2.13 m • **LENGTH:** 1.94 m
AREA: 3.29 m² • **PERIMETER:** 8.15 m

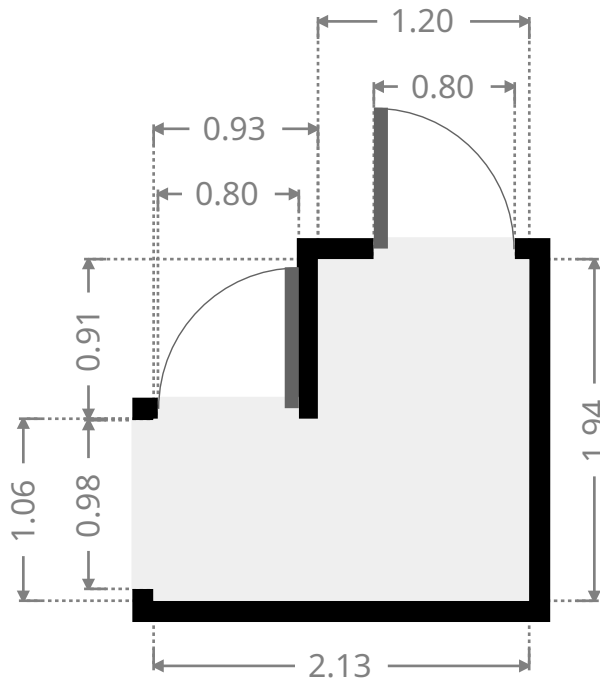
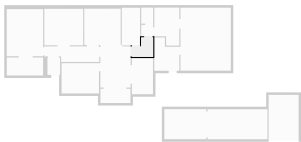

THIS FLOORPLAN IS PROVIDED WITHOUT WARRANTY OF ANY KIND. SENSOPIA DISCLAIMS ANY WARRANTY INCLUDING, WITHOUT LIMITATION, SATISFACTORY QUALITY OR ACCURACY OF DIMENSIONS.

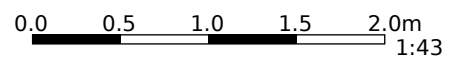

FLOORS: 1

▼ **Hall**
Ground Floor

WIDTH: 1.26 m • **LENGTH:** 1.73 m
AREA: 2.18 m² • **PERIMETER:** 5.98 m

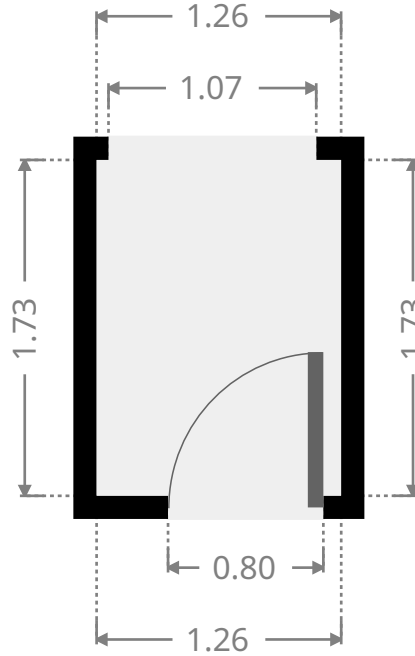
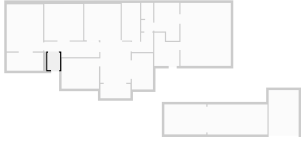

▼ **Other**
Ground Floor

WIDTH: 3.00 m • **LENGTH:** 1.43 m
AREA: 4.29 m² • **PERIMETER:** 8.86 m

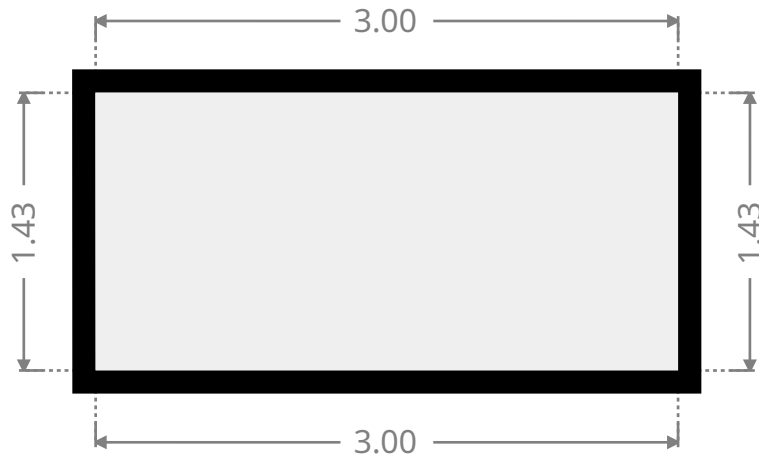
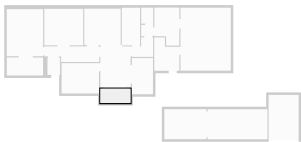

FLOORS: 1

▼ **Kitchen**
Ground Floor

WIDTH: 2.11 m • LENGTH: 3.62 m
AREA: 7.64 m² • PERIMETER: 11.46 m

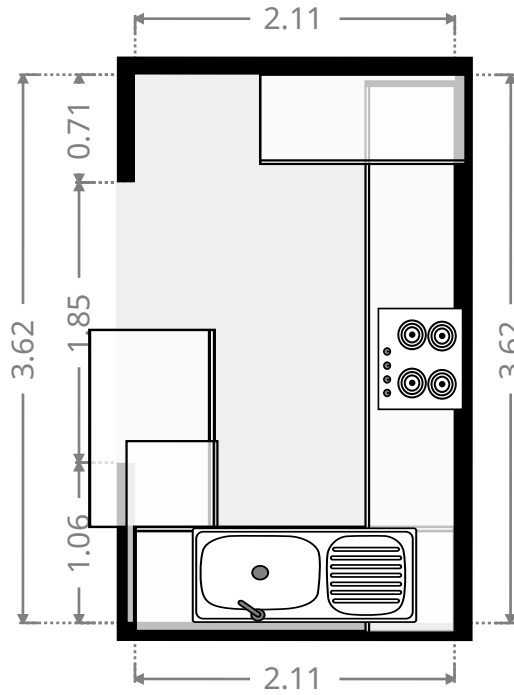
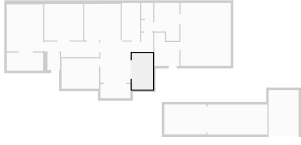

▼ **Bedroom**
Ground Floor

WIDTH: 3.74 m • LENGTH: 3.03 m
AREA: 11.34 m² • PERIMETER: 13.54 m

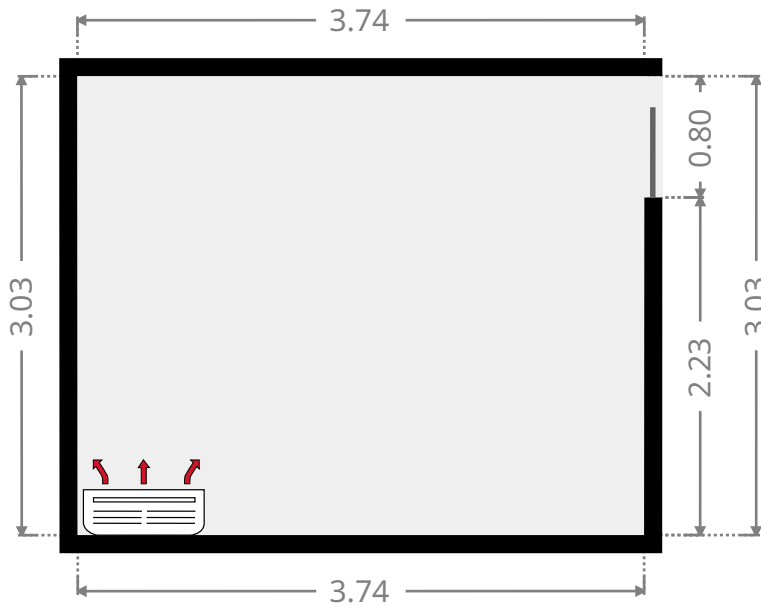
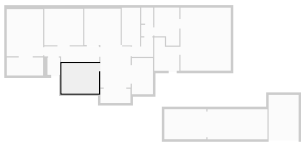

FLOORS: 1

▼ **Dining Room**
Ground Floor

WIDTH: 3.03 m • LENGTH: 4.12 m
AREA: 12.48 m² • PERIMETER: 14.30 m

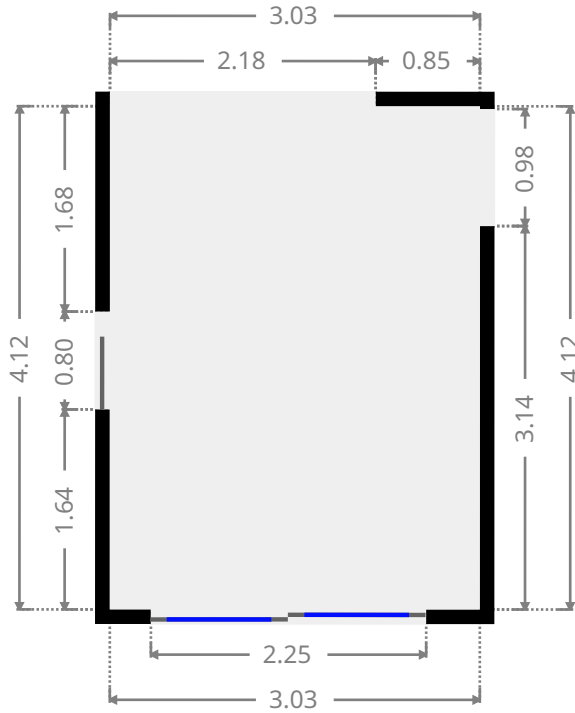
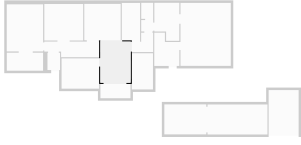

▼ **Living Room**
Ground Floor

WIDTH: 3.64 m • LENGTH: 3.64 m
AREA: 13.25 m² • PERIMETER: 14.56 m

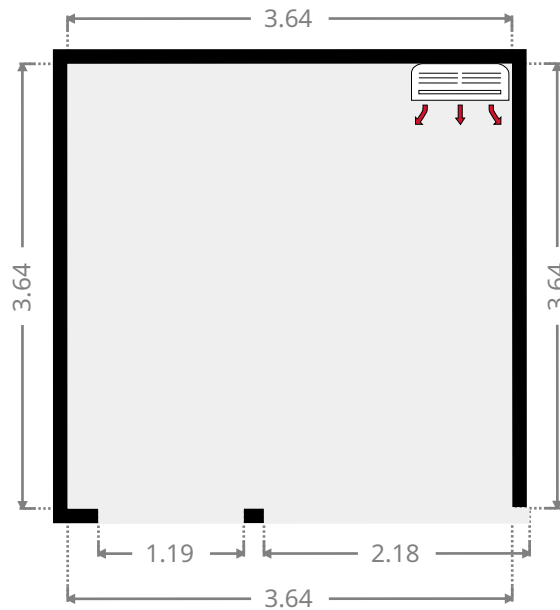
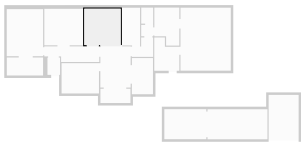

FLOORS: 1

▼ **Bedroom**
Ground Floor

WIDTH: 3.89 m • LENGTH: 3.65 m
AREA: 14.19 m² • PERIMETER: 15.08 m

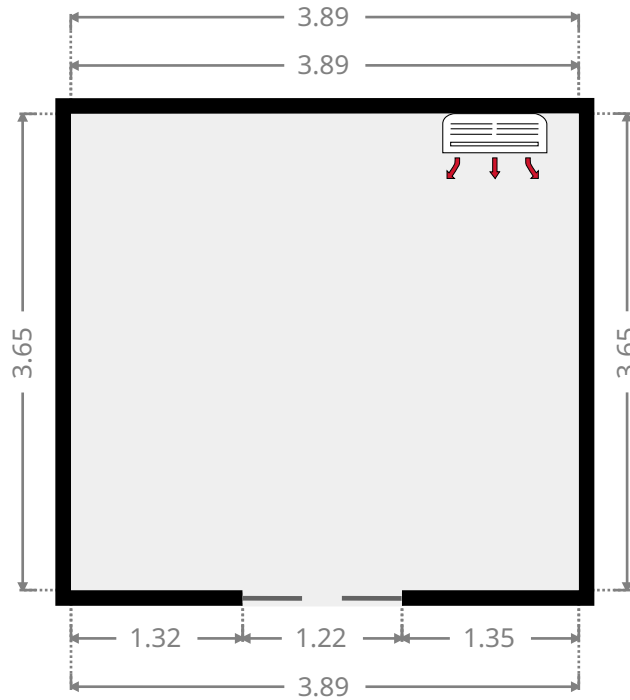
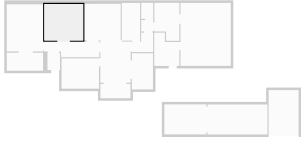

▼ **Closet**
Ground Floor

WIDTH: 3.63 m • LENGTH: 1.80 m
AREA: 6.53 m² • PERIMETER: 10.86 m

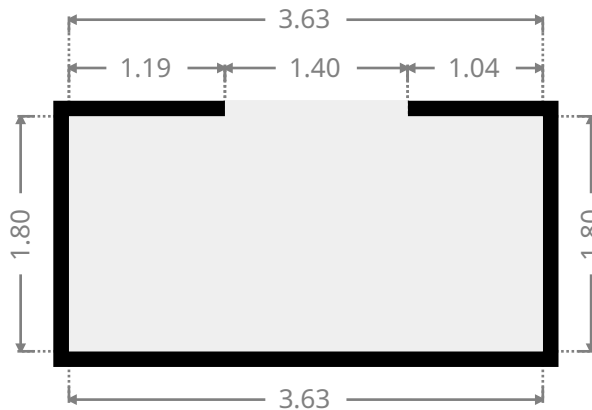
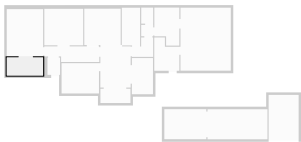

FLOORS: 1

▼ **Master Bedroom**
Ground Floor

WIDTH: 3.64 m • LENGTH: 4.71 m
AREA: 17.15 m² • PERIMETER: 16.70 m

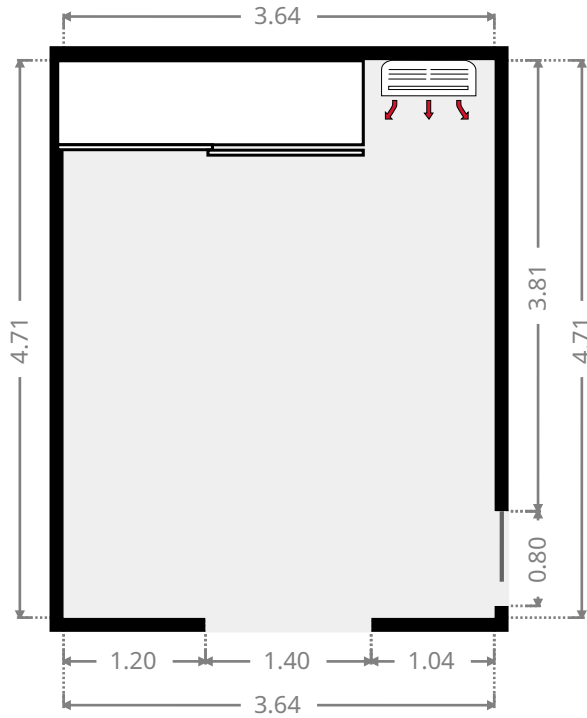
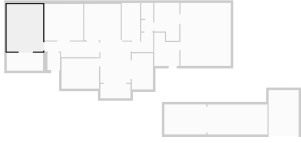

▼ **Hall**
Ground Floor

WIDTH: 5.50 m • LENGTH: 1.56 m
AREA: 7.64 m² • PERIMETER: 14.12 m

