

# 144 Stack Street

## Ground Floor

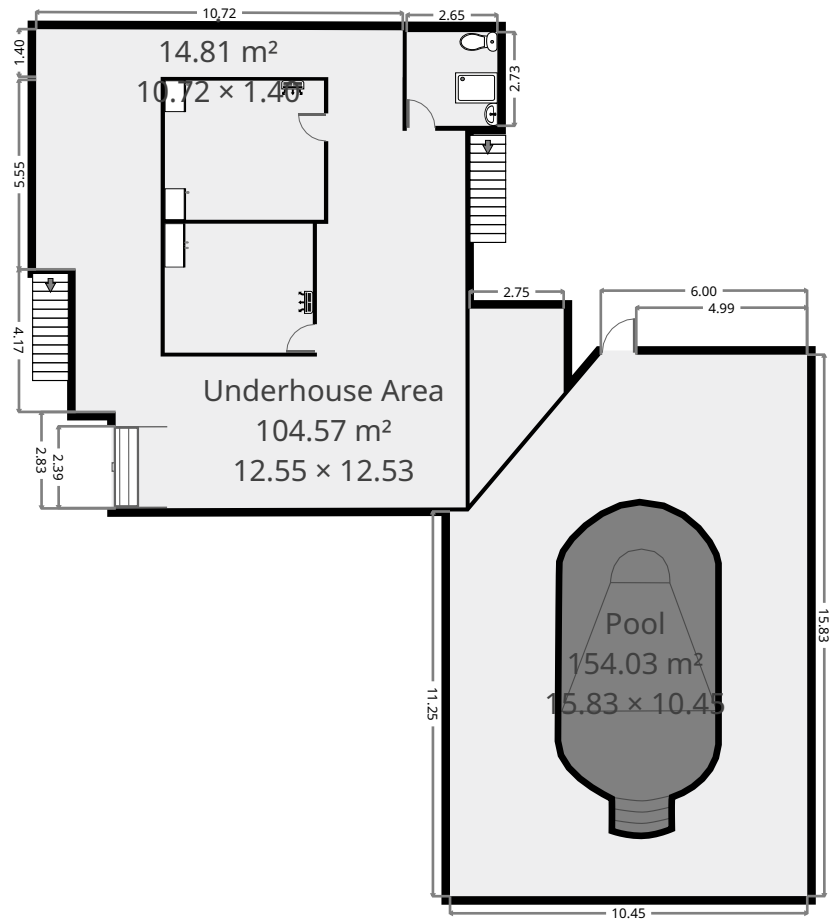

THIS FLOORPLAN IS PROVIDED WITHOUT WARRANTY OF ANY KIND. SENSOPIA DISCLAIMS ANY WARRANTY INCLUDING, WITHOUT LIMITATION, SATISFACTORY QUALITY OR ACCURACY OF DIMENSIONS.

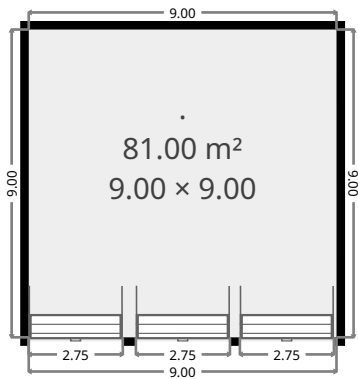
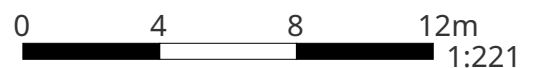

# 144 Stack Street

## Downstairs Rooms

Width: 4.07 m  
 Length: 4.65 m  
 Area: 18.92 m<sup>2</sup>  
 Perimeter: 17.44 m

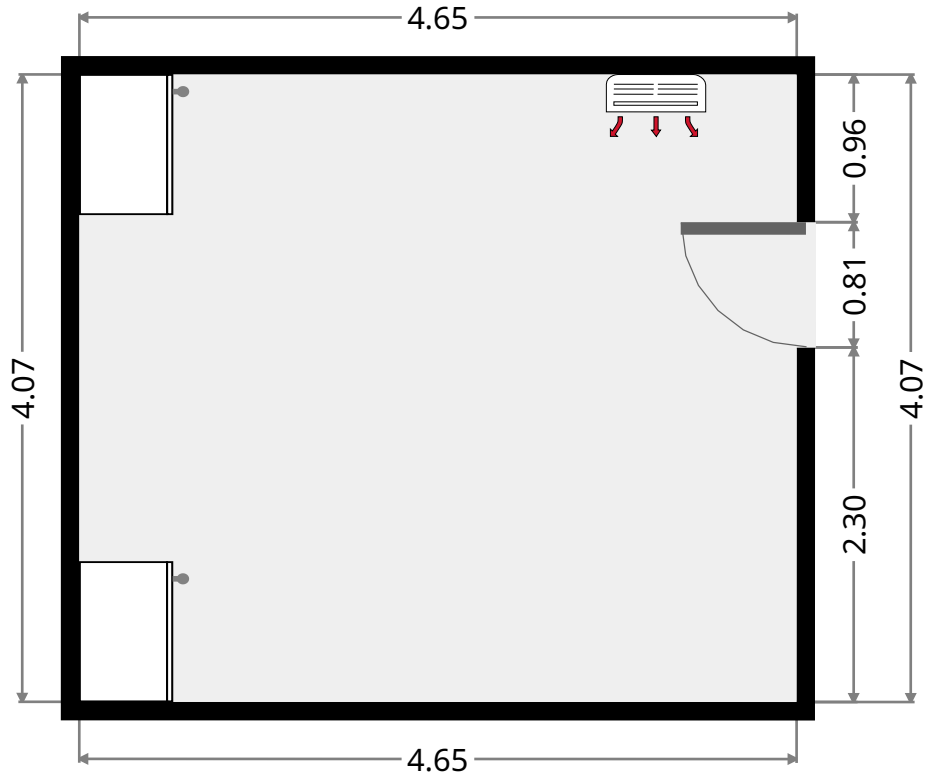
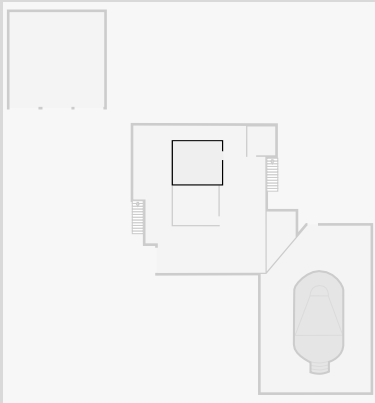

## Downstairs Room

Width: 3.77 m  
 Length: 4.33 m  
 Area: 16.33 m<sup>2</sup>  
 Perimeter: 16.20 m

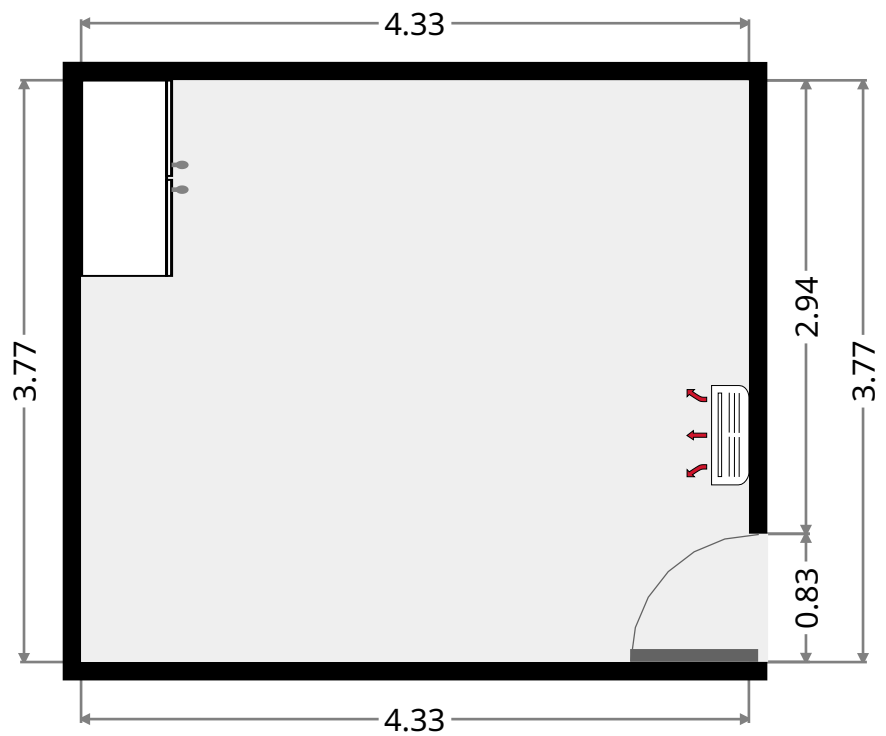
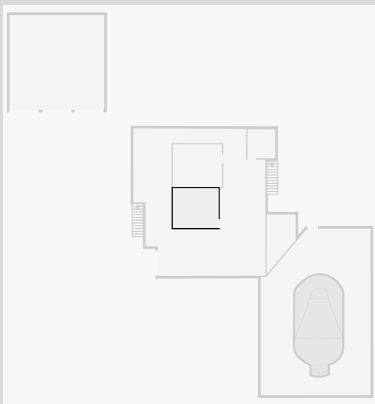

THIS FLOORPLAN IS PROVIDED WITHOUT WARRANTY OF ANY KIND. SENSOPIA DISCLAIMS ANY WARRANTY INCLUDING, WITHOUT LIMITATION, SATISFACTORY QUALITY OR ACCURACY OF DIMENSIONS.

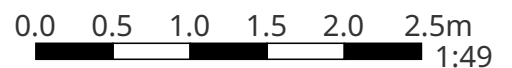

# 144 Stack Street

## Underhouse Area

Width: 12.53 m  
 Length: 12.55 m  
 Area: 104.57 m<sup>2</sup>  
 Perimeter: 66.24 m

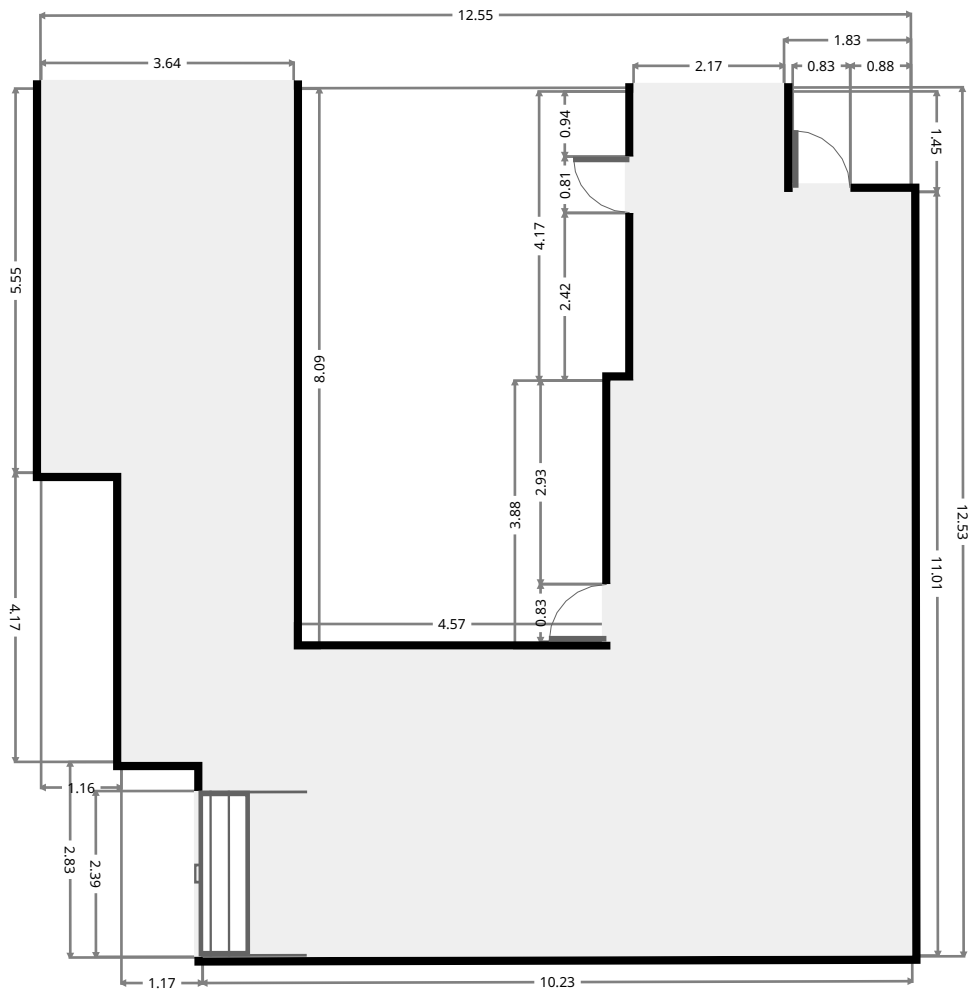
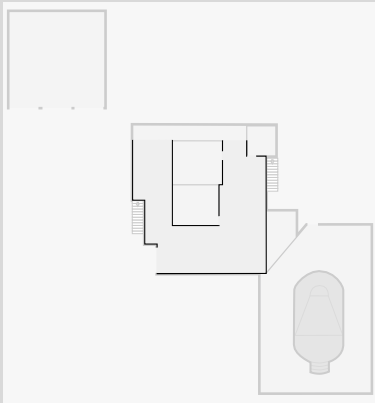

THIS FLOORPLAN IS PROVIDED WITHOUT WARRANTY OF ANY KIND. SENSOPIA DISCLAIMS ANY WARRANTY INCLUDING, WITHOUT LIMITATION, SATISFACTORY QUALITY OR ACCURACY OF DIMENSIONS.

# 144 Stack Street

•  
Width: 1.40 m  
Length: 10.72 m  
Area: 14.81 m<sup>2</sup>  
Perimeter: 24.20 m

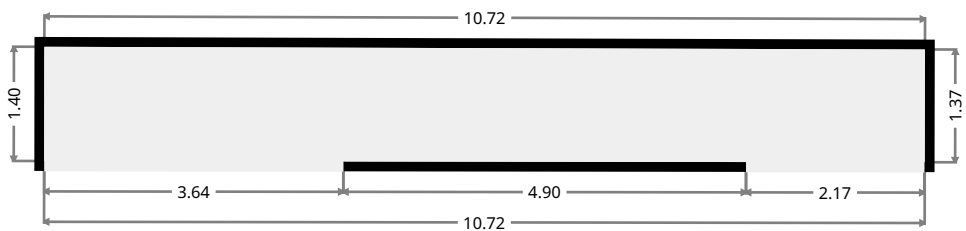
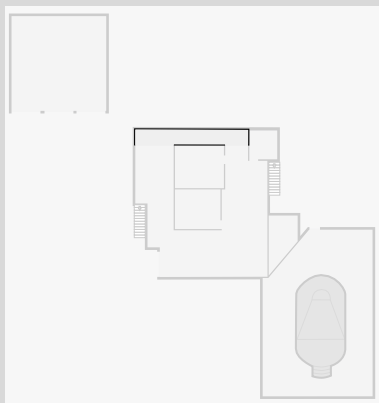

THIS FLOORPLAN IS PROVIDED WITHOUT WARRANTY OF ANY KIND. SENSOPIA DISCLAIMS ANY WARRANTY INCLUDING, WITHOUT LIMITATION, SATISFACTORY QUALITY OR ACCURACY OF DIMENSIONS.



# 144 Stack Street

## Bathroom

Width: 2.65 m  
Length: 2.73 m  
Area: 7.26 m<sup>2</sup>  
Perimeter: 10.78 m

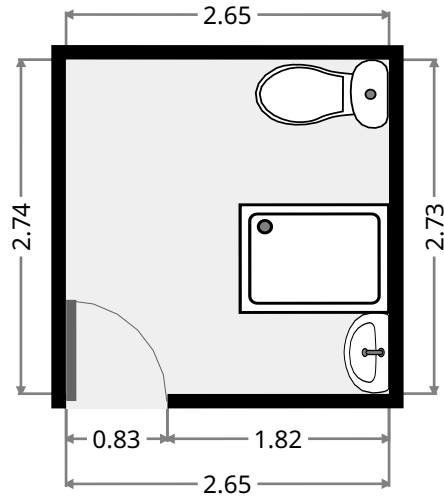
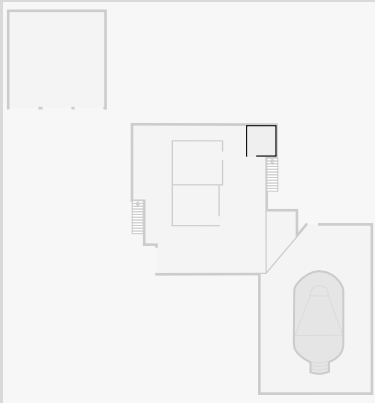

## UnderCover Area

Width: 2.75 m  
Length: 5.70 m  
Area: 11.20 m<sup>2</sup>  
Perimeter: 15.16 m

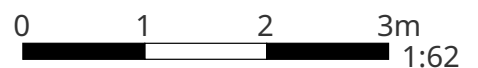
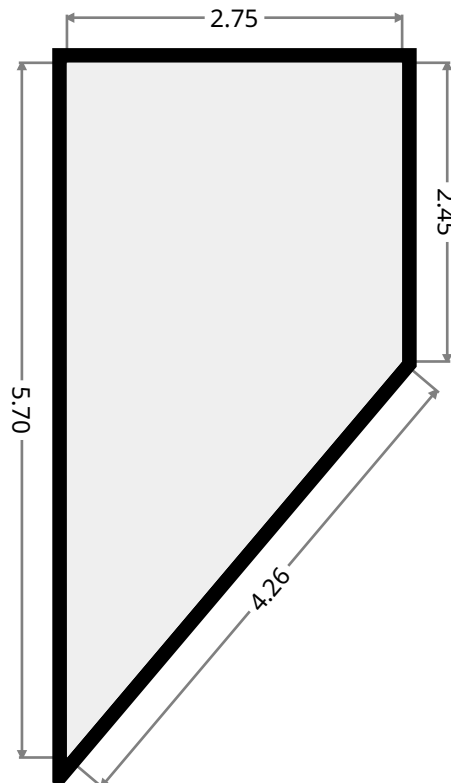
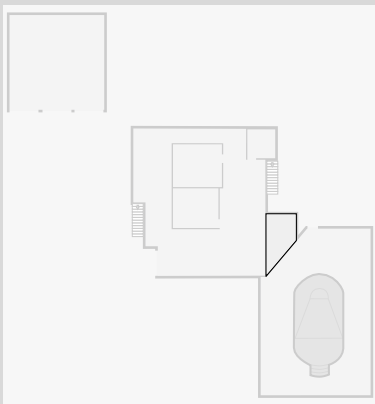

# 144 Stack Street

## Pool

Width: 10.45 m  
Length: 15.83 m  
Area: 154.03 m<sup>2</sup>  
Perimeter: 50.10 m

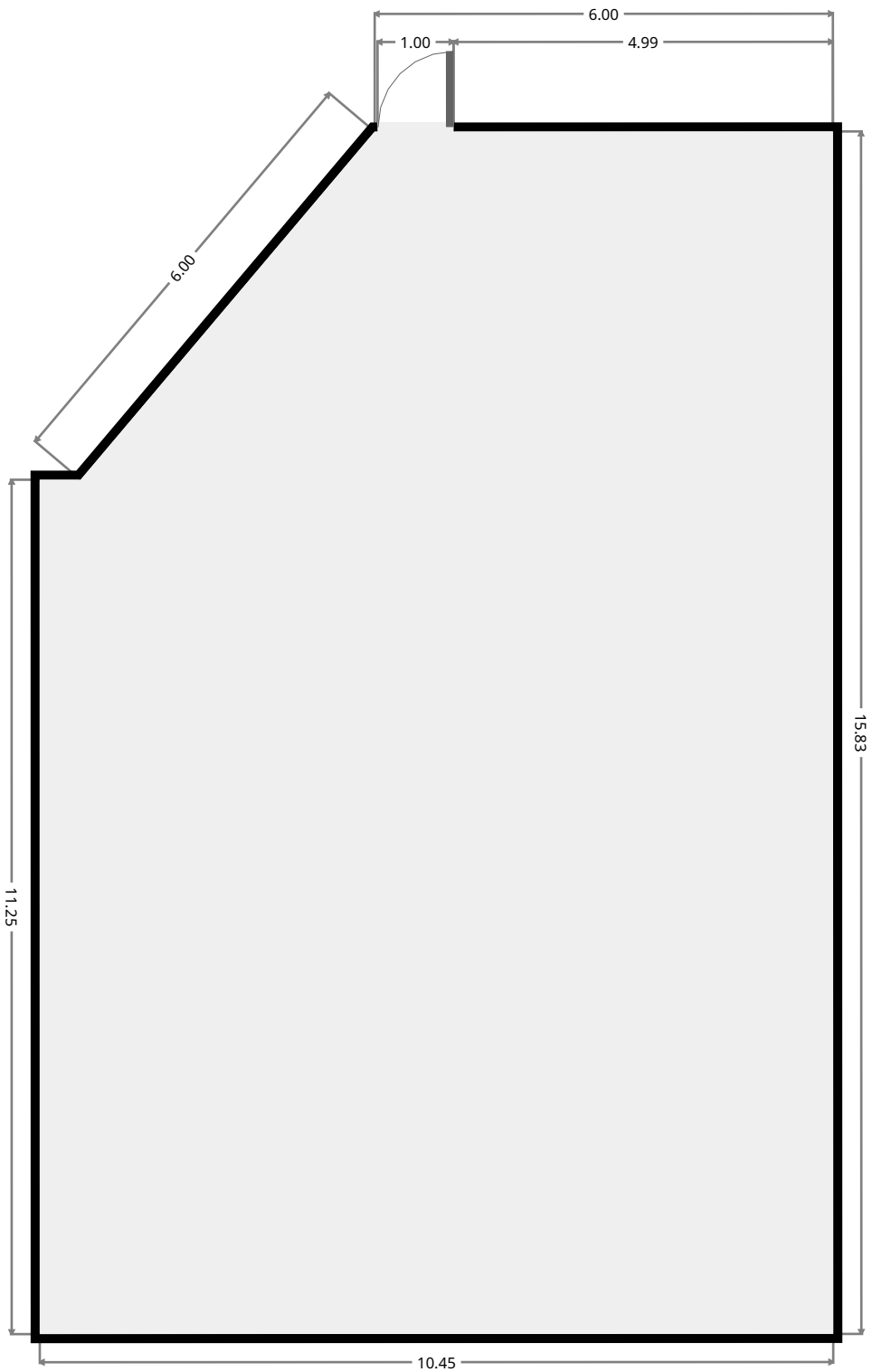
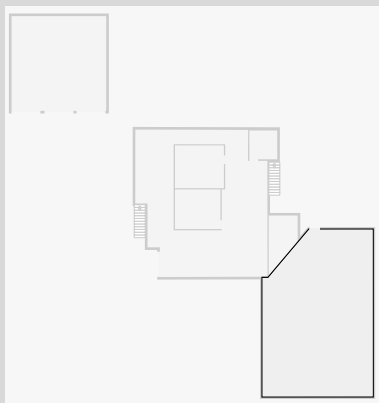

THIS FLOORPLAN IS PROVIDED WITHOUT WARRANTY OF ANY KIND. SENSOPIA DISCLAIMS ANY WARRANTY INCLUDING, WITHOUT LIMITATION, SATISFACTORY QUALITY OR ACCURACY OF DIMENSIONS.



# 144 Stack Street

•  
Width: 9.00 m  
Length: 9.00 m  
Area: 81.00 m<sup>2</sup>  
Perimeter: 36.00 m

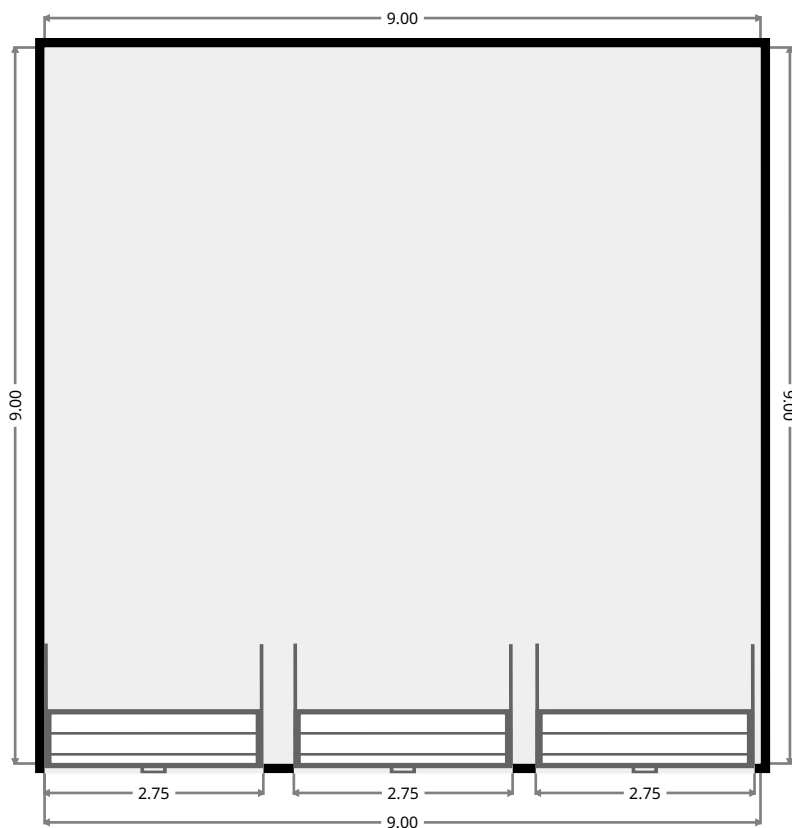
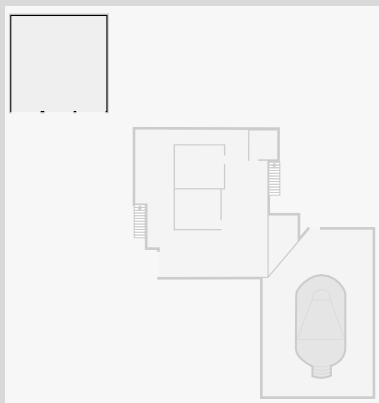

# 144 Stack Street

## 1st Floor



THIS FLOORPLAN IS PROVIDED WITHOUT WARRANTY OF ANY KIND. SENSOPIA DISCLAIMS ANY WARRANTY INCLUDING, WITHOUT LIMITATION, SATISFACTORY QUALITY OR ACCURACY OF DIMENSIONS.

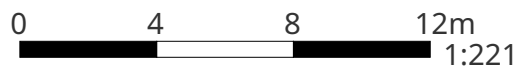



# 144 Stack Street

## Living Room

Width: 3.63 m  
 Length: 5.51 m  
 Area: 19.97 m<sup>2</sup>  
 Perimeter: 18.27 m

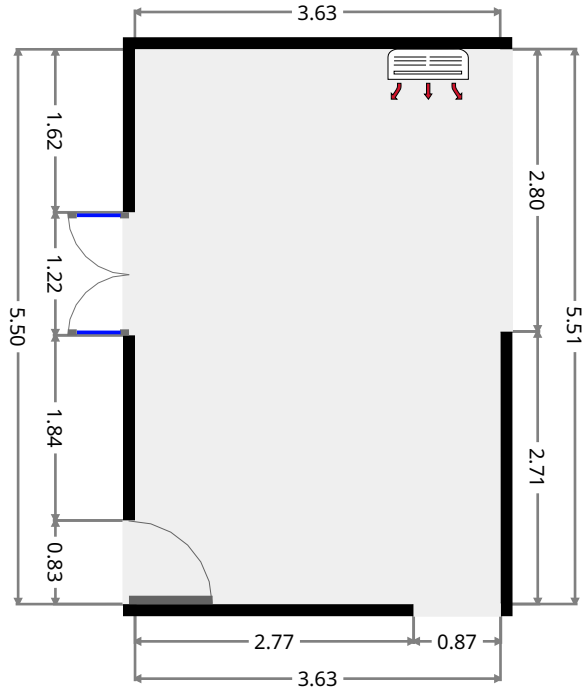
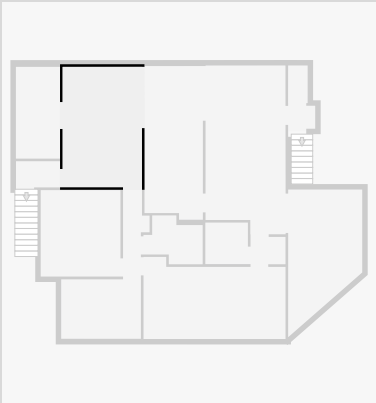

## Kitchen/Dining

Width: 2.67 m  
 Length: 7.03 m  
 Area: 18.31 m<sup>2</sup>  
 Perimeter: 19.41 m

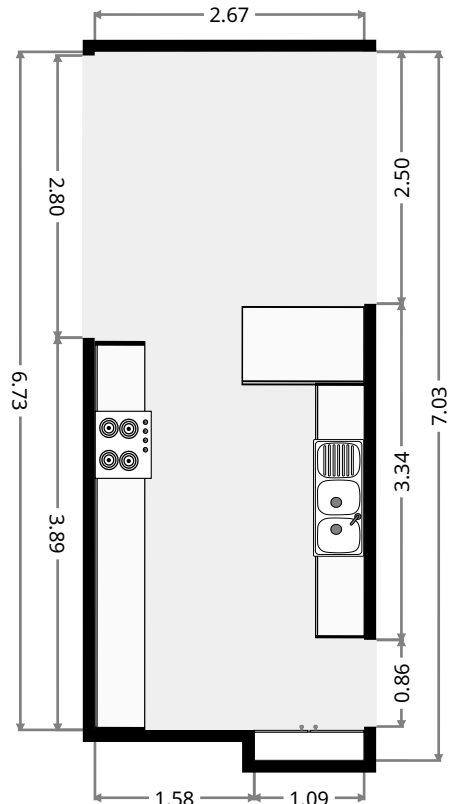
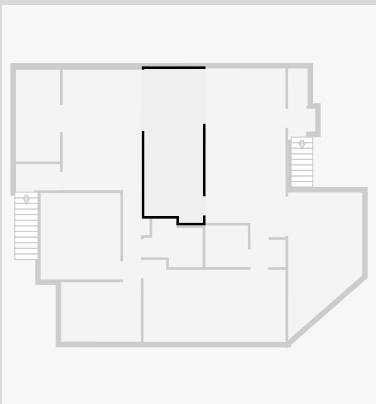

THIS FLOORPLAN IS PROVIDED WITHOUT WARRANTY OF ANY KIND. SENSOPIA DISCLAIMS ANY WARRANTY INCLUDING, WITHOUT LIMITATION, SATISFACTORY QUALITY OR ACCURACY OF DIMENSIONS.

# 144 Stack Street

## Dining Room

Width: 3.65 m  
 Length: 7.73 m  
 Area: 26.95 m<sup>2</sup>  
 Perimeter: 22.77 m

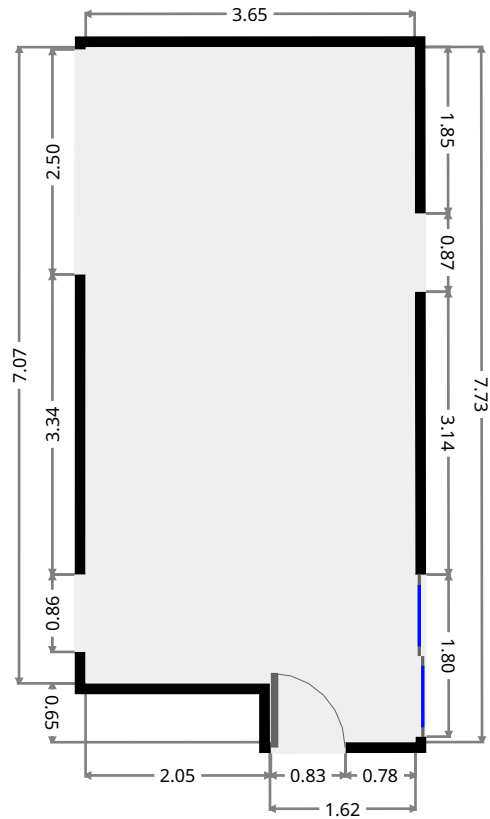
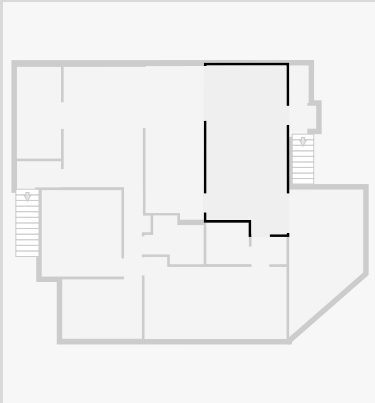

## Hall

Width: 1.25 m  
 Length: 1.60 m  
 Area: 2.00 m<sup>2</sup>  
 Perimeter: 5.70 m

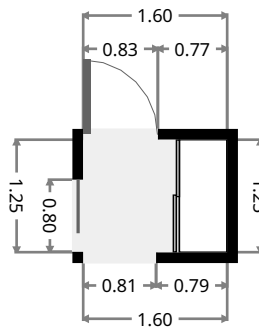
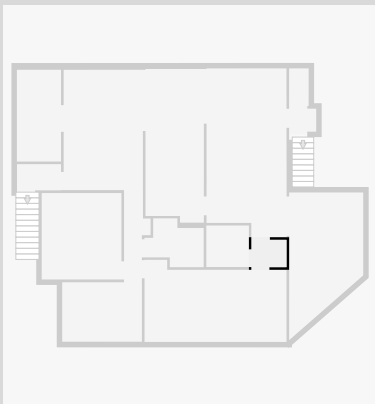

# 144 Stack Street

## Master Bedroom

Width: 3.76 m  
Length: 6.50 m  
Area: 21.94 m<sup>2</sup>  
Perimeter: 20.52 m

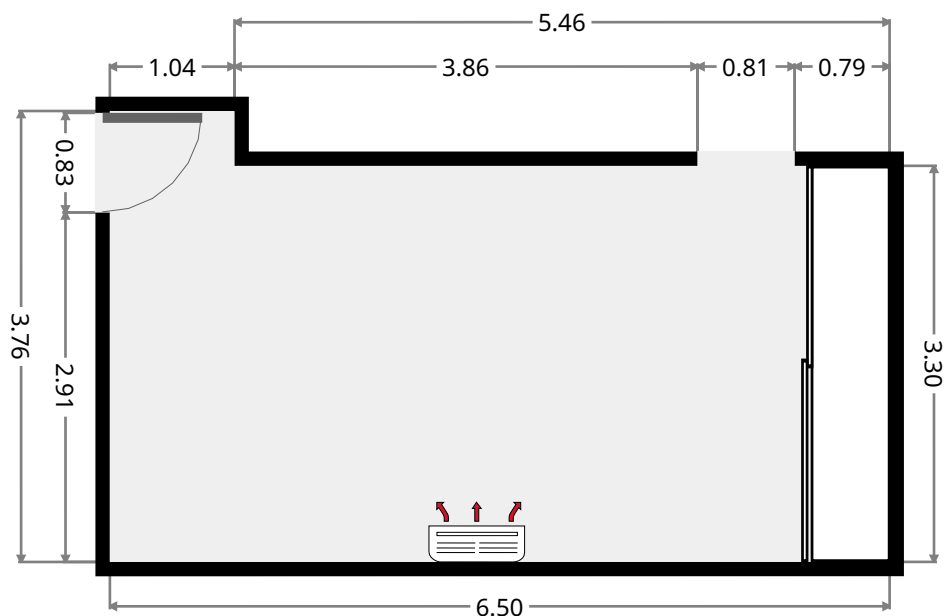
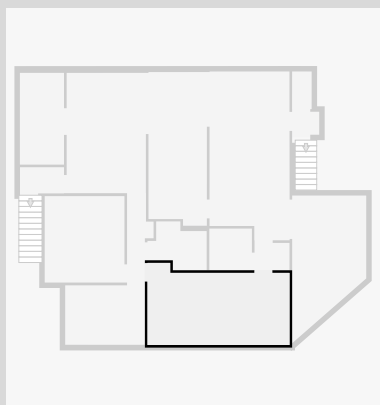

## Ensuite

Width: 1.90 m  
Length: 1.95 m  
Area: 3.70 m<sup>2</sup>  
Perimeter: 7.70 m

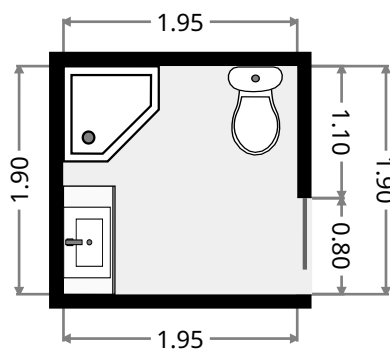
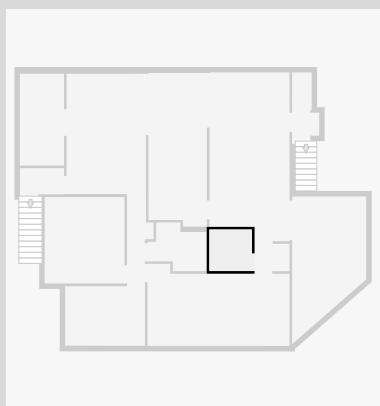

# 144 Stack Street

## Bathroom

Width: 2.24 m  
 Length: 2.71 m  
 Area: 4.65 m<sup>2</sup>  
 Perimeter: 9.89 m

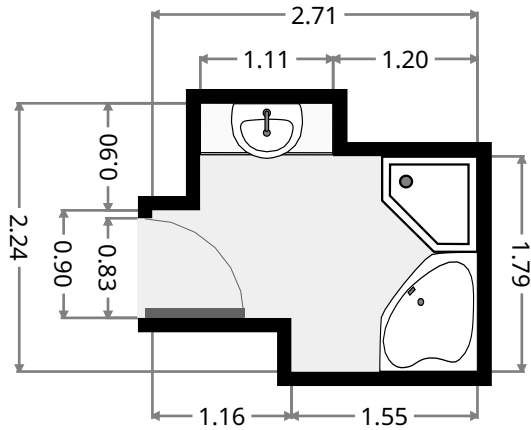
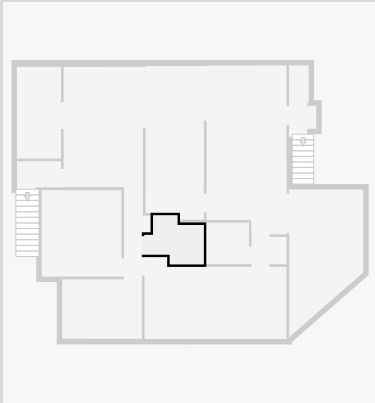

## Hall

Width: 1.21 m  
 Length: 3.97 m  
 Area: 3.60 m<sup>2</sup>  
 Perimeter: 10.38 m

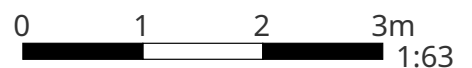
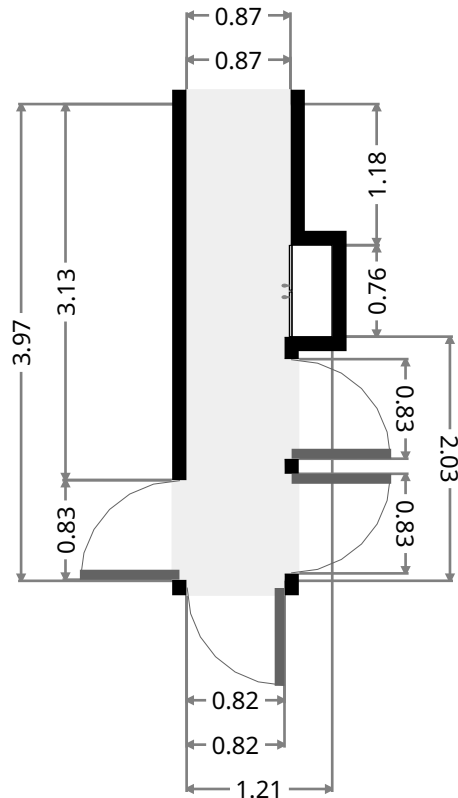
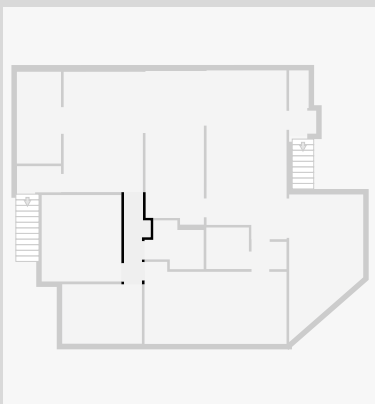

# 144 Stack Street

## Bedroom

Width: 3.65 m  
 Length: 3.95 m  
 Area: 14.43 m<sup>2</sup>  
 Perimeter: 15.21 m

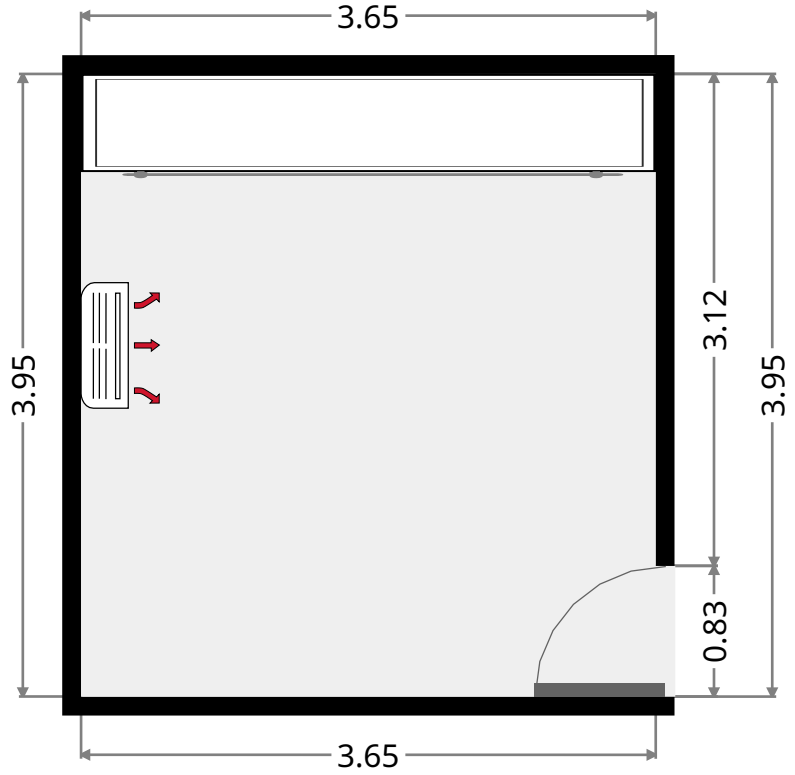
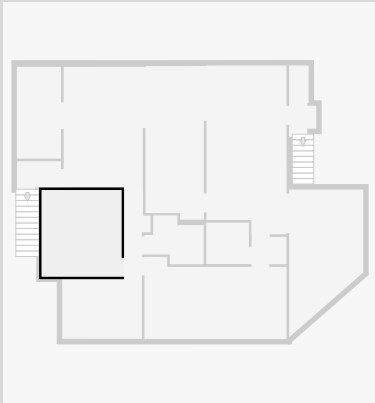

## Bedroom

Width: 2.72 m  
 Length: 3.65 m  
 Area: 9.93 m<sup>2</sup>  
 Perimeter: 12.74 m

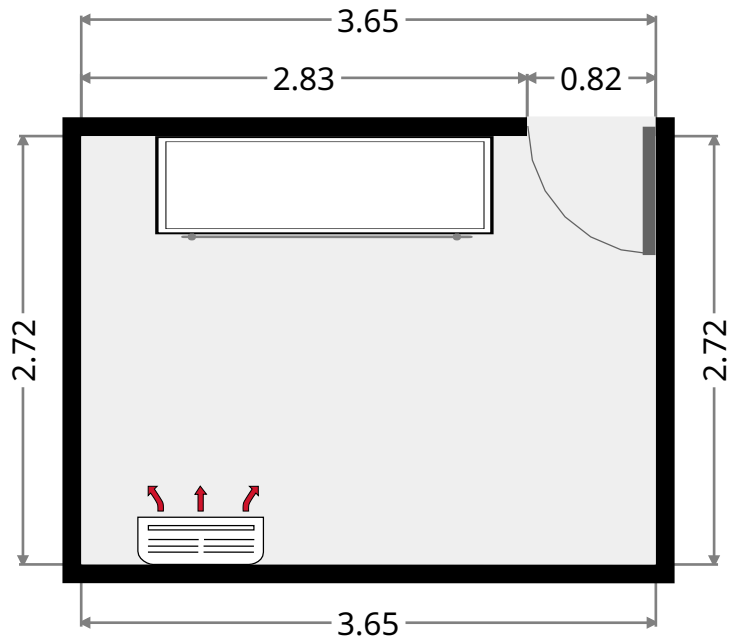
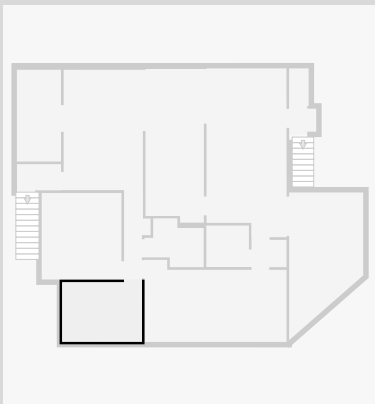

THIS FLOORPLAN IS PROVIDED WITHOUT WARRANTY OF ANY KIND. SENSOPIA DISCLAIMS ANY WARRANTY INCLUDING, WITHOUT LIMITATION, SATISFACTORY QUALITY OR ACCURACY OF DIMENSIONS.

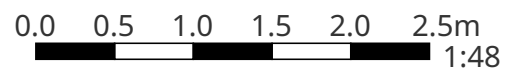

# 144 Stack Street

## Study

Width: 2.02 m  
 Length: 4.20 m  
 Area: 8.48 m<sup>2</sup>  
 Perimeter: 12.44 m

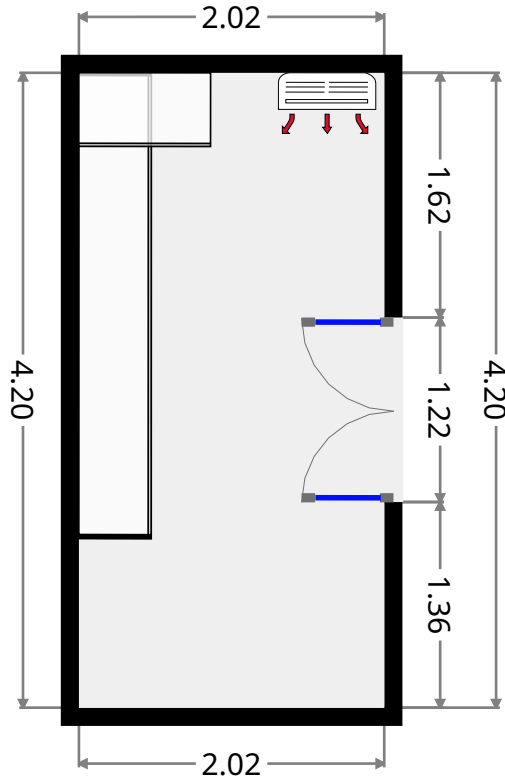
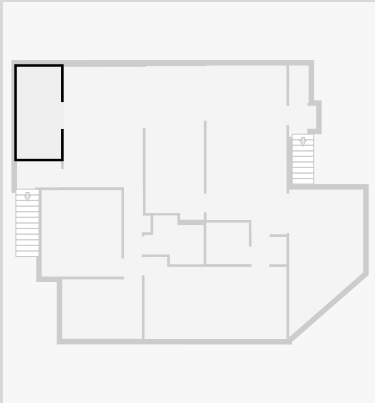

Width: 1.20 m  
 Length: 2.02 m  
 Area: 2.41 m<sup>2</sup>  
 Perimeter: 6.43 m

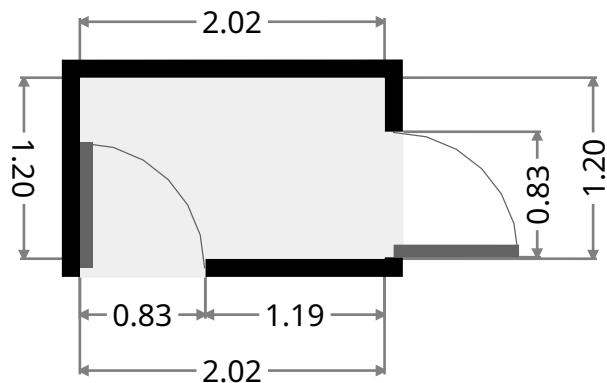
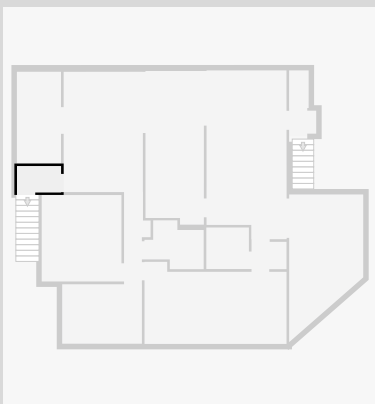

# 144 Stack Street

## Deck

Width: 3.39 m  
 Length: 6.76 m  
 Area: 17.89 m<sup>2</sup>  
 Perimeter: 18.45 m

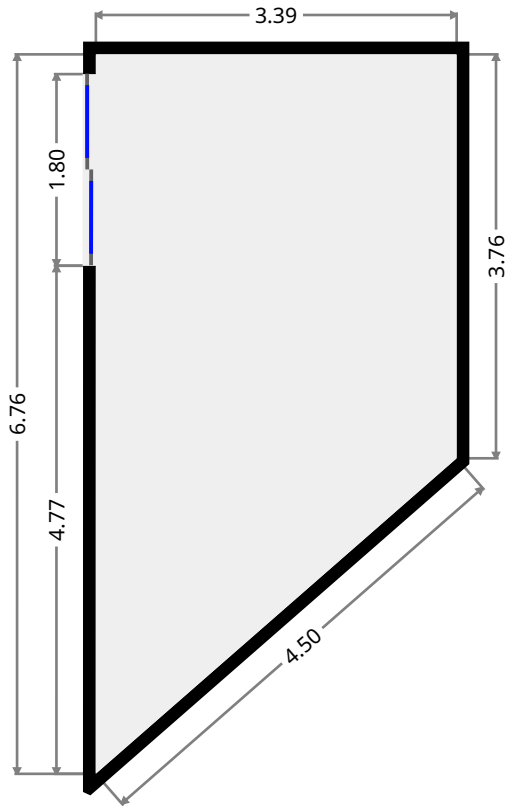
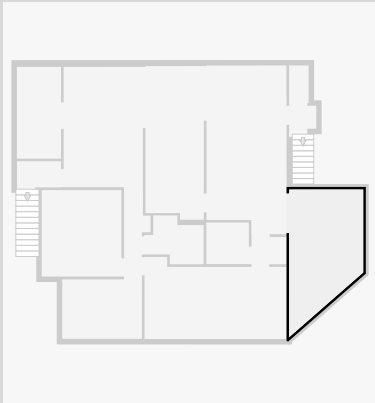

## Hall

Width: 1.05 m  
 Length: 1.24 m  
 Area: 1.30 m<sup>2</sup>  
 Perimeter: 4.58 m

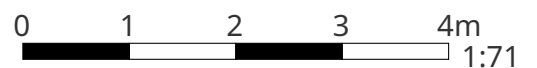
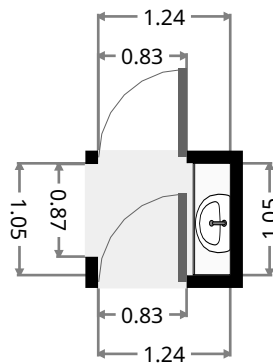
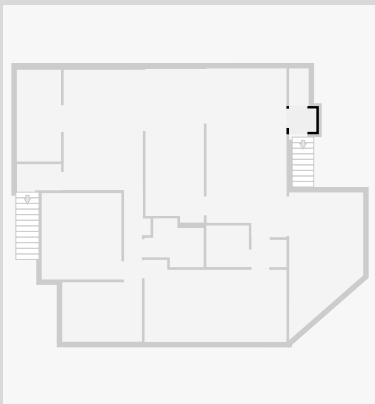

# 144 Stack Street

## Toilet

Width: 0.89 m  
Length: 1.72 m  
Area: 1.54 m<sup>2</sup>  
Perimeter: 5.24 m

