

# 143 Constance Avenue

**SUBMITTED BY**

Ray White Rockhampton Casey  
stockers@cqoz.com

---

**CREATED ON**

2022-03-29

---

**Floors**

1

---

▼ Ground Floor

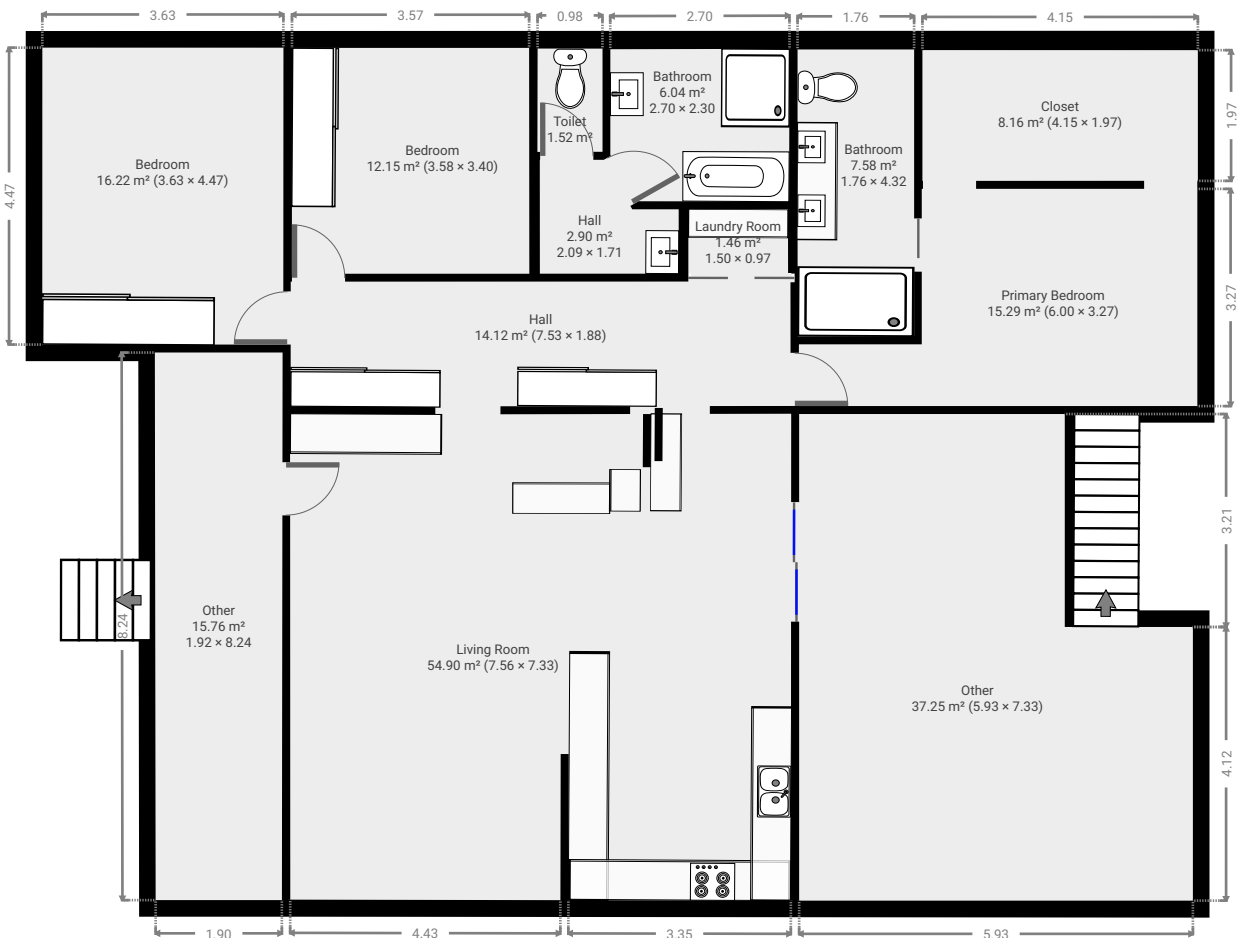

FLOORS: 1

▼ **Living Room**  
Ground Floor

WIDTH: 7.33 m • LENGTH: 7.56 m  
AREA: 54.90 m<sup>2</sup> • PERIMETER: 34.11 m

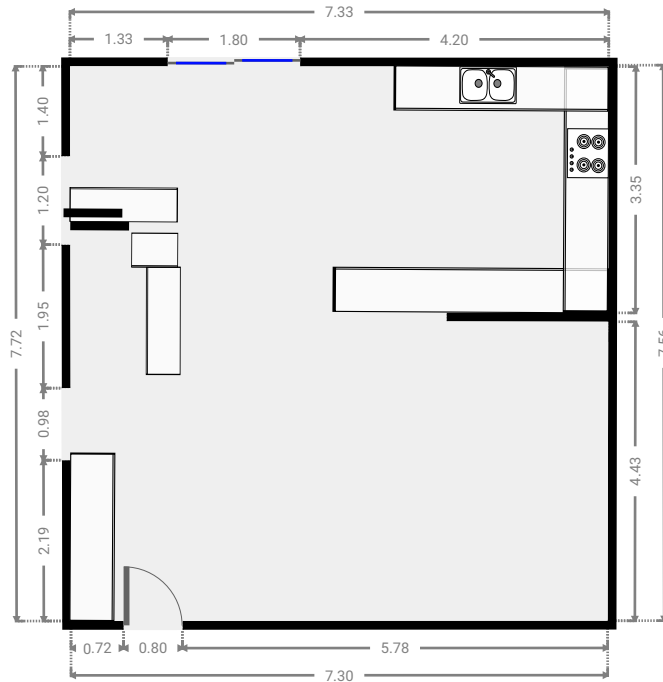

▼ **Hall**  
Ground Floor

WIDTH: 1.88 m • LENGTH: 7.53 m  
AREA: 14.12 m<sup>2</sup> • PERIMETER: 18.80 m

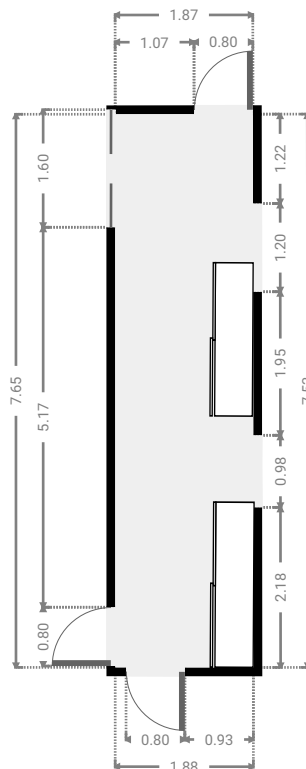

▼ **Laundry Room**  
Ground Floor

WIDTH: 0.97 m • LENGTH: 1.50 m  
AREA: 1.46 m<sup>2</sup> • PERIMETER: 4.94 m

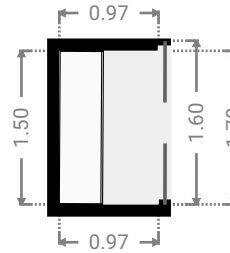

▼ **Primary Bedroom**  
Ground Floor

WIDTH: 3.27 m • LENGTH: 6.00 m  
AREA: 15.29 m<sup>2</sup> • PERIMETER: 18.54 m

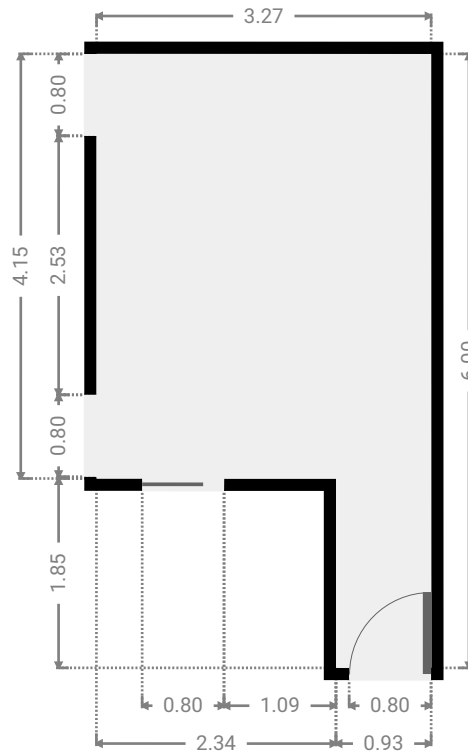

FLOORS: 1

▼ **Bathroom**  
Ground Floor

WIDTH: 4.32 m • LENGTH: 1.76 m  
AREA: 7.58 m<sup>2</sup> • PERIMETER: 12.15 m

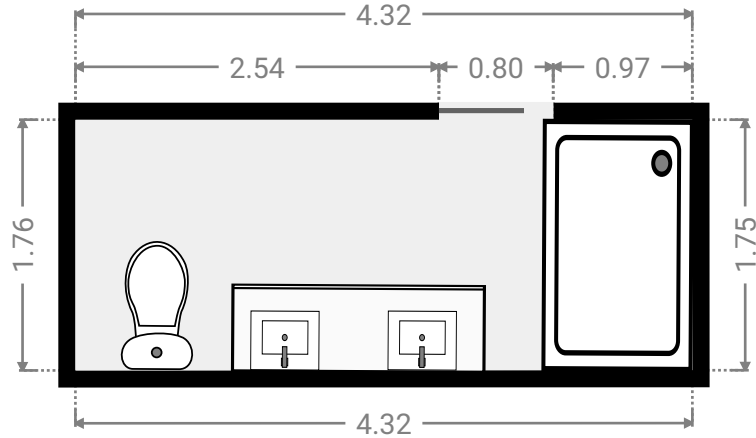

▼ **Closet**  
Ground Floor

WIDTH: 1.97 m • LENGTH: 4.15 m  
AREA: 8.16 m<sup>2</sup> • PERIMETER: 12.23 m

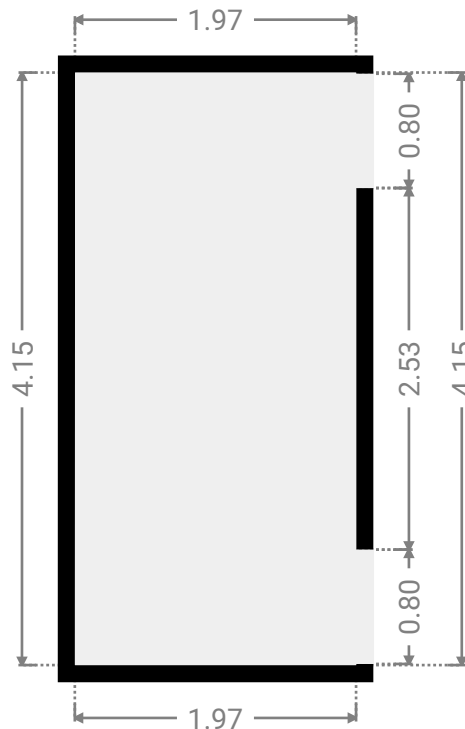

FLOORS: 1

▼ **Bedroom**  
Ground Floor

WIDTH: 4.47 m • LENGTH: 3.63 m  
AREA: 16.22 m<sup>2</sup> • PERIMETER: 16.20 m

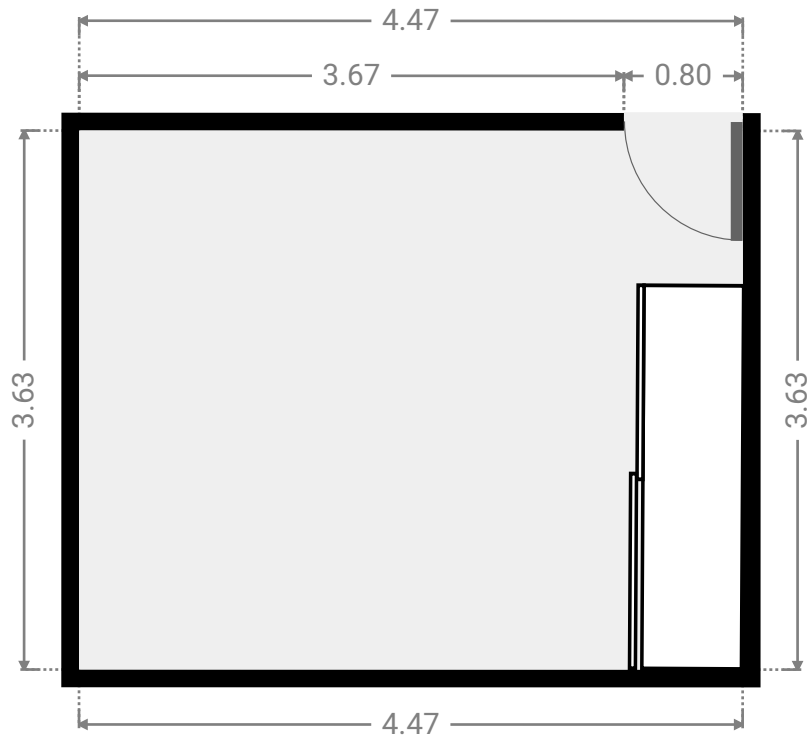

▼ **Bedroom**  
Ground Floor

WIDTH: 3.40 m • LENGTH: 3.58 m  
AREA: 12.15 m<sup>2</sup> • PERIMETER: 13.95 m

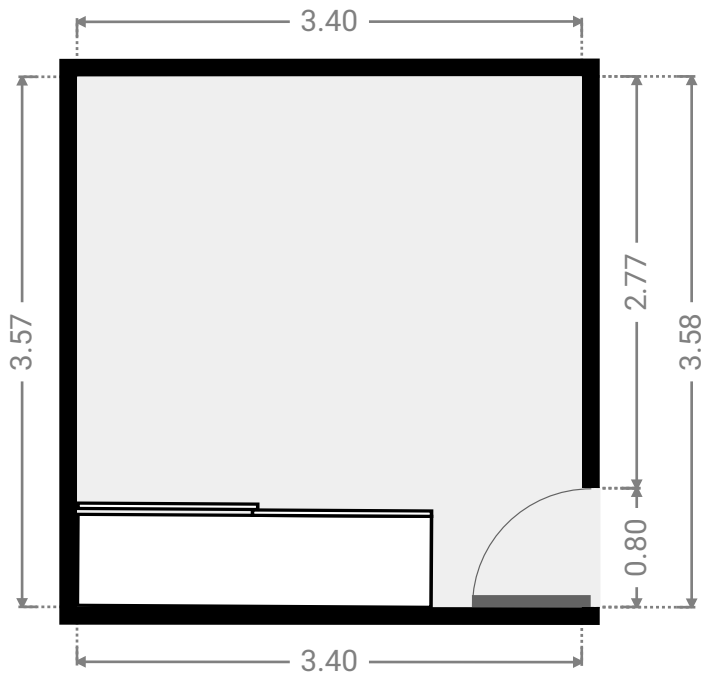

▼ Hall  
Ground Floor

WIDTH: 1.71 m • LENGTH: 2.09 m  
AREA: 2.90 m<sup>2</sup> • PERIMETER: 7.30 m

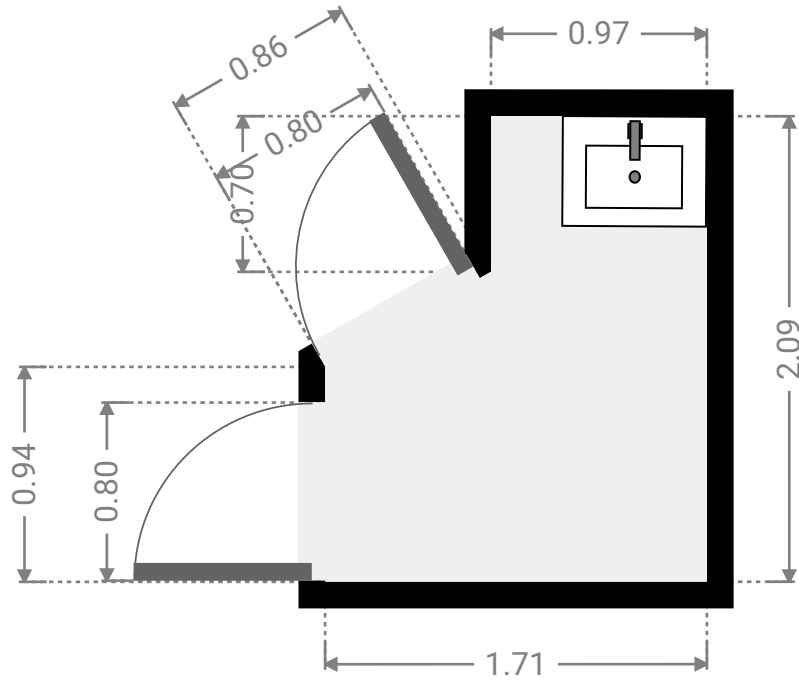

▼ Toilet  
Ground Floor

WIDTH: 1.56 m • LENGTH: 0.98 m  
AREA: 1.52 m<sup>2</sup> • PERIMETER: 5.07 m

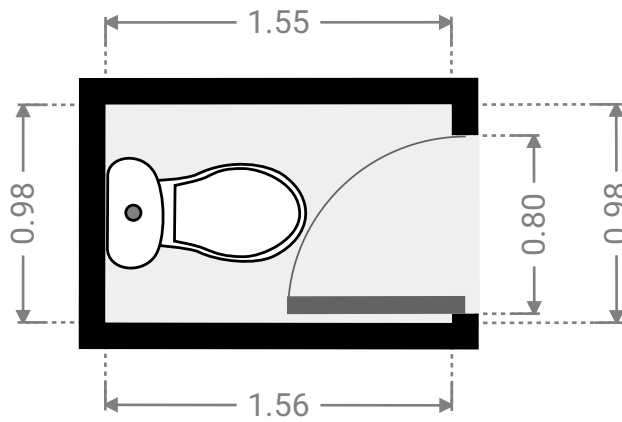

FLOORS: 1

▼ **Bathroom**  
Ground Floor

WIDTH: 2.30 m • LENGTH: 2.70 m  
AREA: 6.04 m<sup>2</sup> • PERIMETER: 9.68 m

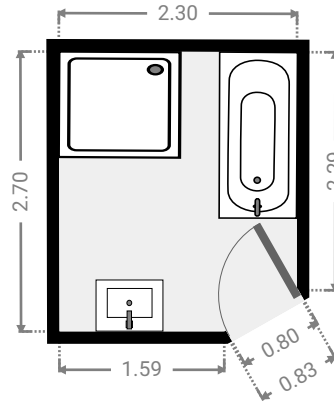

▼ **Other**  
Ground Floor

WIDTH: 7.33 m • LENGTH: 5.93 m  
AREA: 37.25 m<sup>2</sup> • PERIMETER: 26.51 m

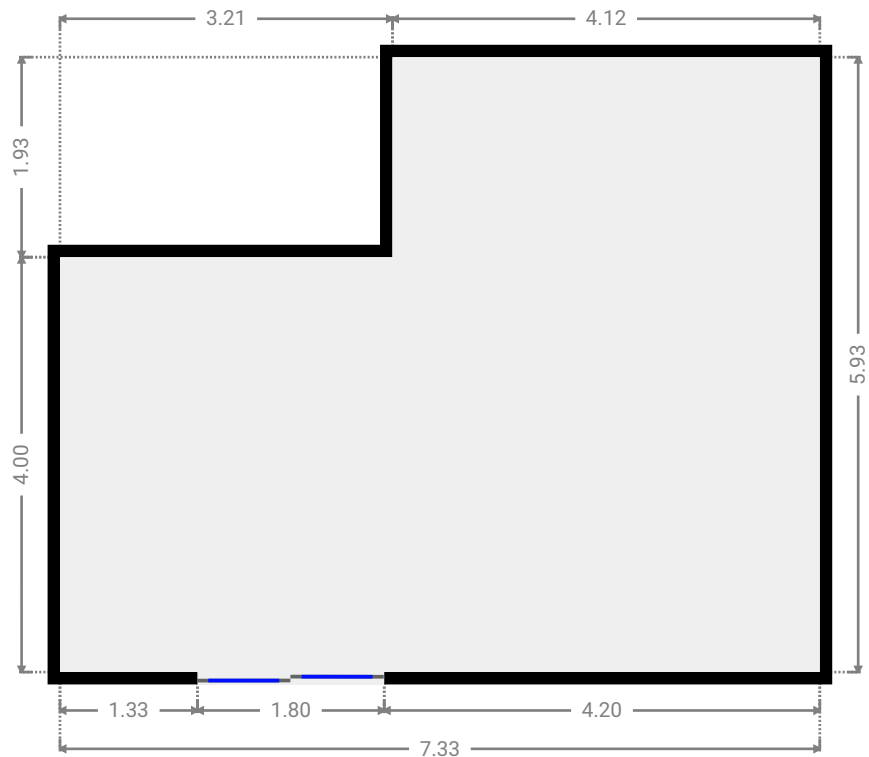



▼ Other  
Ground Floor

WIDTH: 8.24 m • LENGTH: 1.92 m  
AREA: 15.76 m<sup>2</sup> • PERIMETER: 20.31 m

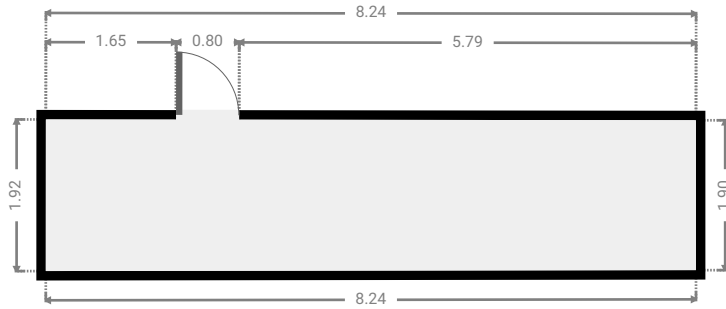

▼ Other  
Ground Floor

WIDTH: 10.00 m • LENGTH: 7.00 m  
AREA: 70.00 m<sup>2</sup> • PERIMETER: 34.00 m

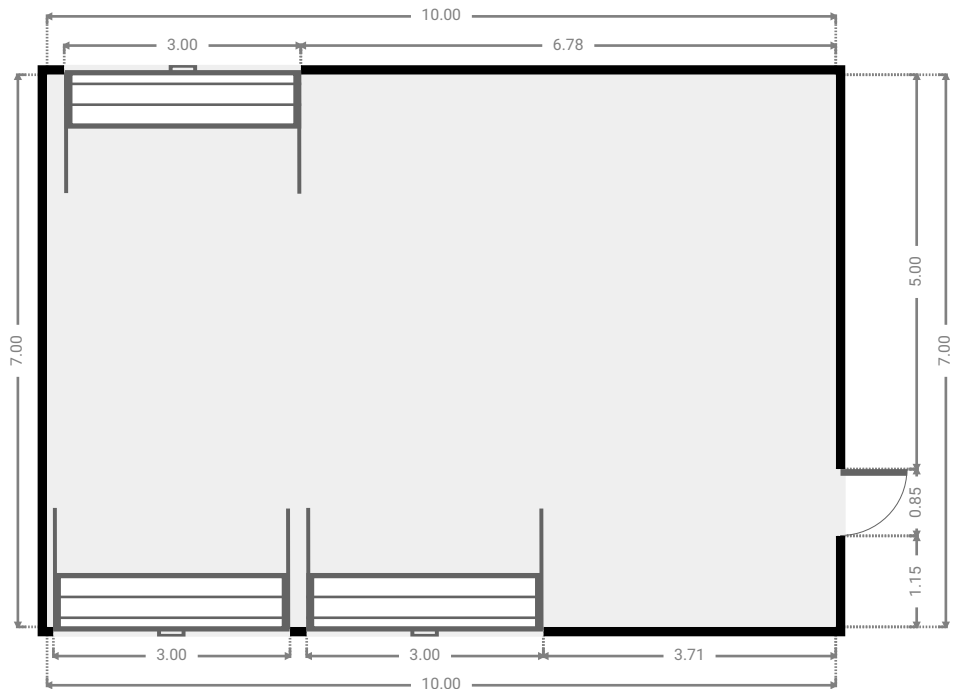
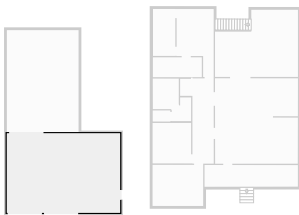

FLOORS: 1

▼ Other  
Ground Floor

WIDTH: 6.33 m • LENGTH: 9.00 m  
AREA: 56.97 m<sup>2</sup> • PERIMETER: 30.66 m

