

# 140-144 Angela Road

## Ground Floor

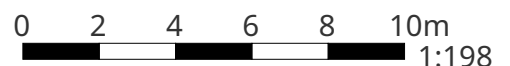

THIS FLOORPLAN IS PROVIDED WITHOUT WARRANTY OF ANY KIND. SENSOPIA DISCLAIMS ANY WARRANTY INCLUDING, WITHOUT LIMITATION, SATISFACTORY QUALITY OR ACCURACY OF DIMENSIONS.



# 140-144 Angela Road

## Bedroom

Width: 3.23 m  
Length: 3.77 m  
Area: 12.19 m<sup>2</sup>  
Perimeter: 14.01 m

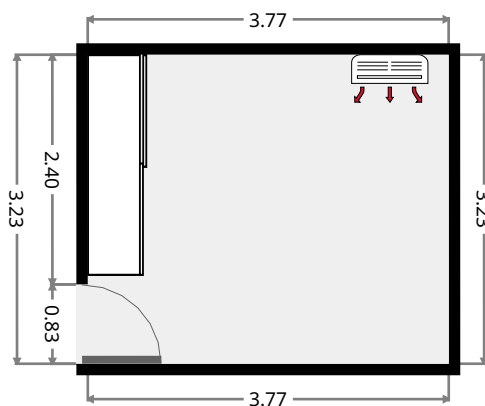
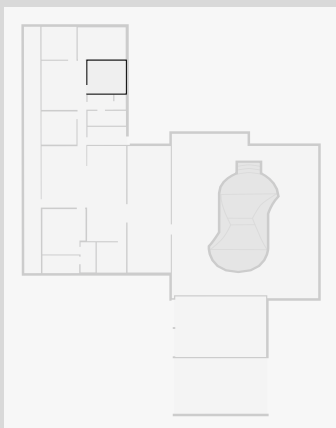

## Awning

Width: 5.50 m  
Length: 9.00 m  
Area: 49.49 m<sup>2</sup>  
Perimeter: 29.00 m

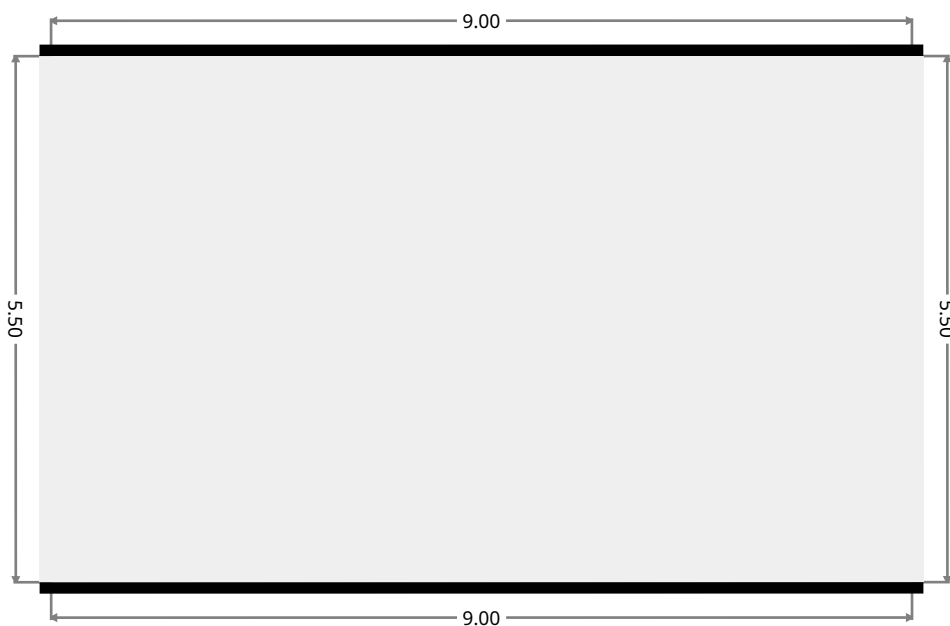
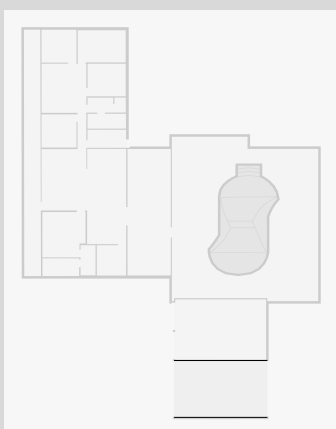

# 140-144 Angela Road

## Shed

Width: 6.00 m  
Length: 9.00 m  
Area: 53.98 m<sup>2</sup>  
Perimeter: 30.00 m

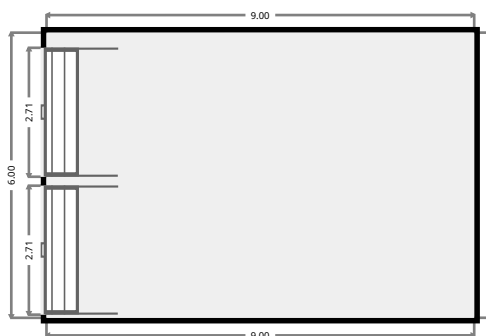
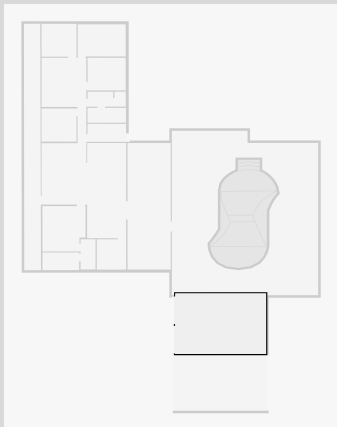

## Pool Area

Width: 14.50 m  
Length: 16.29 m  
Area: 225.01 m<sup>2</sup>  
Perimeter: 62.16 m

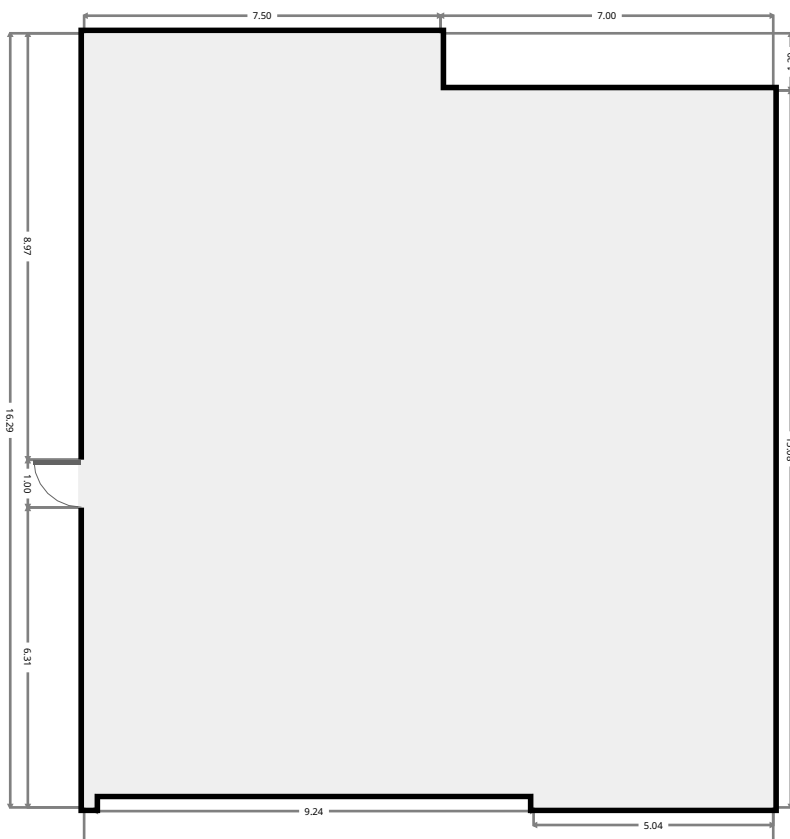
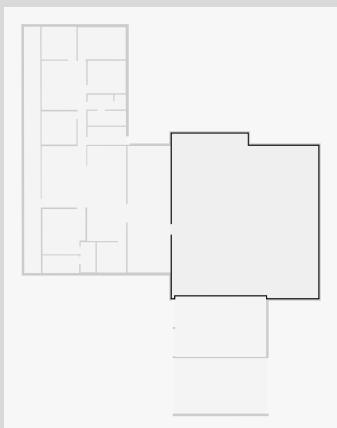

THIS FLOORPLAN IS PROVIDED WITHOUT WARRANTY OF ANY KIND. SENSOPIA DISCLAIMS ANY WARRANTY INCLUDING, WITHOUT LIMITATION, SATISFACTORY QUALITY OR ACCURACY OF DIMENSIONS.

# 140-144 Angela Road

## Front Patio

Width: 1.66 m  
Length: 24.41 m  
Area: 39.98 m<sup>2</sup>  
Perimeter: 52.10 m

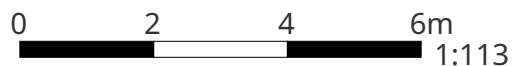
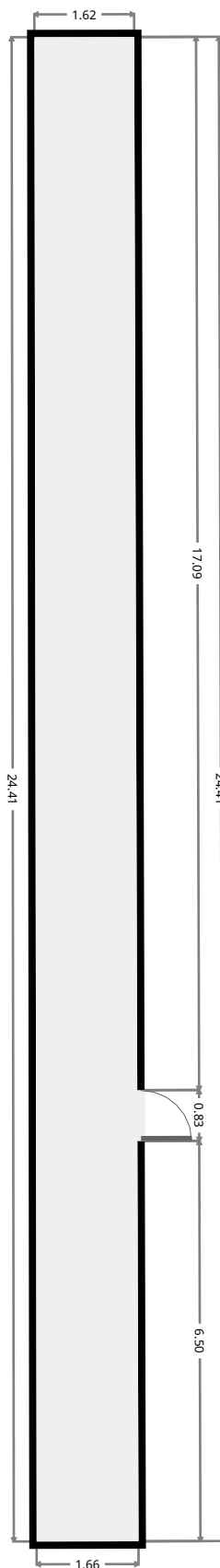
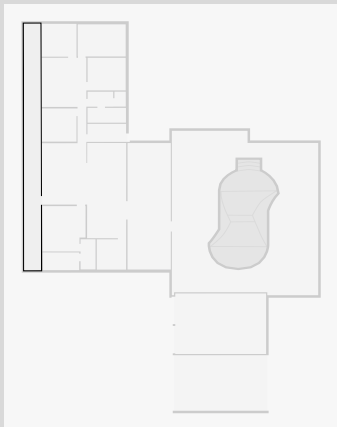

THIS FLOORPLAN IS PROVIDED WITHOUT WARRANTY OF ANY KIND. SENSOPIA DISCLAIMS ANY WARRANTY INCLUDING, WITHOUT LIMITATION, SATISFACTORY QUALITY OR ACCURACY OF DIMENSIONS.

# 140-144 Angela Road

## Outdoor Entertainment Area

Width: 4.29 m  
Length: 12.53 m  
Area: 53.72 m<sup>2</sup>  
Perimeter: 33.63 m

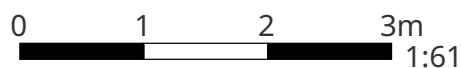
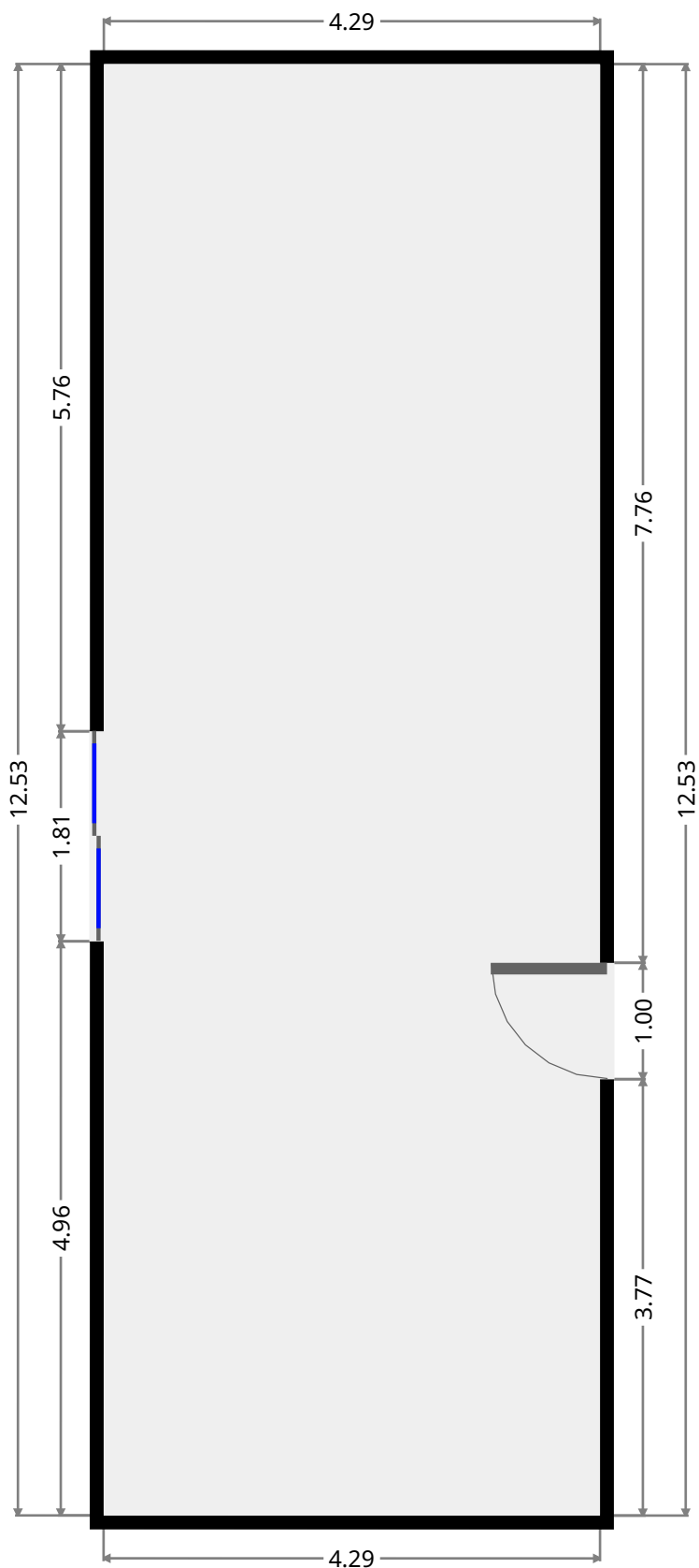
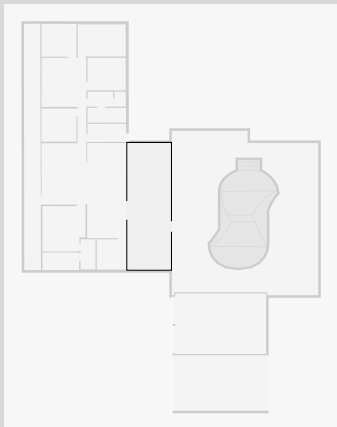

THIS FLOORPLAN IS PROVIDED WITHOUT WARRANTY OF ANY KIND. SENSOPIA DISCLAIMS ANY WARRANTY INCLUDING, WITHOUT LIMITATION, SATISFACTORY QUALITY OR ACCURACY OF DIMENSIONS.

# 140-144 Angela Road

## Bathroom

Width: 1.75 m  
Length: 3.64 m  
Area: 6.38 m<sup>2</sup>  
Perimeter: 10.79 m

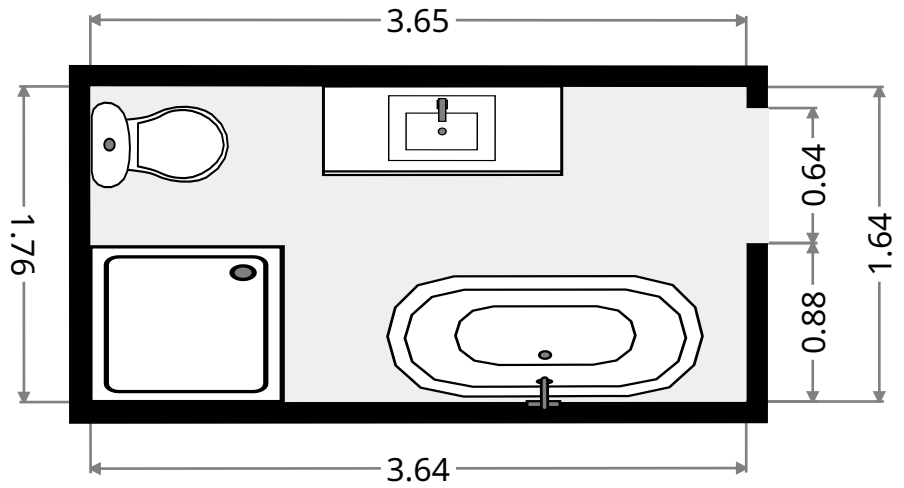
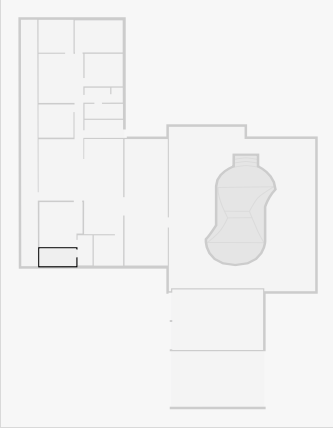

## WIR

Width: 1.48 m  
Length: 2.99 m  
Area: 4.43 m<sup>2</sup>  
Perimeter: 8.94 m

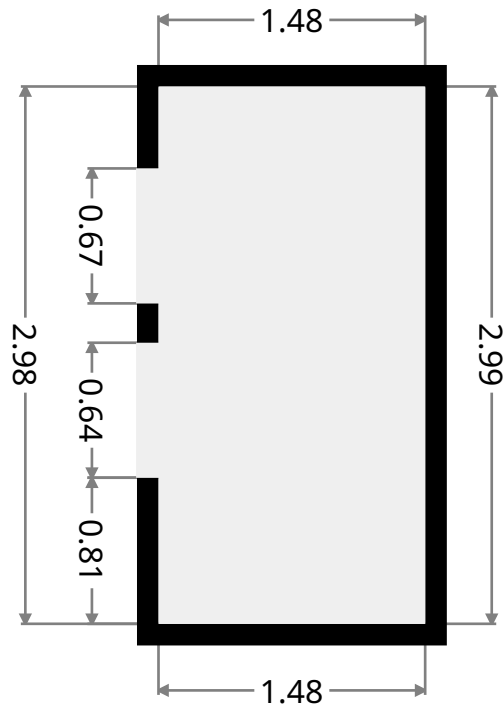
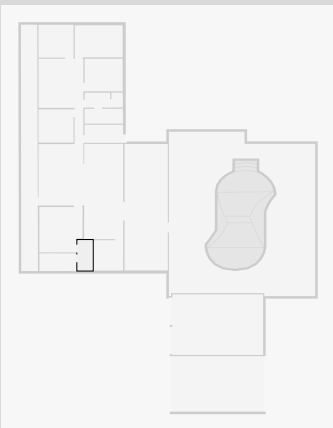

# 140-144 Angela Road

## Master Bedroom

Width: 4.28 m  
 Length: 4.49 m  
 Area: 18.38 m<sup>2</sup>  
 Perimeter: 17.54 m

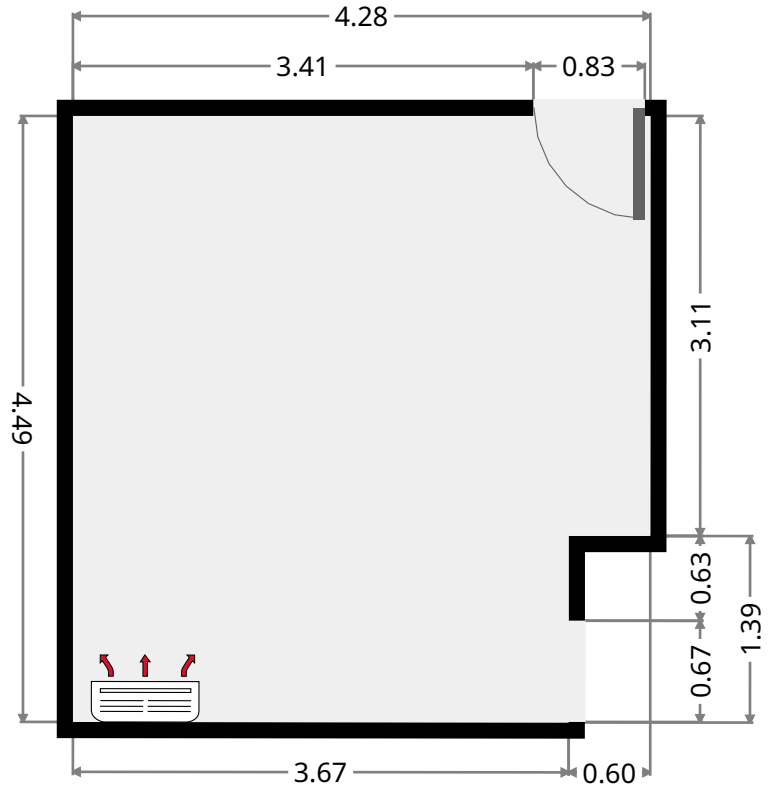
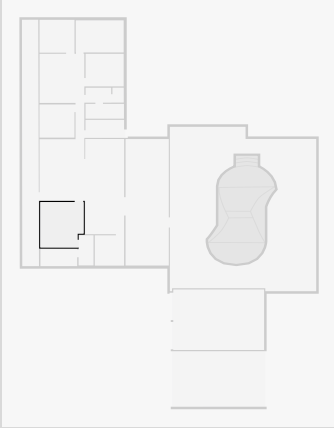

## Bedroom

Width: 3.25 m  
 Length: 3.47 m  
 Area: 11.27 m<sup>2</sup>  
 Perimeter: 13.43 m

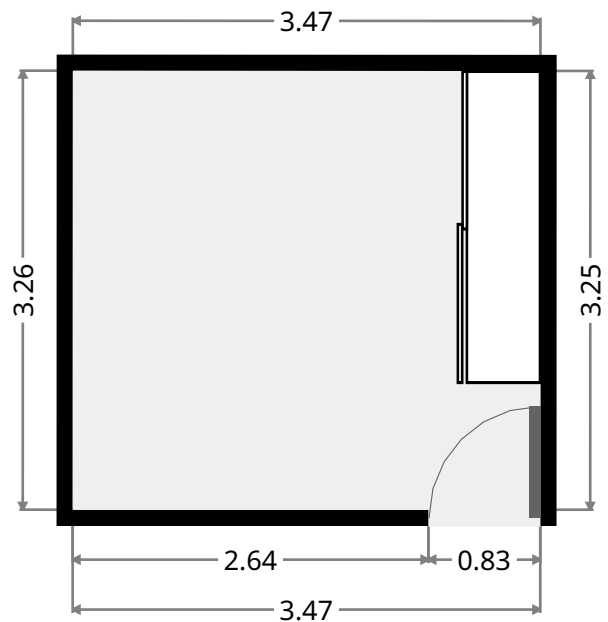
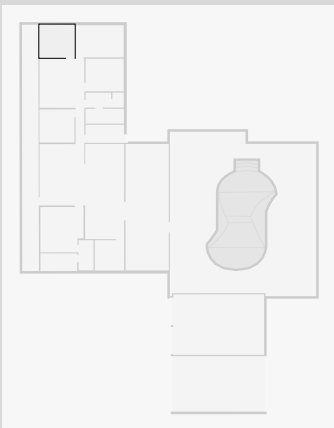

# 140-144 Angela Road

## Bedroom

Width: 3.18 m  
Length: 4.75 m  
Area: 15.11 m<sup>2</sup>  
Perimeter: 15.86 m

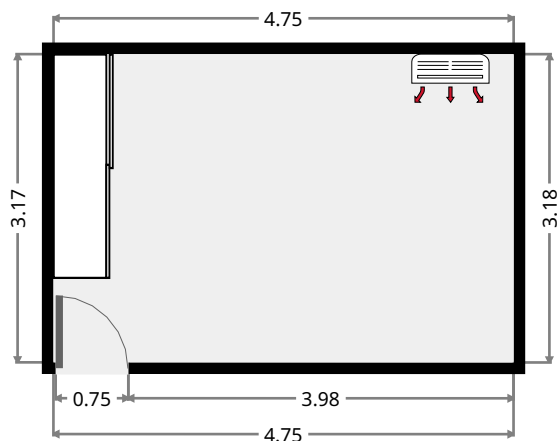
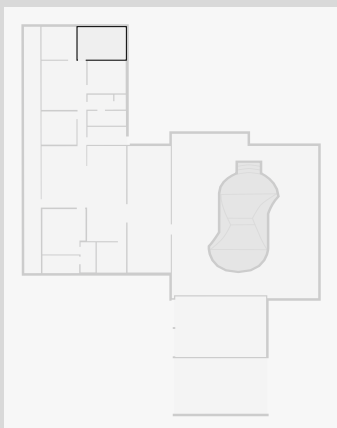

## Living Room

Width: 4.45 m  
Length: 6.08 m  
Area: 26.98 m<sup>2</sup>  
Perimeter: 21.04 m

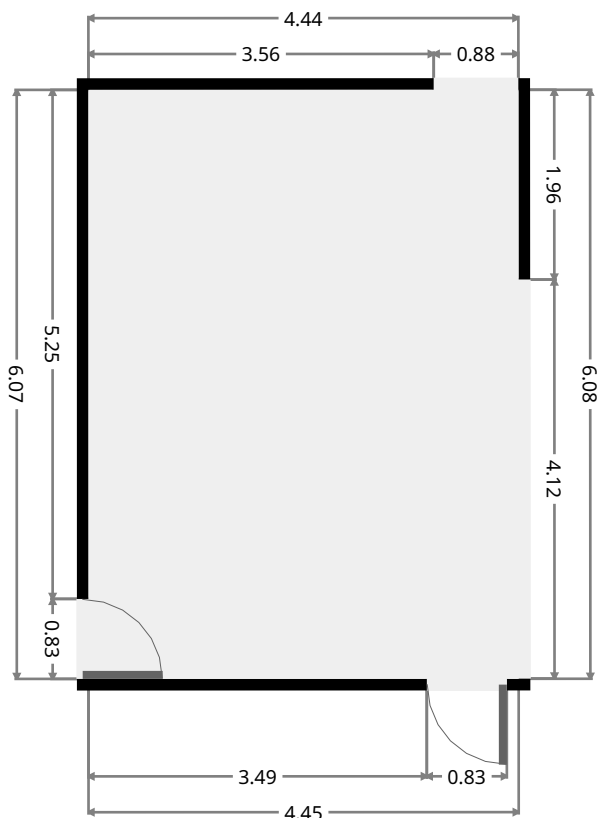
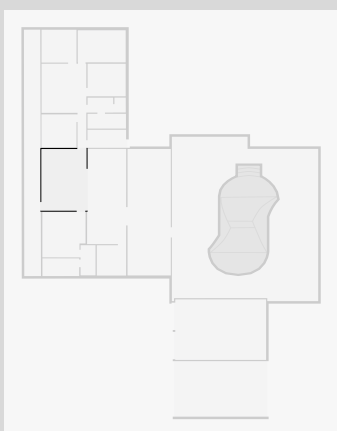

THIS FLOORPLAN IS PROVIDED WITHOUT WARRANTY OF ANY KIND. SENSOPIA DISCLAIMS ANY WARRANTY INCLUDING, WITHOUT LIMITATION, SATISFACTORY QUALITY OR ACCURACY OF DIMENSIONS.

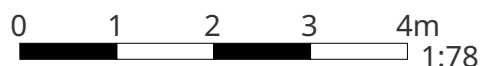



# 140-144 Angela Road

## Toilet

Width: 1.12 m  
Length: 1.48 m  
Area: 1.66 m<sup>2</sup>  
Perimeter: 5.20 m

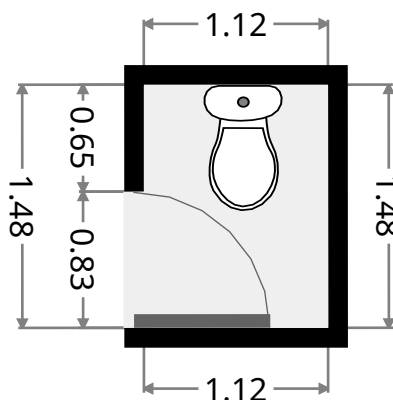

## Laundry Room

Width: 1.79 m  
Length: 3.83 m  
Area: 6.84 m<sup>2</sup>  
Perimeter: 11.23 m

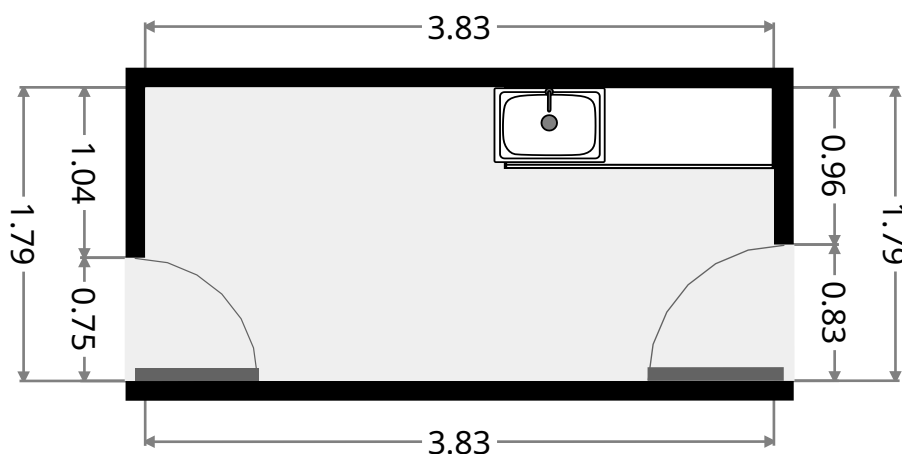

# 140-144 Angela Road

## Bathroom

Width: 1.47 m  
 Length: 3.80 m  
 Area: 5.58 m<sup>2</sup>  
 Perimeter: 10.54 m

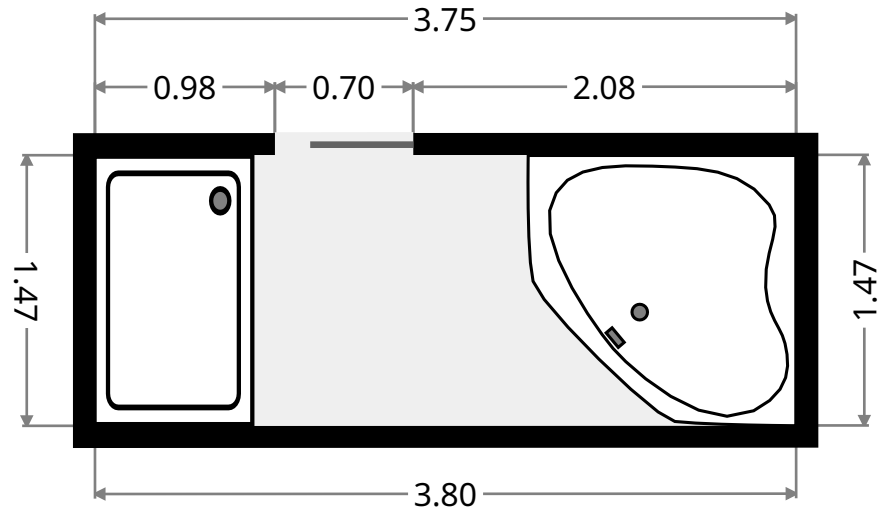
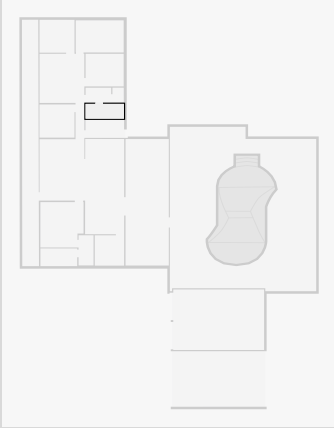

## Hall

Width: 1.48 m  
 Length: 2.54 m  
 Area: 3.76 m<sup>2</sup>  
 Perimeter: 8.04 m

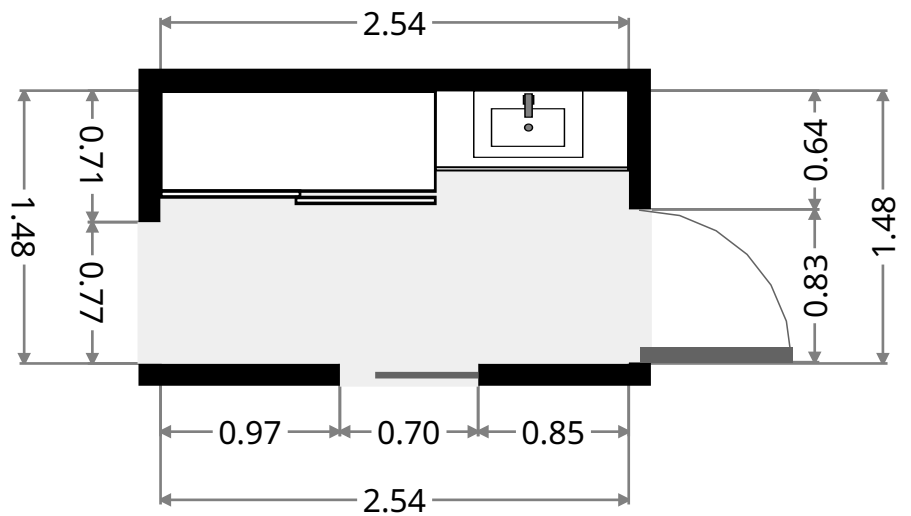
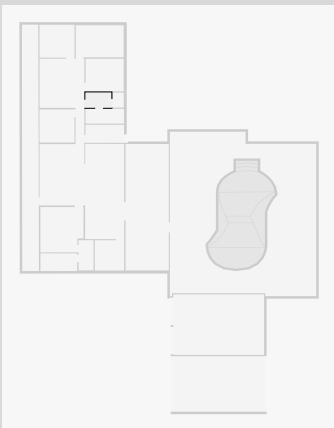

THIS FLOORPLAN IS PROVIDED WITHOUT WARRANTY OF ANY KIND. SENSOPIA DISCLAIMS ANY WARRANTY INCLUDING, WITHOUT LIMITATION, SATISFACTORY QUALITY OR ACCURACY OF DIMENSIONS.

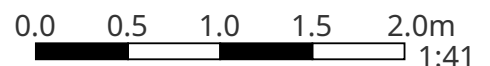

# 140-144 Angela Road

## Living Room

Width: 4.44 m  
 Length: 4.87 m  
 Area: 21.59 m<sup>2</sup>  
 Perimeter: 18.61 m

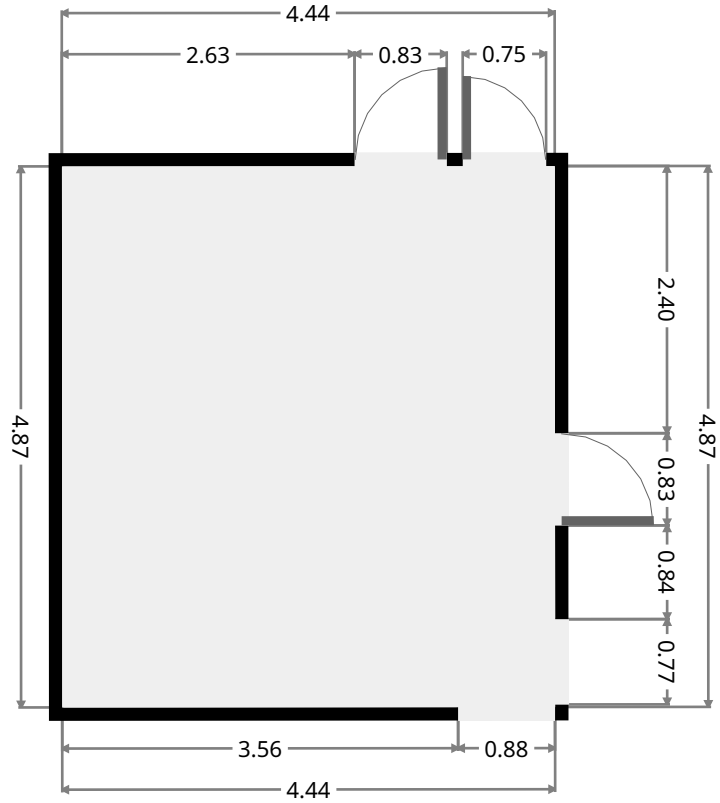
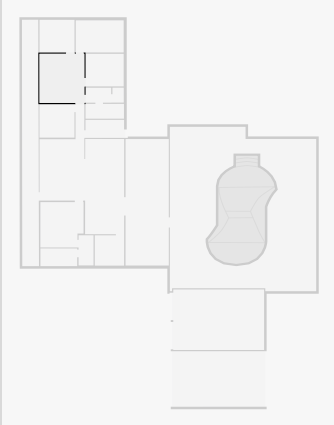

## Bedroom

Width: 3.29 m  
 Length: 3.47 m  
 Area: 11.38 m<sup>2</sup>  
 Perimeter: 13.50 m

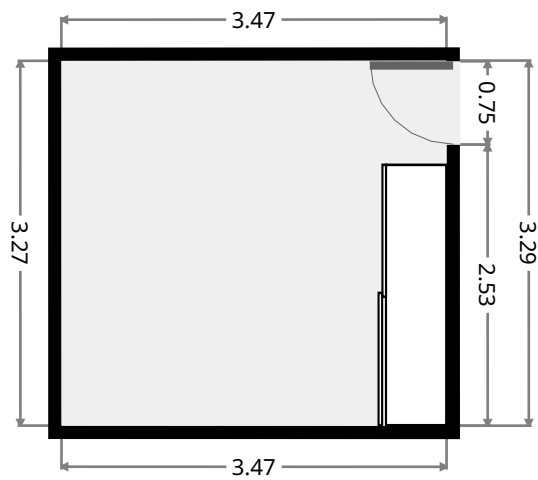
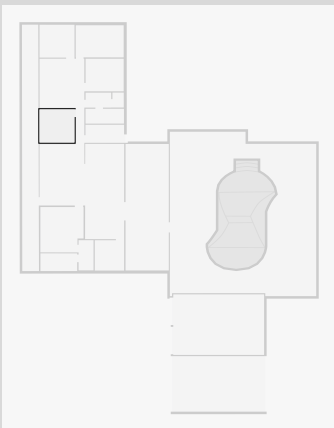

# 140-144 Angela Road

## Hall

Width: 0.88 m  
 Length: 3.38 m  
 Area: 2.94 m<sup>2</sup>  
 Perimeter: 8.50 m

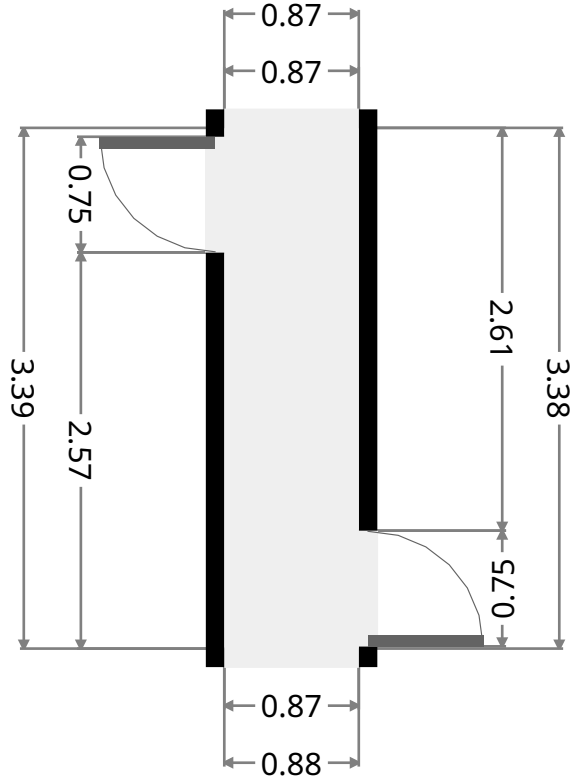
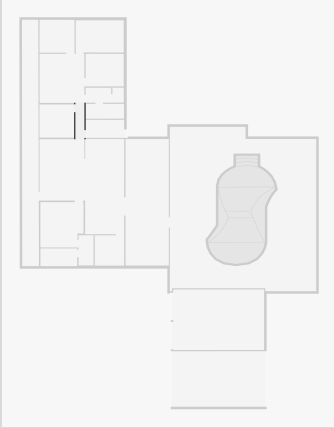

## Study

Width: 2.91 m  
 Length: 3.00 m  
 Area: 8.73 m<sup>2</sup>  
 Perimeter: 11.82 m

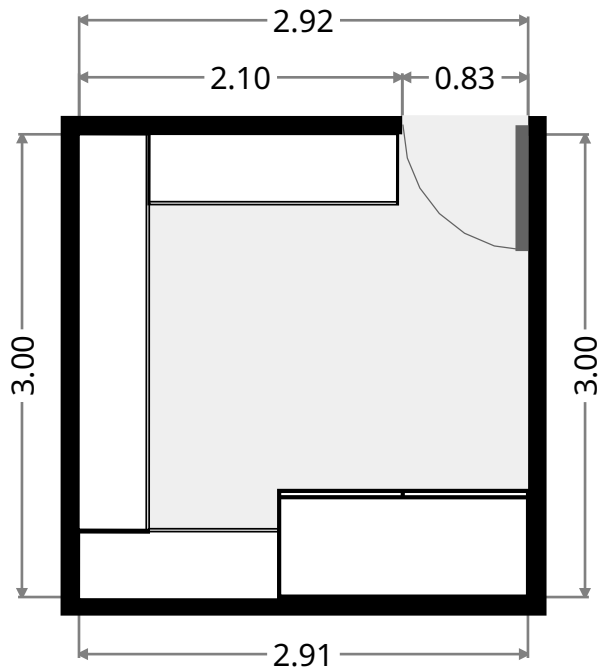
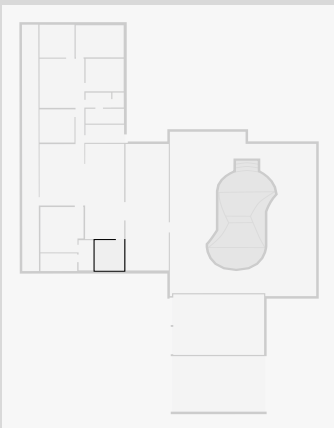

# 140-144 Angela Road

## Kitchen

Width: 3.88 m  
Length: 9.44 m  
Area: 36.49 m<sup>2</sup>  
Perimeter: 26.61 m

