

14 Woodland Drive

Ground Floor

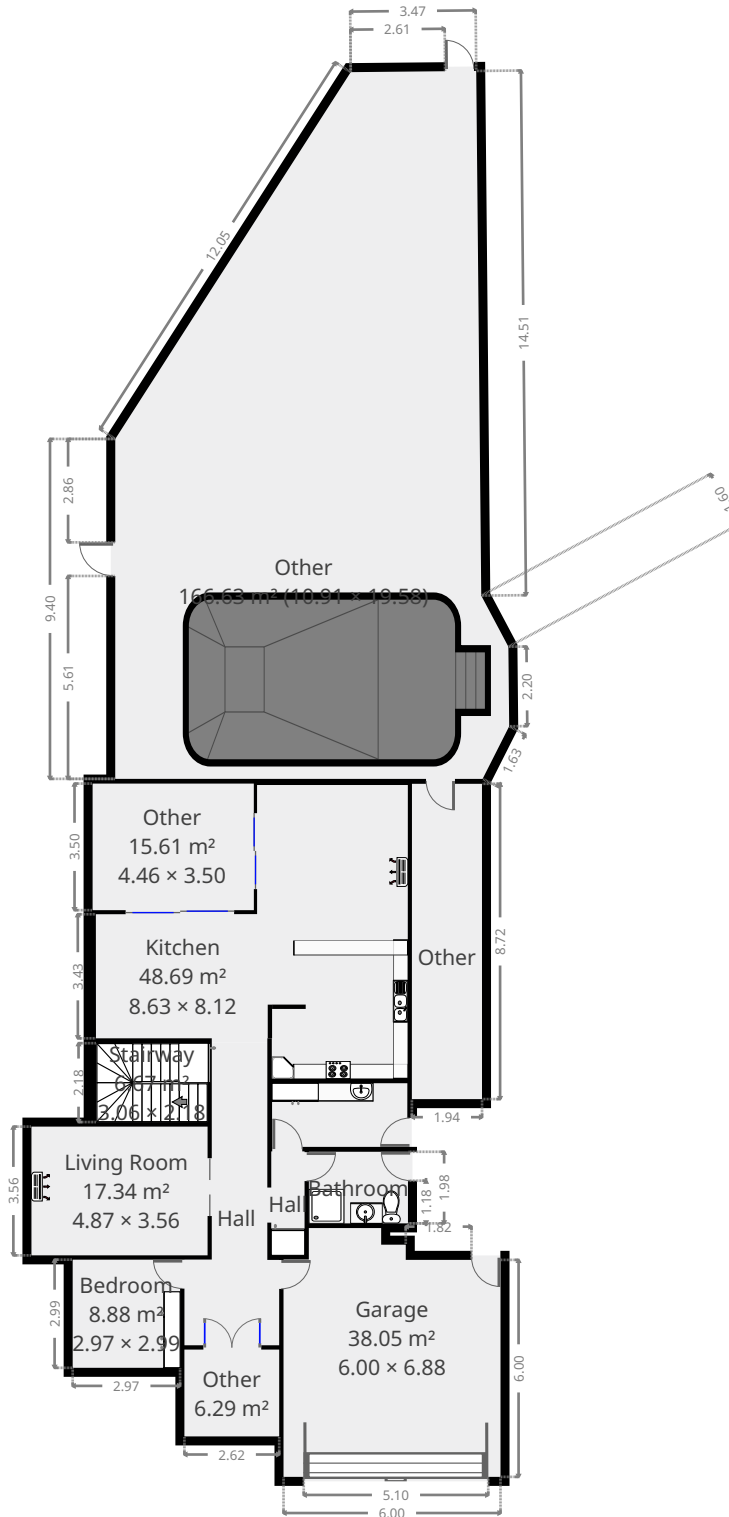

THIS FLOORPLAN IS PROVIDED WITHOUT WARRANTY OF ANY KIND. SENSOPIA DISCLAIMS ANY WARRANTY INCLUDING, WITHOUT LIMITATION, SATISFACTORY QUALITY OR ACCURACY OF DIMENSIONS.



14 Woodland Drive

Hall

Width: 2.62 m
 Length: 8.36 m
 Area: 15.41 m²
 Perimeter: 21.96 m

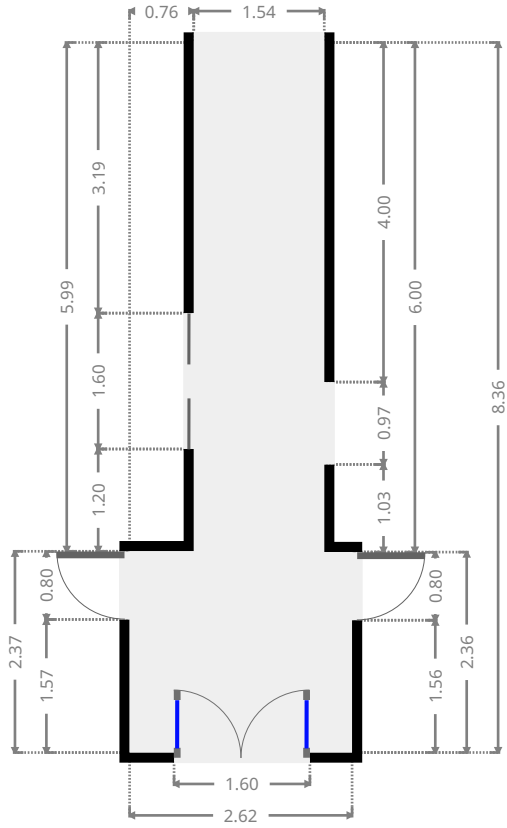
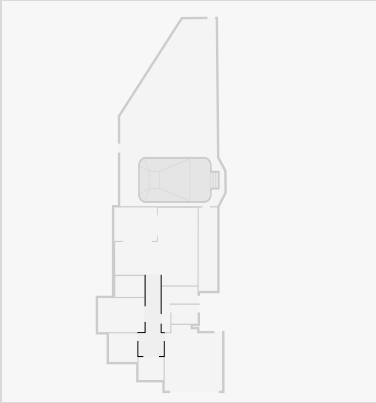

Bedroom

Width: 2.97 m
 Length: 2.99 m
 Area: 8.88 m²
 Perimeter: 11.92 m

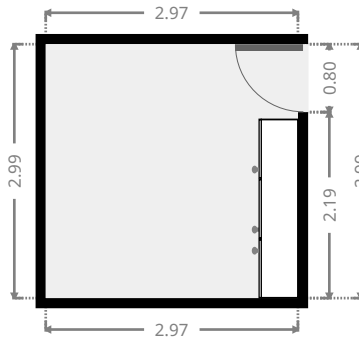
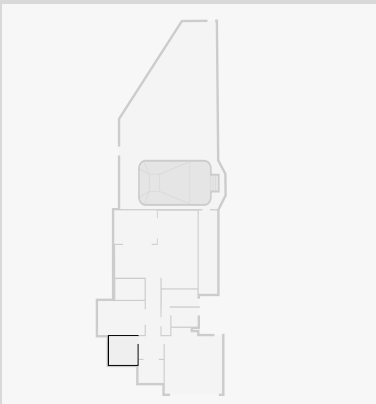

14 Woodland Drive

Garage

Width: 6.00 m
 Length: 6.88 m
 Area: 38.05 m²
 Perimeter: 25.76 m

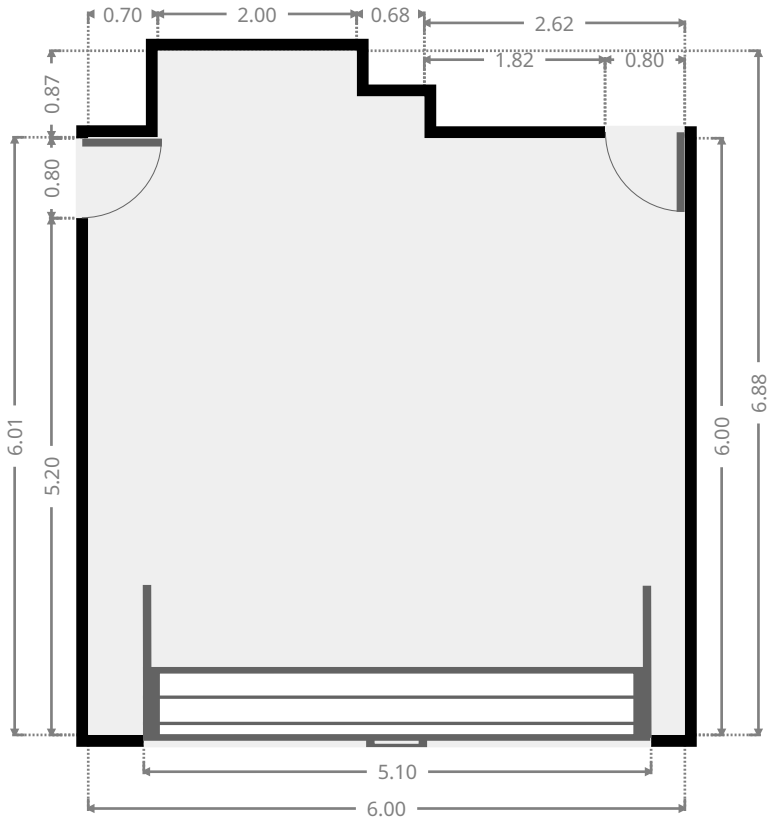
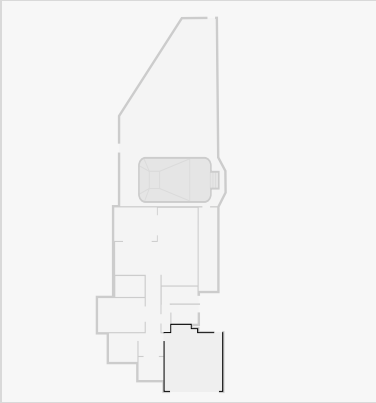

Hall

Width: 0.92 m
 Length: 2.88 m
 Area: 2.65 m²
 Perimeter: 7.60 m

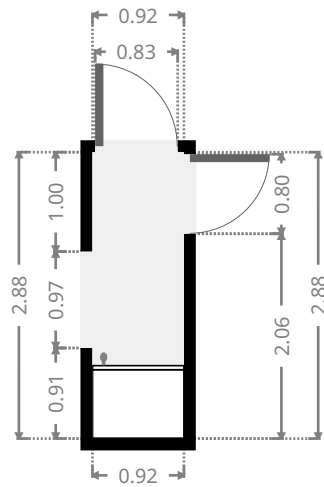
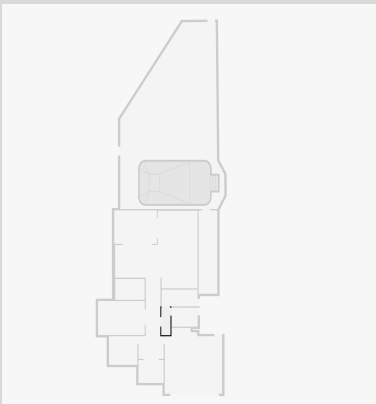

THIS FLOORPLAN IS PROVIDED WITHOUT WARRANTY OF ANY KIND. SENSOPIA DISCLAIMS ANY WARRANTY INCLUDING, WITHOUT LIMITATION, SATISFACTORY QUALITY OR ACCURACY OF DIMENSIONS.

14 Woodland Drive

Bathroom

Width: 1.98 m
 Length: 2.74 m
 Area: 5.43 m²
 Perimeter: 9.44 m

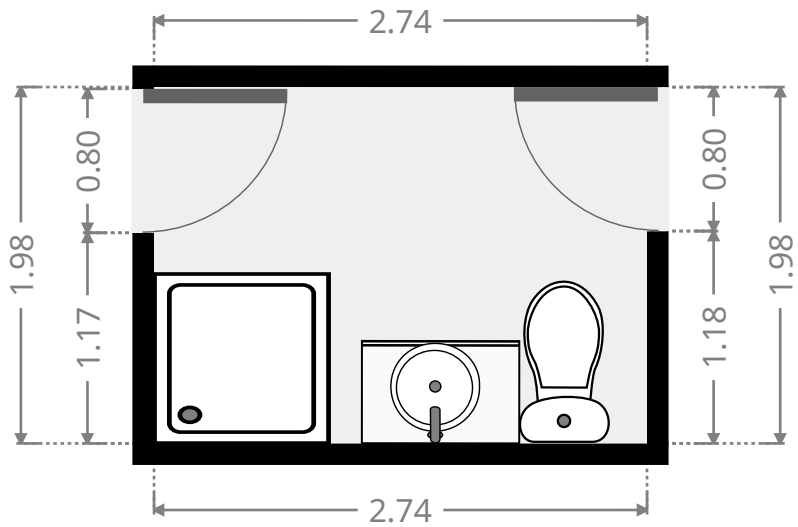
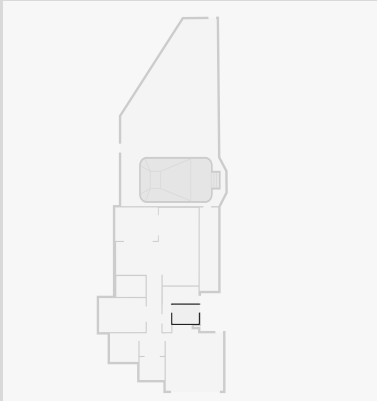

Laundry Room

Width: 1.76 m
 Length: 3.74 m
 Area: 6.58 m²
 Perimeter: 11.00 m

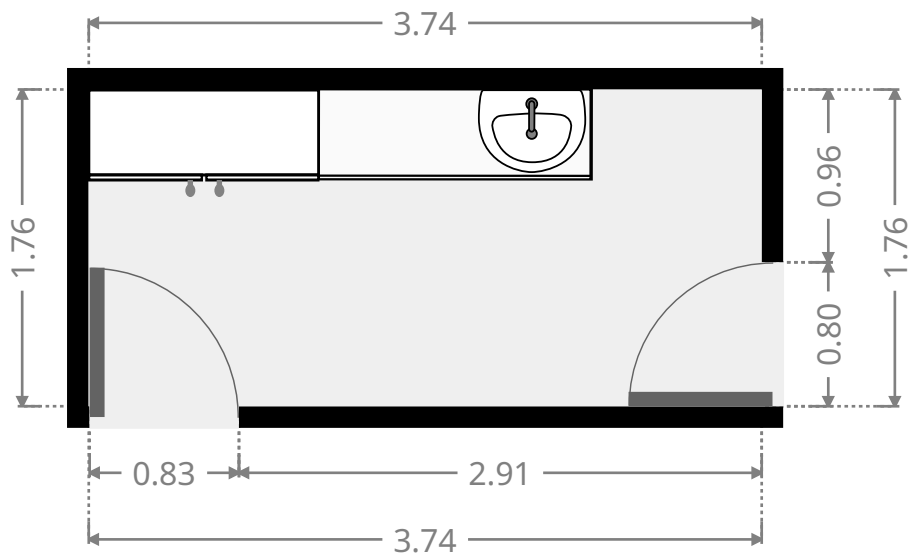
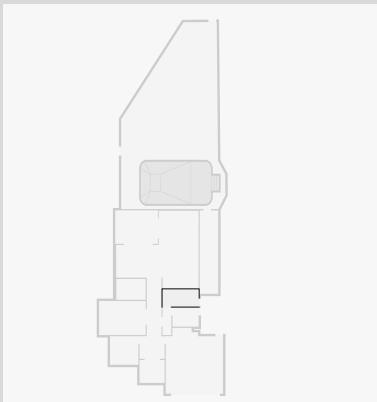

THIS FLOORPLAN IS PROVIDED WITHOUT WARRANTY OF ANY KIND. SENSOPIA DISCLAIMS ANY WARRANTY INCLUDING, WITHOUT LIMITATION, SATISFACTORY QUALITY OR ACCURACY OF DIMENSIONS.

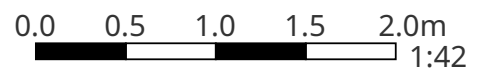

14 Woodland Drive

Living Room

Width: 3.56 m
Length: 4.87 m
Area: 17.34 m²
Perimeter: 16.86 m

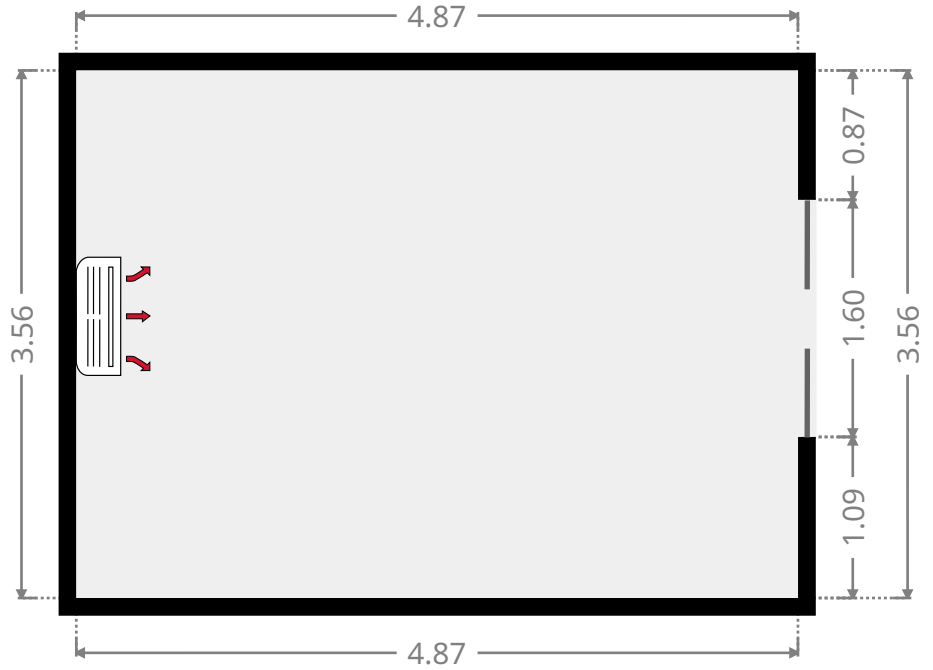
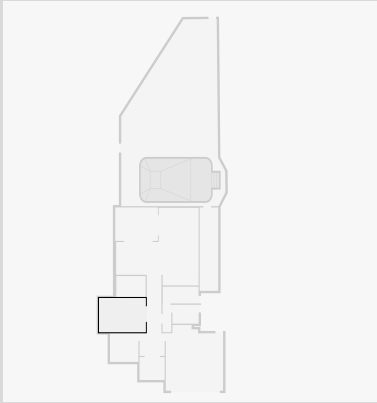

Stairway

Width: 2.18 m
Length: 3.06 m
Area: 6.67 m²
Perimeter: 10.48 m

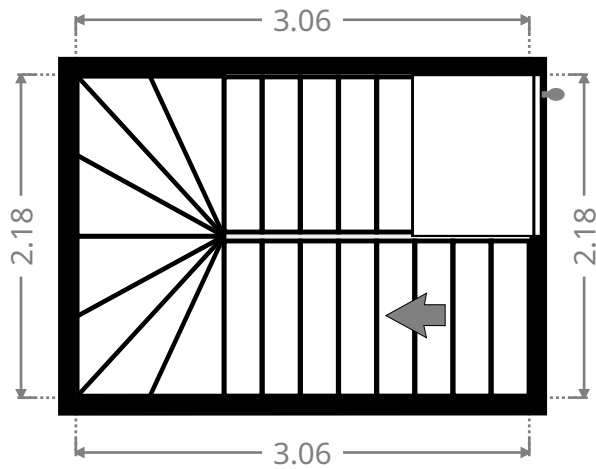
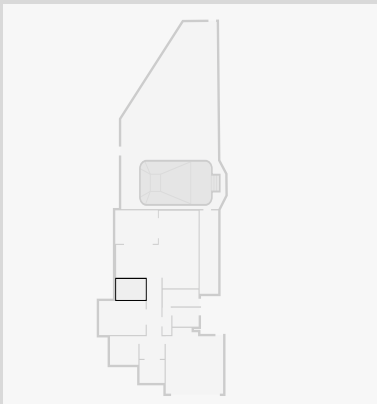

14 Woodland Drive

Kitchen

Width: 8.12 m
 Length: 8.63 m
 Area: 48.69 m²
 Perimeter: 33.49 m

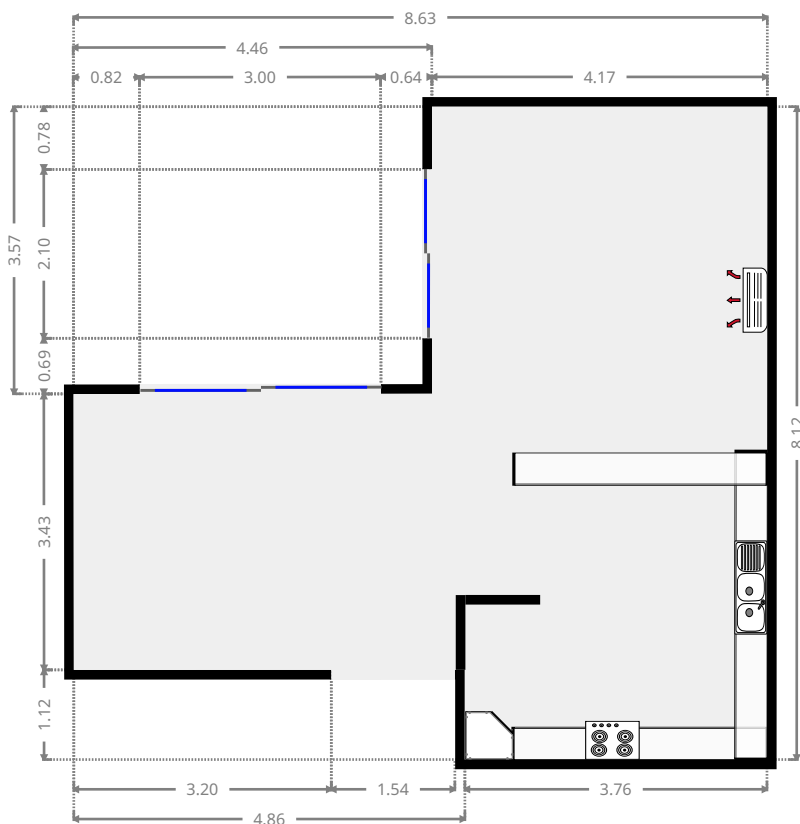
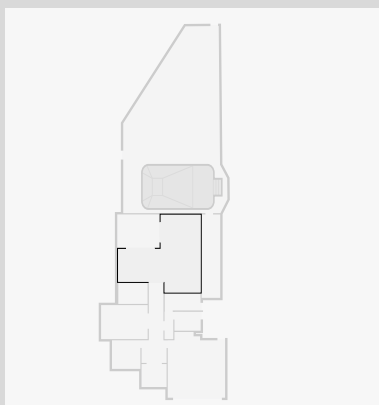

Other

Width: 3.50 m
 Length: 4.46 m
 Area: 15.61 m²
 Perimeter: 15.92 m

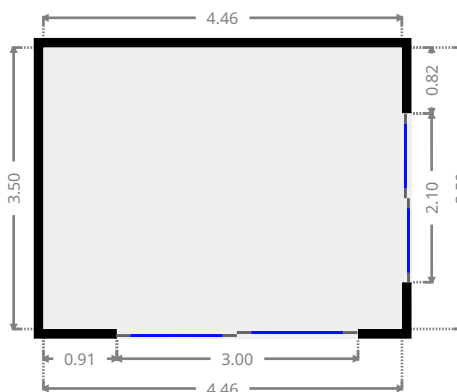
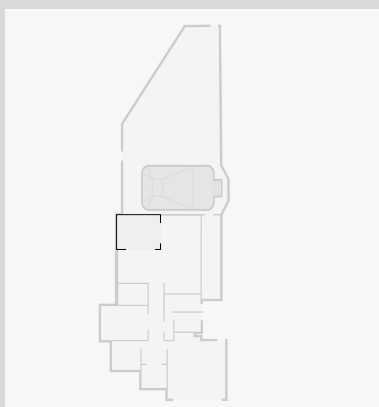

14 Woodland Drive

Other

Width: 10.91 m
Length: 19.58 m
Area: 166.63 m²
Perimeter: 55.02 m

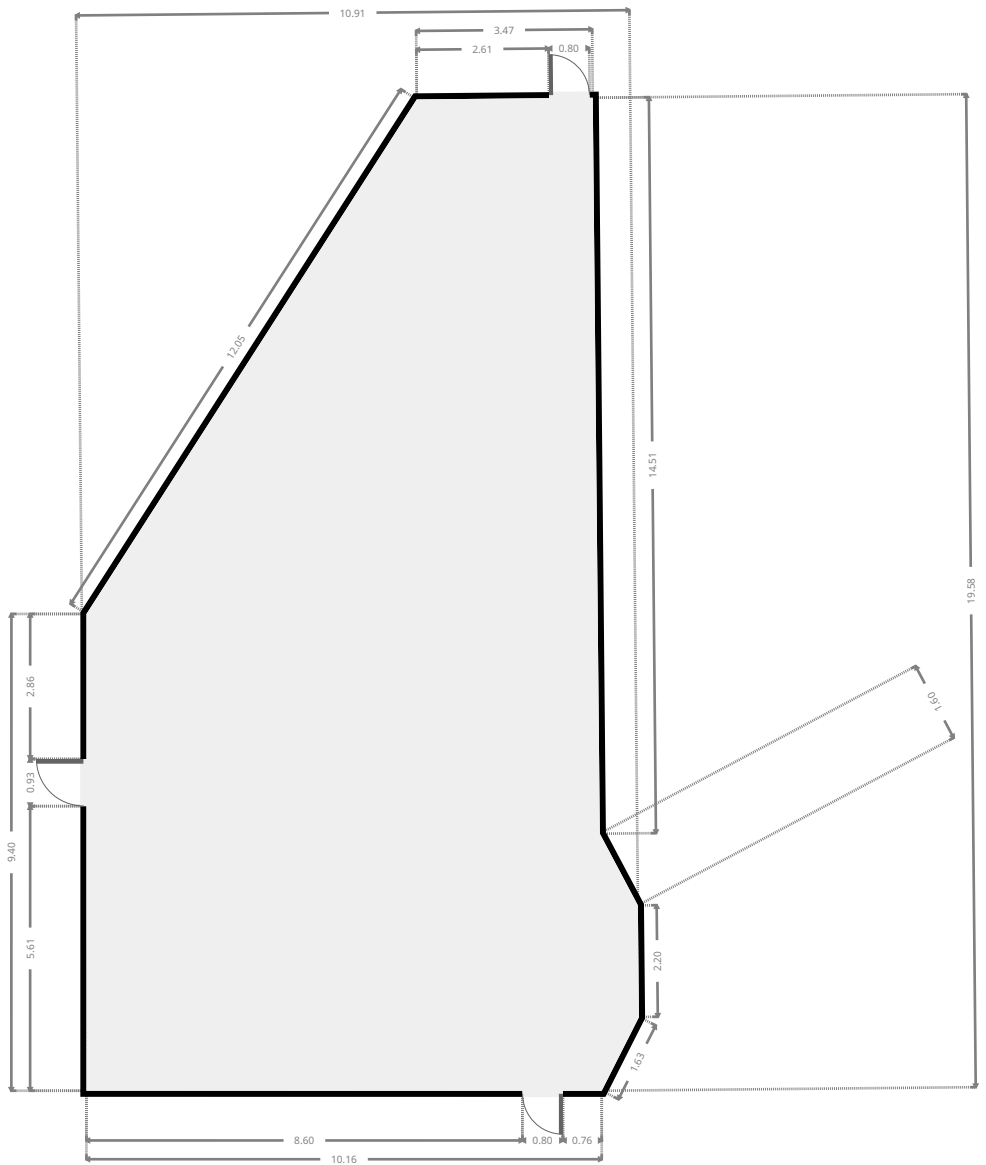
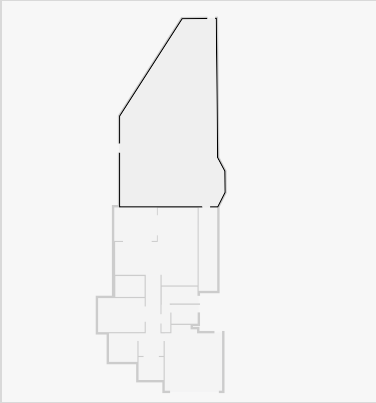

THIS FLOORPLAN IS PROVIDED WITHOUT WARRANTY OF ANY KIND. SENSOPIA DISCLAIMS ANY WARRANTY INCLUDING, WITHOUT LIMITATION, SATISFACTORY QUALITY OR ACCURACY OF DIMENSIONS.



14 Woodland Drive

Other

Width: 1.94 m
Length: 8.72 m
Area: 16.90 m²
Perimeter: 21.31 m

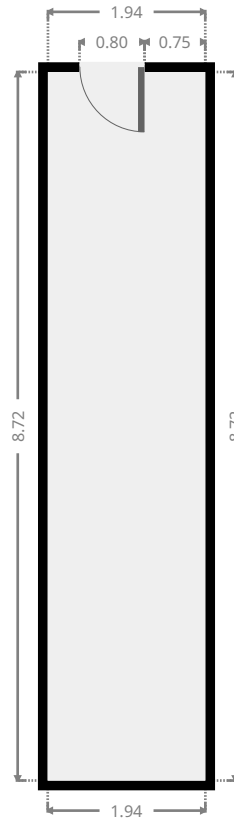
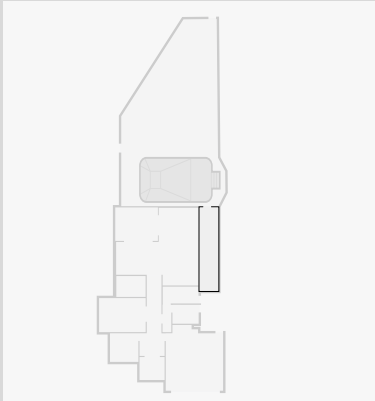

Other

Width: 2.40 m
Length: 2.62 m
Area: 6.29 m²
Perimeter: 10.04 m

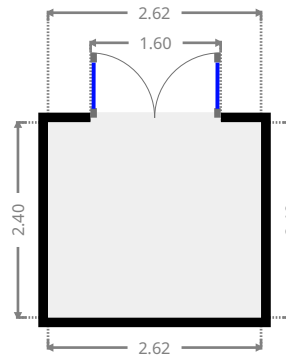
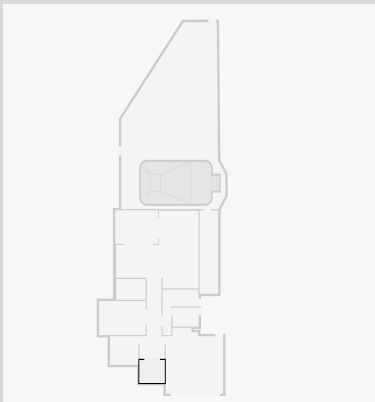

14 Woodland Drive

1st Floor

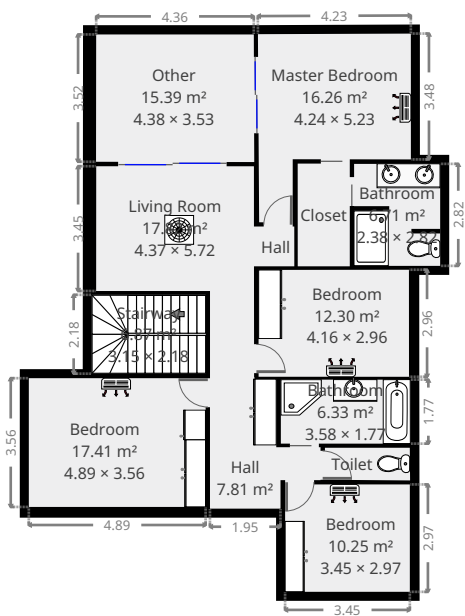

THIS FLOORPLAN IS PROVIDED WITHOUT WARRANTY OF ANY KIND. SENSOPIA DISCLAIMS ANY WARRANTY INCLUDING, WITHOUT LIMITATION, SATISFACTORY QUALITY OR ACCURACY OF DIMENSIONS.



14 Woodland Drive

Bedroom

Width: 2.97 m
 Length: 3.45 m
 Area: 10.25 m²
 Perimeter: 12.84 m

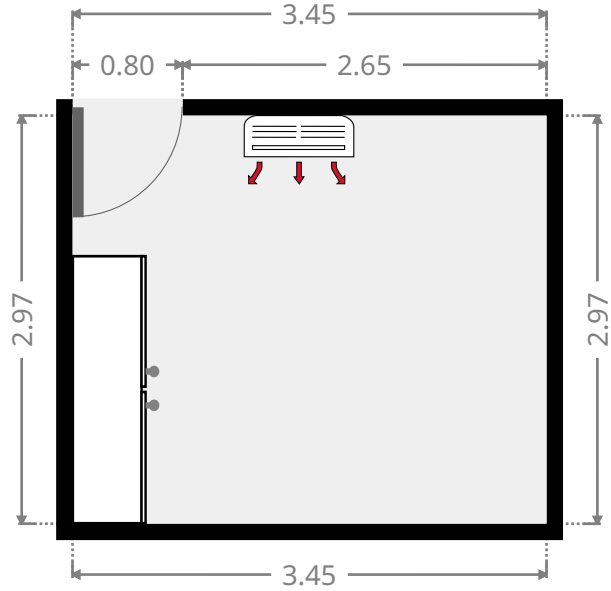
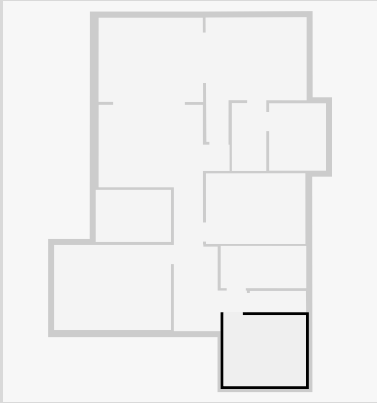

Hall

Width: 3.06 m
 Length: 3.63 m
 Area: 7.81 m²
 Perimeter: 13.37 m

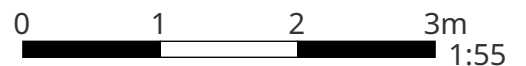
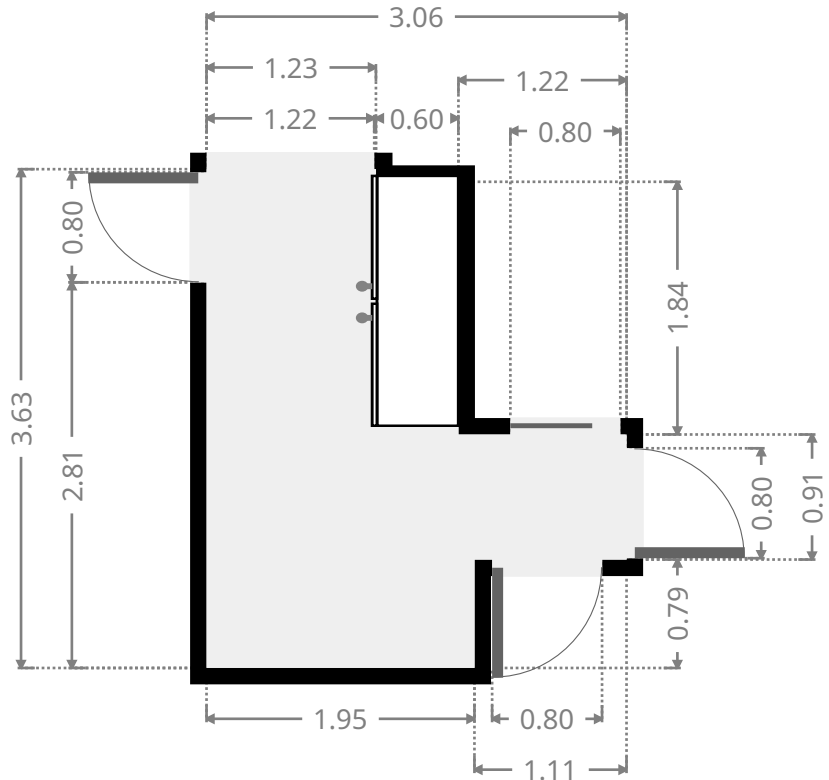
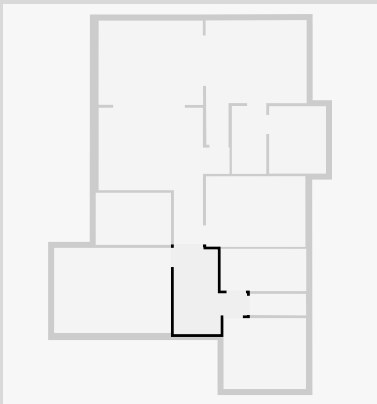

THIS FLOORPLAN IS PROVIDED WITHOUT WARRANTY OF ANY KIND. SENSOPIA DISCLAIMS ANY WARRANTY INCLUDING, WITHOUT LIMITATION, SATISFACTORY QUALITY OR ACCURACY OF DIMENSIONS.

14 Woodland Drive

Bathroom

Width: 1.77 m
Length: 3.58 m
Area: 6.33 m²
Perimeter: 10.70 m

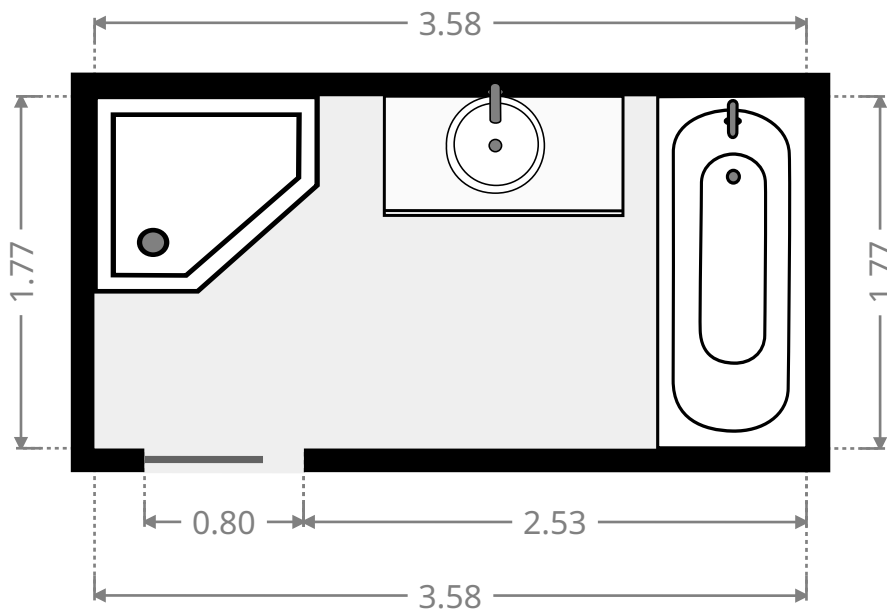
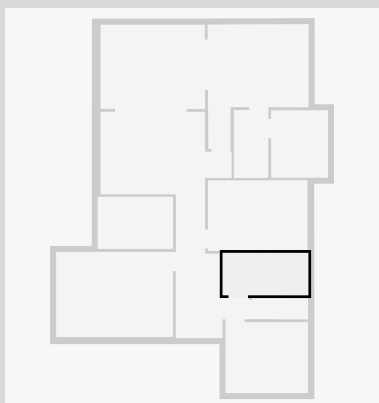

Toilet / Half Bath

Width: 0.90 m
Length: 2.36 m
Area: 2.10 m²
Perimeter: 6.49 m

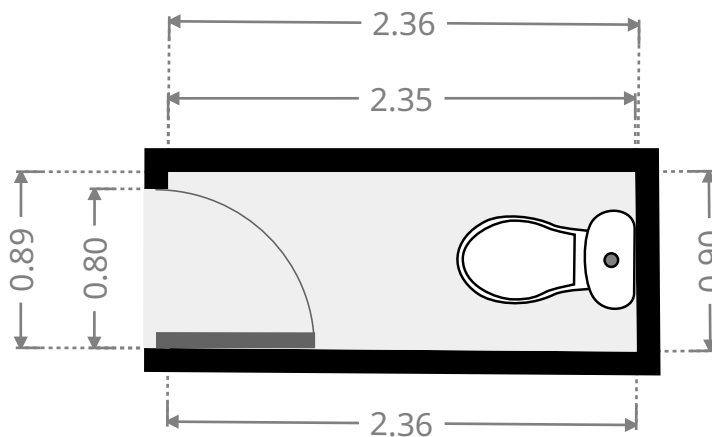
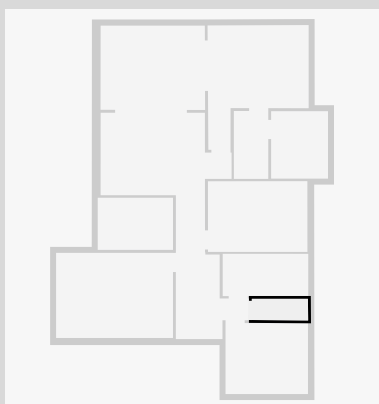

14 Woodland Drive

Bedroom

Width: 3.56 m
 Length: 4.89 m
 Area: 17.41 m²
 Perimeter: 16.90 m

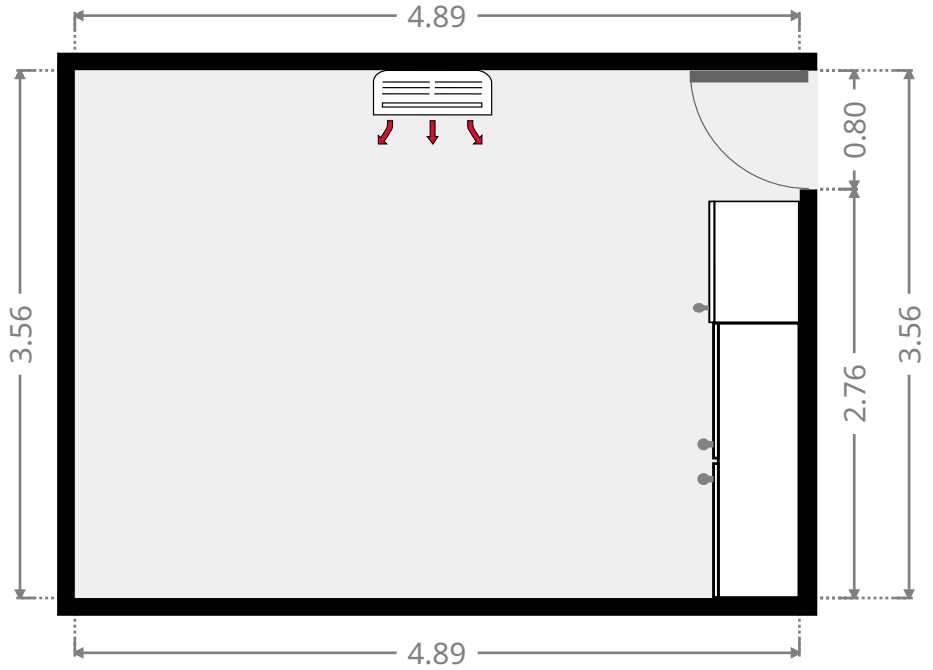
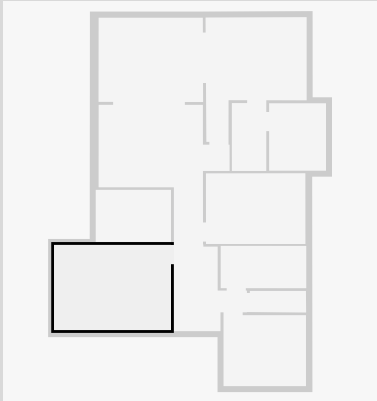

Stairway

Width: 2.18 m
 Length: 3.15 m
 Area: 6.87 m²
 Perimeter: 10.66 m

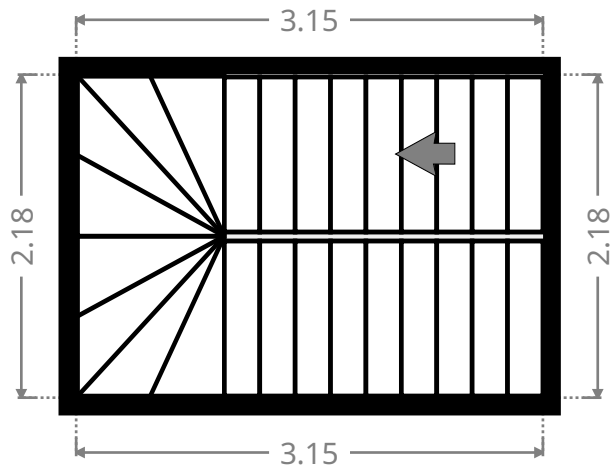
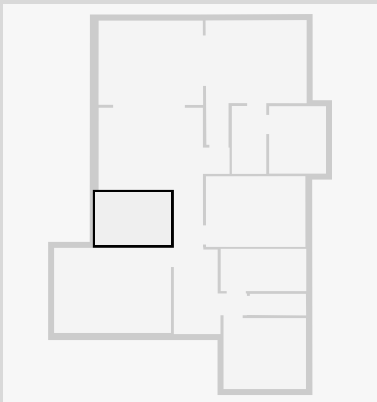

THIS FLOORPLAN IS PROVIDED WITHOUT WARRANTY OF ANY KIND. SENSOPIA DISCLAIMS ANY WARRANTY INCLUDING, WITHOUT LIMITATION, SATISFACTORY QUALITY OR ACCURACY OF DIMENSIONS.

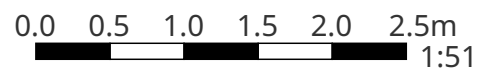

14 Woodland Drive

Living Room

Width: 4.37 m
 Length: 5.72 m
 Area: 17.82 m²
 Perimeter: 20.17 m

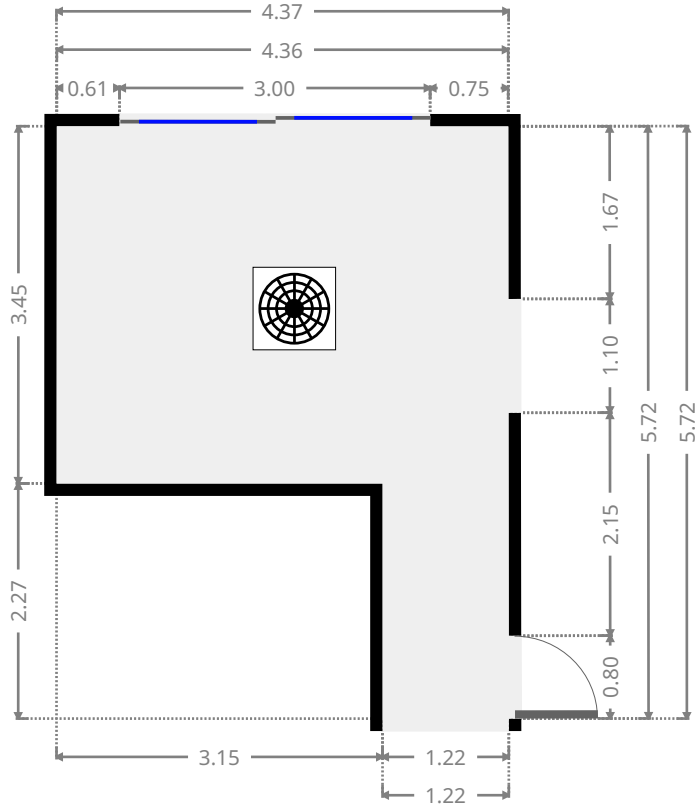
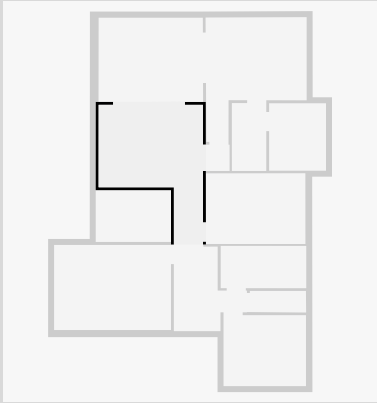

Hall

Width: 1.02 m
 Length: 1.10 m
 Area: 1.12 m²
 Perimeter: 4.24 m

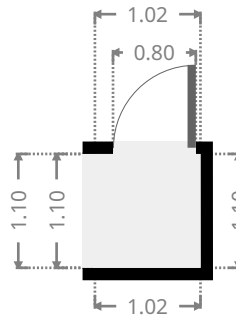
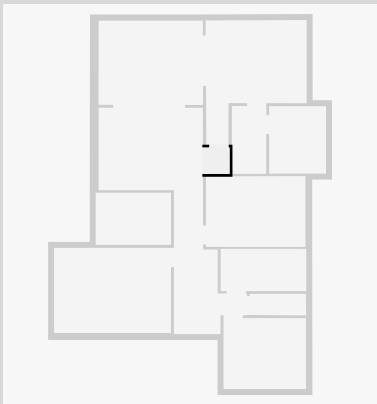

14 Woodland Drive

Master Bedroom

Width: 4.24 m
 Length: 5.23 m
 Area: 16.26 m²
 Perimeter: 18.86 m

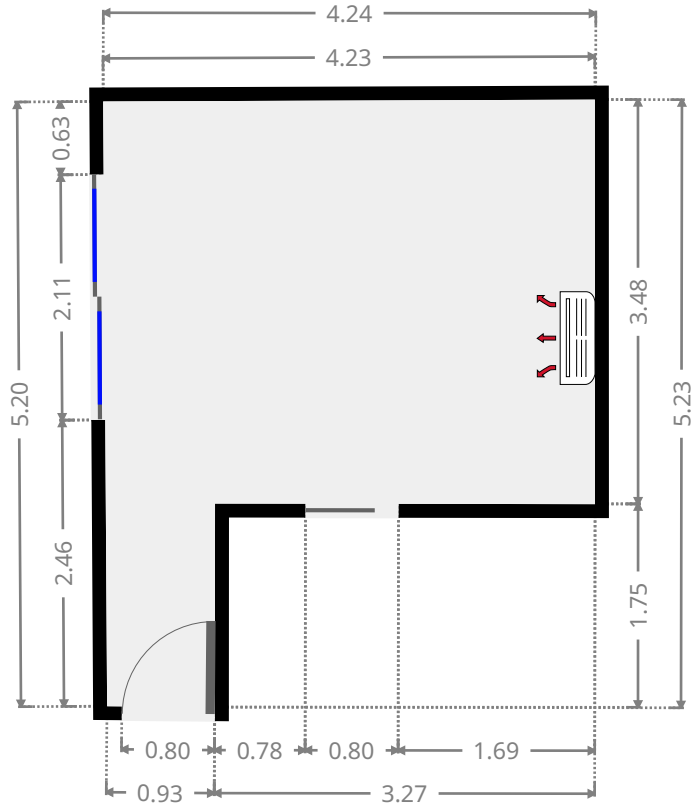
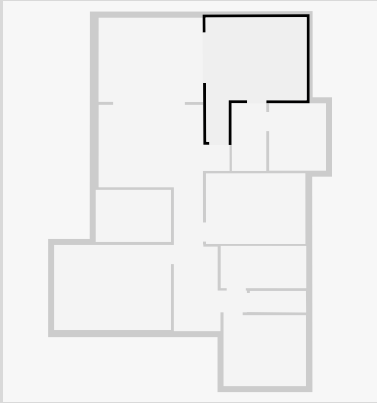

Closet

Width: 1.44 m
 Length: 2.84 m
 Area: 4.09 m²
 Perimeter: 8.56 m

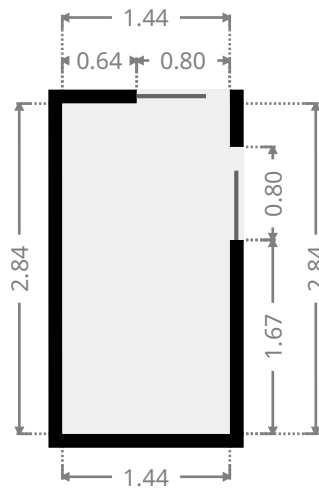
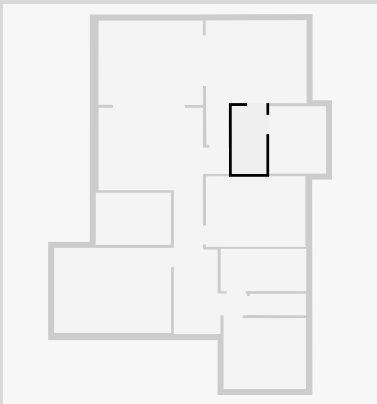

14 Woodland Drive

Bathroom

Width: 2.38 m
 Length: 2.82 m
 Area: 6.71 m²
 Perimeter: 10.40 m

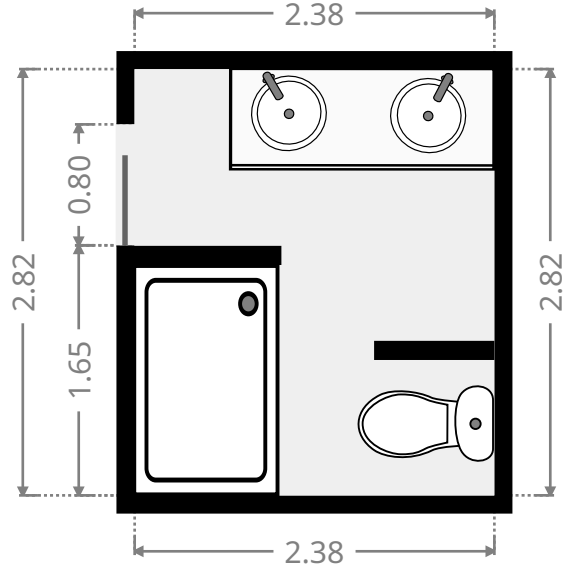
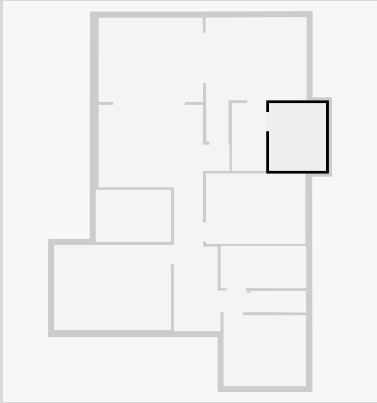

Other

Width: 3.53 m
 Length: 4.38 m
 Area: 15.39 m²
 Perimeter: 15.78 m

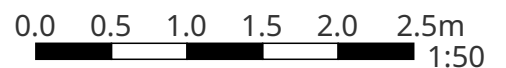
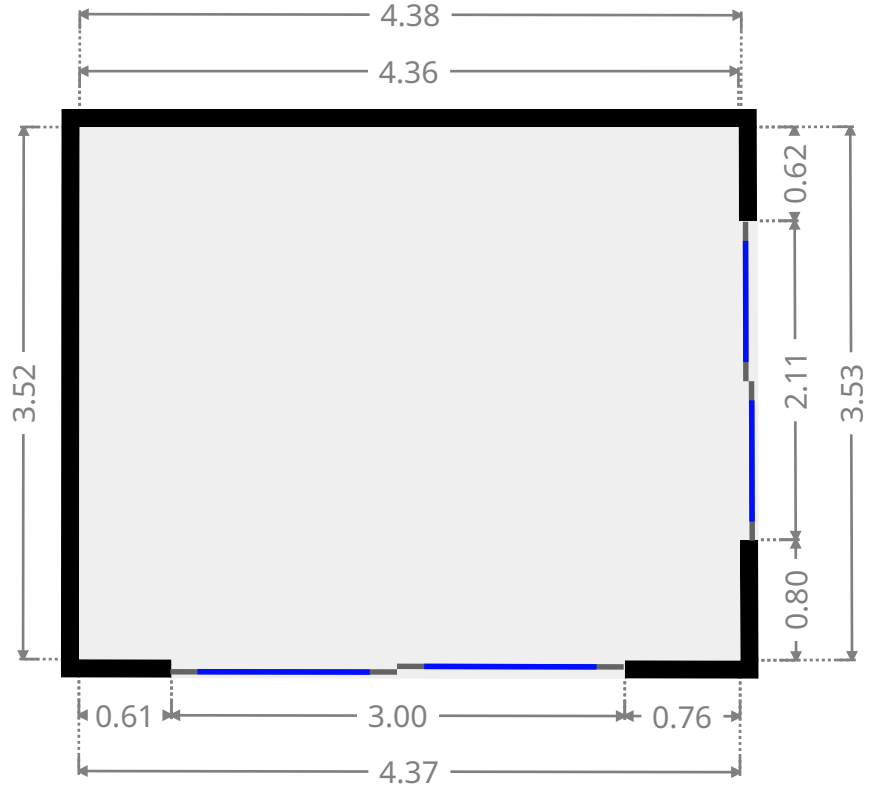
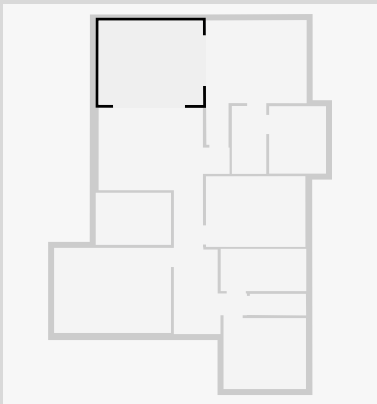

THIS FLOORPLAN IS PROVIDED WITHOUT WARRANTY OF ANY KIND. SENSOPIA DISCLAIMS ANY WARRANTY INCLUDING, WITHOUT LIMITATION, SATISFACTORY QUALITY OR ACCURACY OF DIMENSIONS.

14 Woodland Drive

Bedroom

Width: 2.96 m
Length: 4.16 m
Area: 12.30 m²
Perimeter: 14.24 m

