

14 Webster Street

Ground Floor

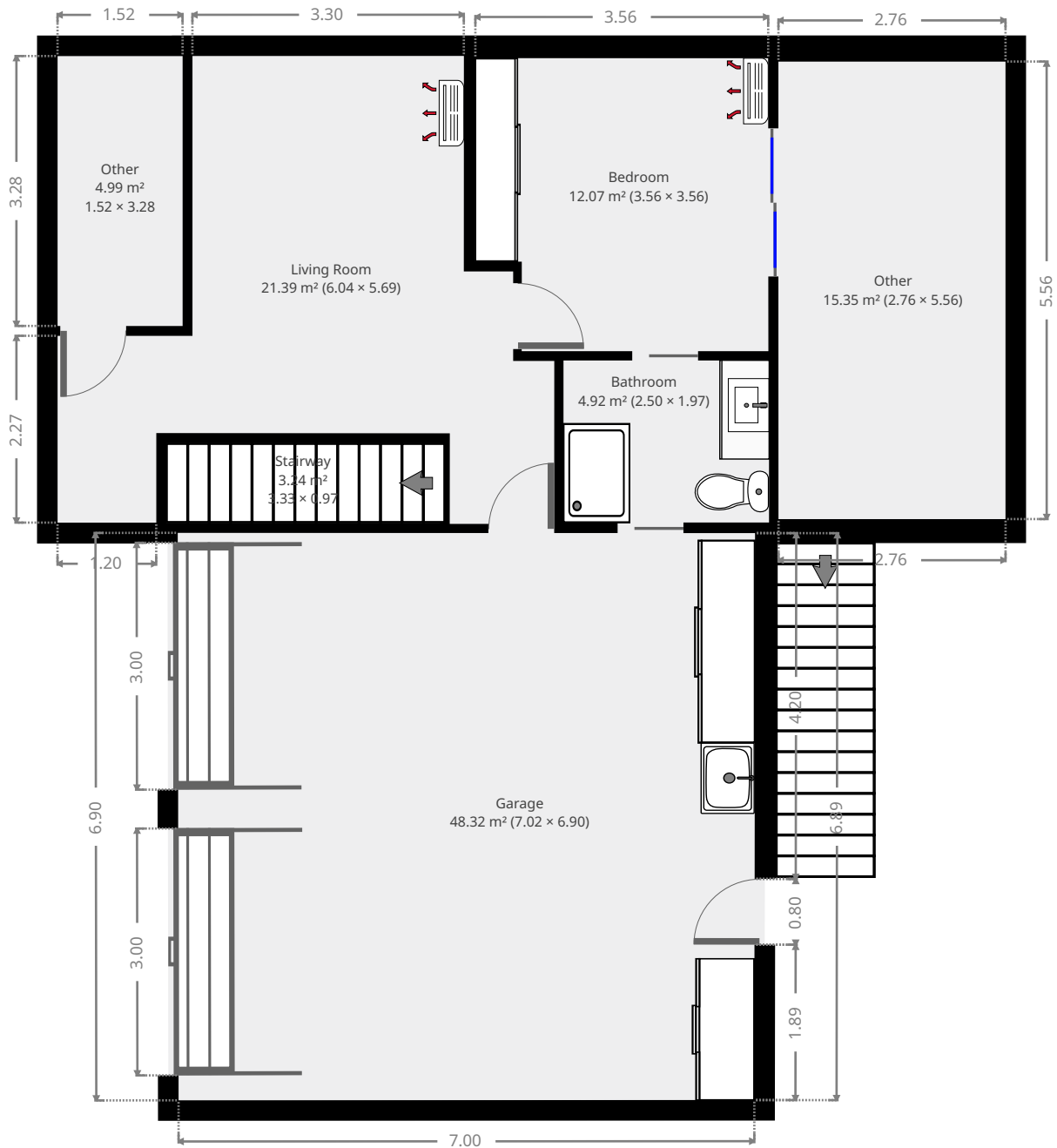

THIS FLOORPLAN IS PROVIDED WITHOUT WARRANTY OF ANY KIND. SENSOPIA DISCLAIMS ANY WARRANTY INCLUDING, WITHOUT LIMITATION, SATISFACTORY QUALITY OR ACCURACY OF DIMENSIONS.



14 Webster Street

Living Room

Width: 5.69 m
 Length: 6.04 m
 Area: 21.39 m²
 Perimeter: 25.63 m

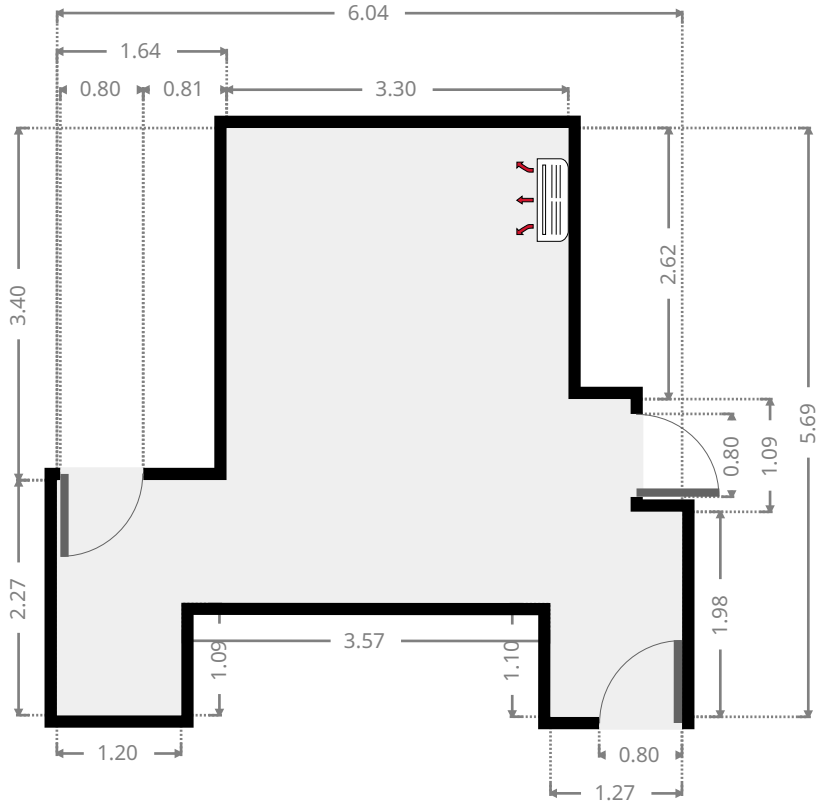
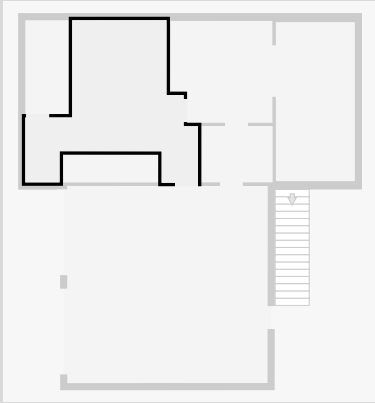

Bedroom

Width: 3.56 m
 Length: 3.56 m
 Area: 12.07 m²
 Perimeter: 14.25 m

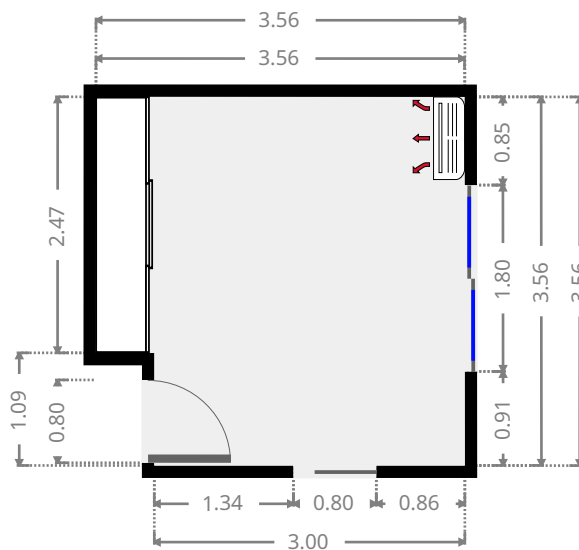
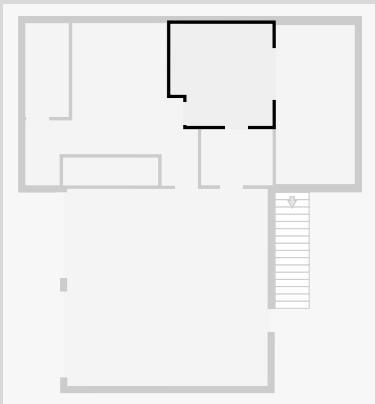

THIS FLOORPLAN IS PROVIDED WITHOUT WARRANTY OF ANY KIND. SENSOPIA DISCLAIMS ANY WARRANTY INCLUDING, WITHOUT LIMITATION, SATISFACTORY QUALITY OR ACCURACY OF DIMENSIONS.



14 Webster Street

Bathroom

Width: 1.97 m
 Length: 2.50 m
 Area: 4.92 m²
 Perimeter: 8.94 m

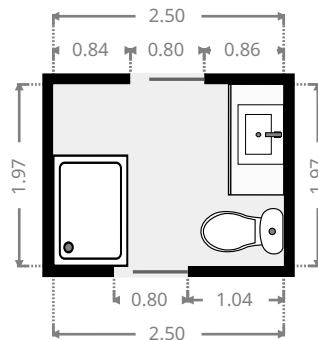
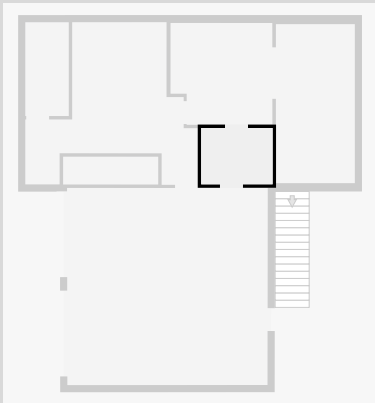

Garage

Width: 6.90 m
 Length: 7.02 m
 Area: 48.32 m²
 Perimeter: 27.81 m

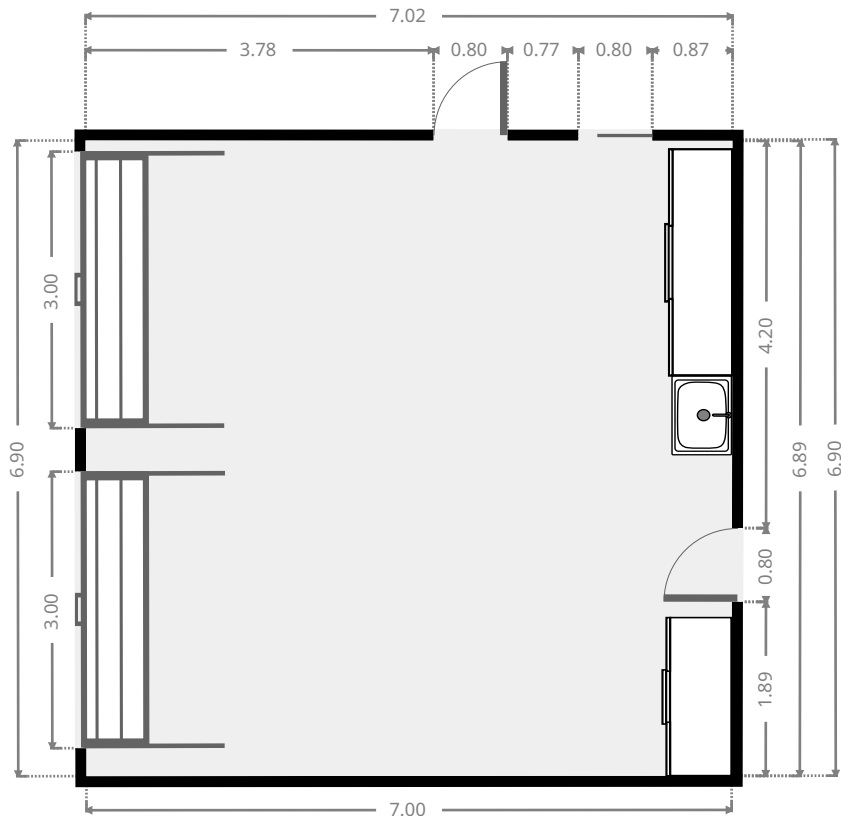
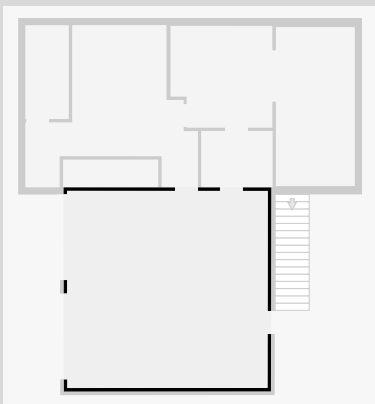

THIS FLOORPLAN IS PROVIDED WITHOUT WARRANTY OF ANY KIND. SENSOPIA DISCLAIMS ANY WARRANTY INCLUDING, WITHOUT LIMITATION, SATISFACTORY QUALITY OR ACCURACY OF DIMENSIONS.

14 Webster Street

Stairway

Width: 0.97 m
 Length: 3.33 m
 Area: 3.24 m²
 Perimeter: 8.60 m

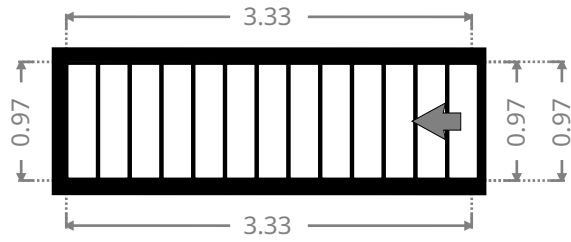
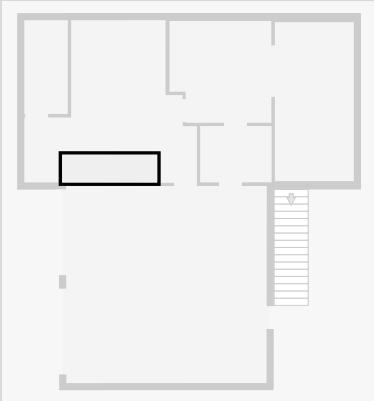

Other

Width: 2.76 m
 Length: 5.56 m
 Area: 15.35 m²
 Perimeter: 16.64 m

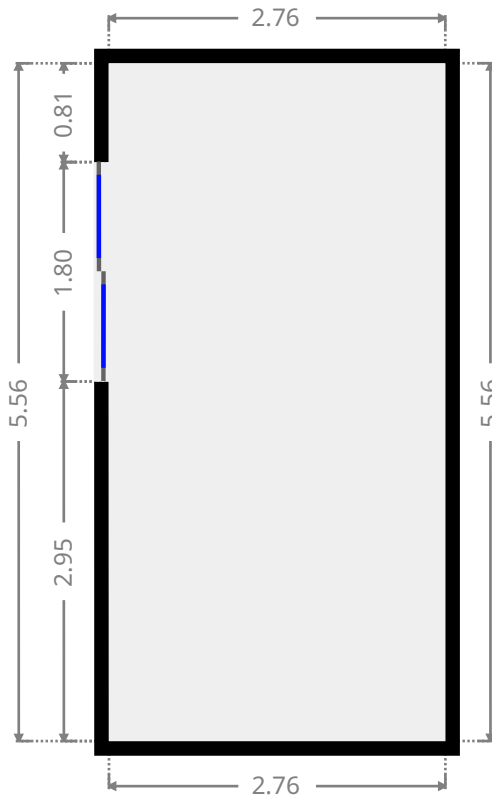
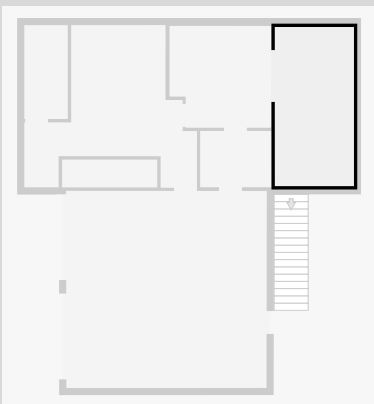

THIS FLOORPLAN IS PROVIDED WITHOUT WARRANTY OF ANY KIND. SENSOPIA DISCLAIMS ANY WARRANTY INCLUDING, WITHOUT LIMITATION, SATISFACTORY QUALITY OR ACCURACY OF DIMENSIONS.

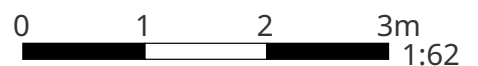

14 Webster Street

Other

Width: 1.52 m
Length: 3.28 m
Area: 4.99 m²
Perimeter: 9.60 m

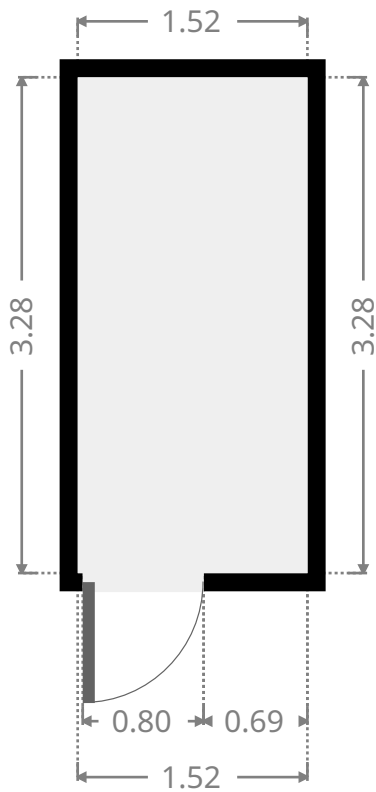
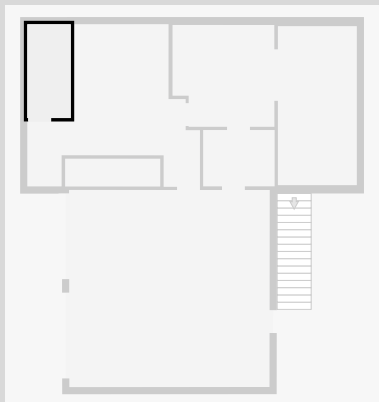

14 Webster Street

1st Floor

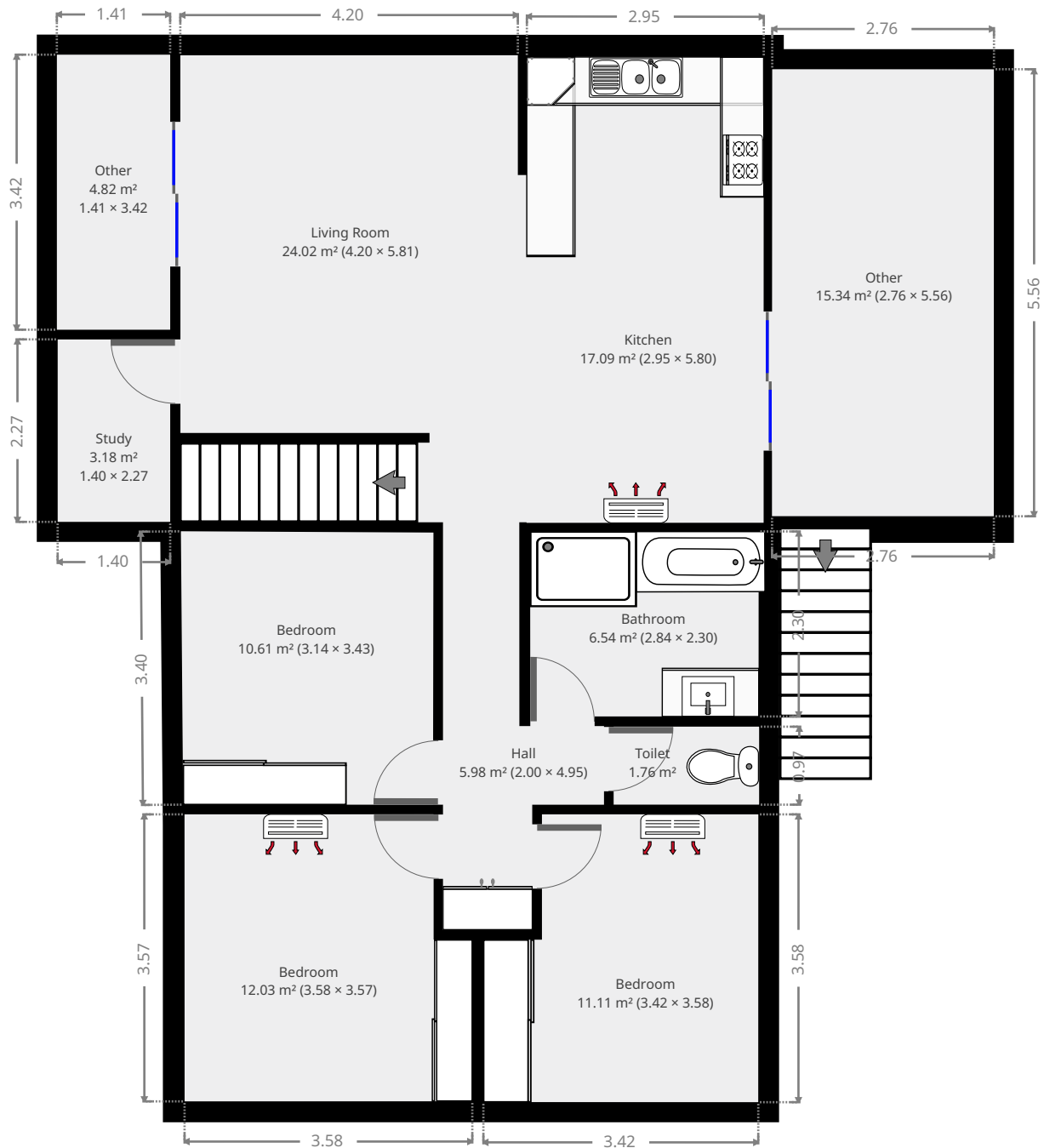

THIS FLOORPLAN IS PROVIDED WITHOUT WARRANTY OF ANY KIND. SENSOPIA DISCLAIMS ANY WARRANTY INCLUDING, WITHOUT LIMITATION, SATISFACTORY QUALITY OR ACCURACY OF DIMENSIONS.



14 Webster Street

Kitchen

Width: 2.95 m
 Length: 5.80 m
 Area: 17.09 m²
 Perimeter: 17.49 m

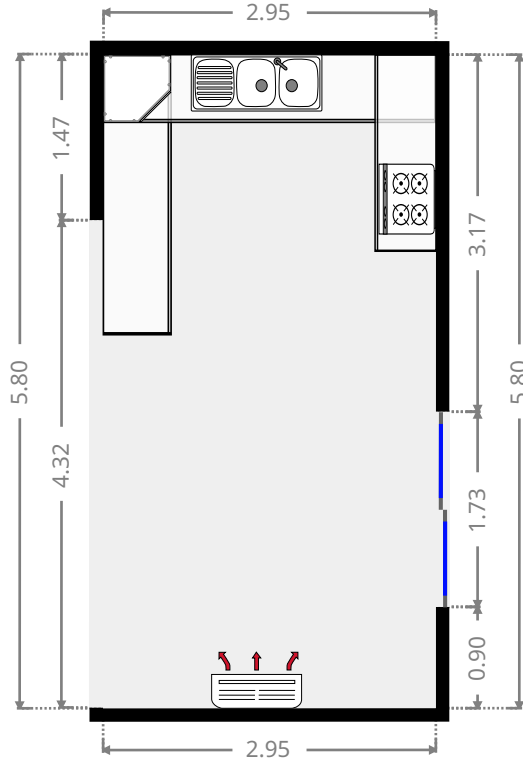
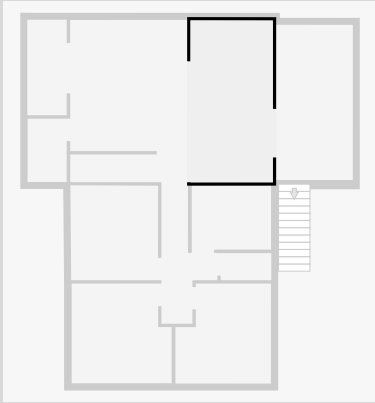

Living Room

Width: 4.20 m
 Length: 5.81 m
 Area: 24.02 m²
 Perimeter: 26.22 m

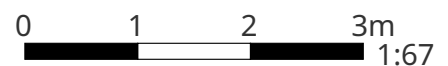
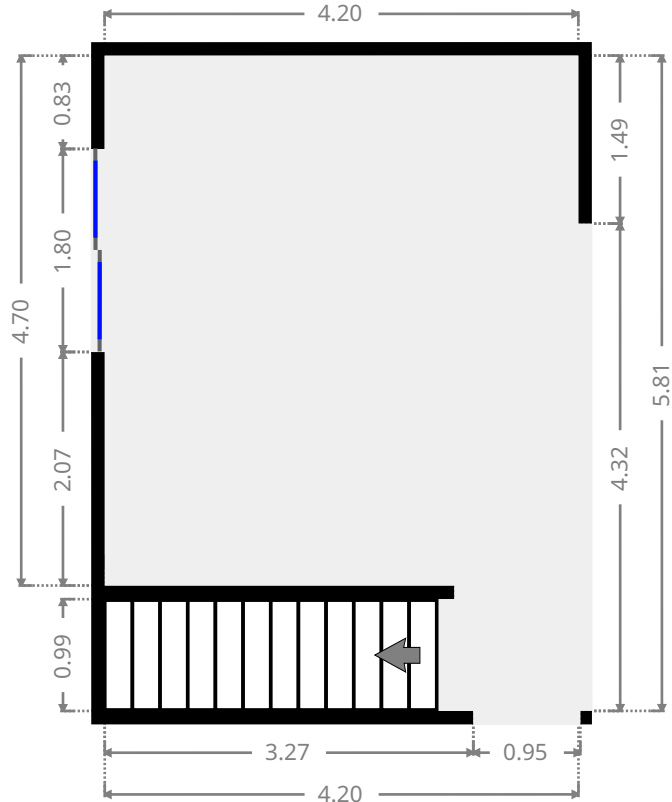
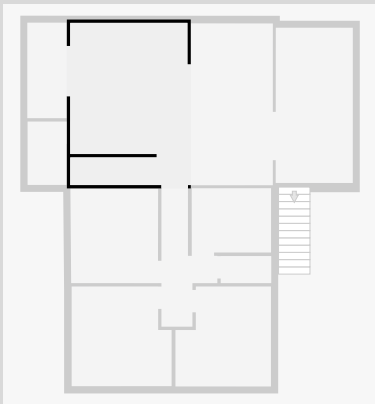

THIS FLOORPLAN IS PROVIDED WITHOUT WARRANTY OF ANY KIND. SENSOPIA DISCLAIMS ANY WARRANTY INCLUDING, WITHOUT LIMITATION, SATISFACTORY QUALITY OR ACCURACY OF DIMENSIONS.

14 Webster Street

Study

Width: 1.40 m
Length: 2.27 m
Area: 3.18 m²
Perimeter: 7.34 m

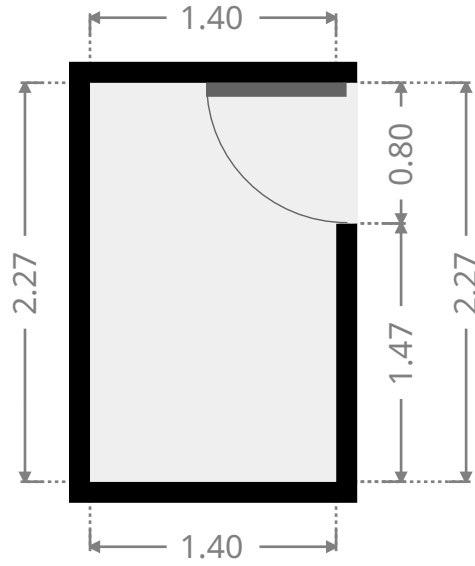
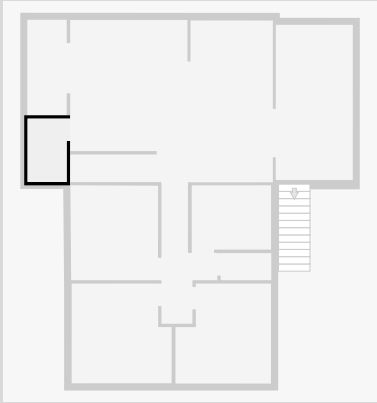

Other

Width: 1.41 m
Length: 3.42 m
Area: 4.82 m²
Perimeter: 9.66 m

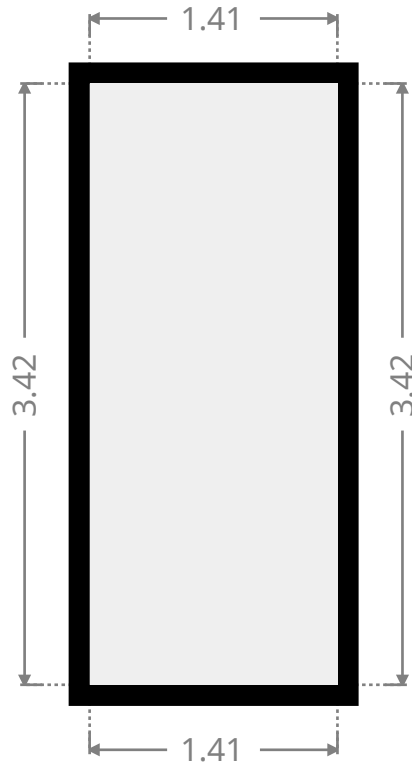
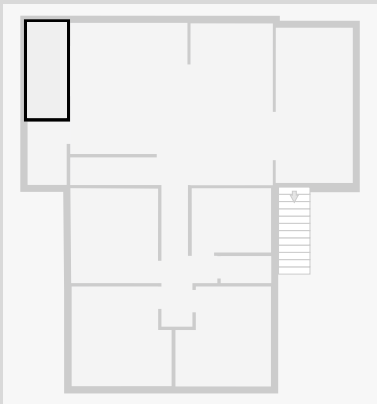

14 Webster Street

Hall

Width: 2.00 m
 Length: 4.95 m
 Area: 5.98 m²
 Perimeter: 13.90 m

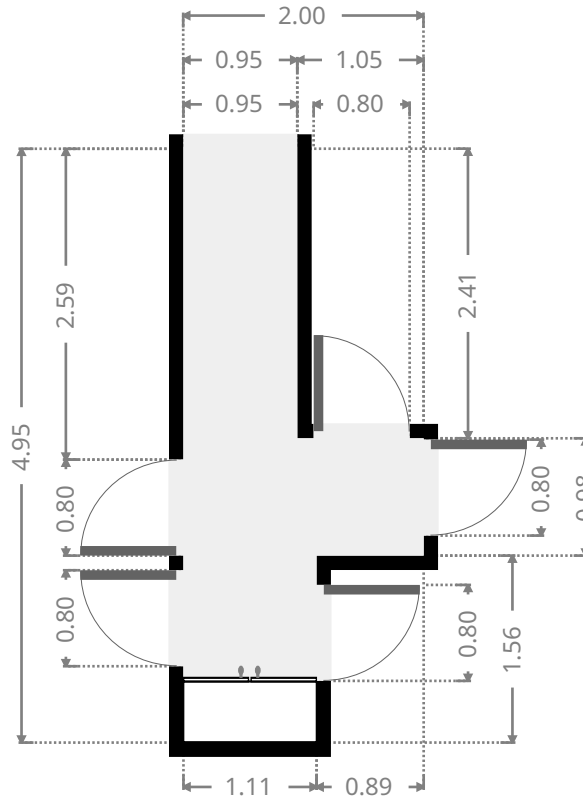
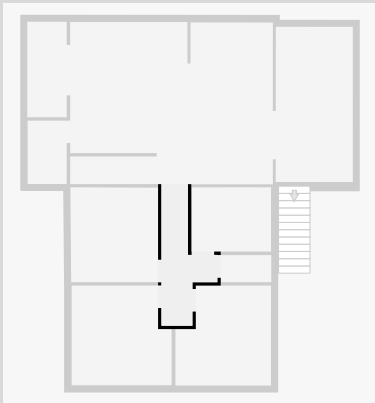

Bathroom

Width: 2.30 m
 Length: 2.84 m
 Area: 6.54 m²
 Perimeter: 10.28 m

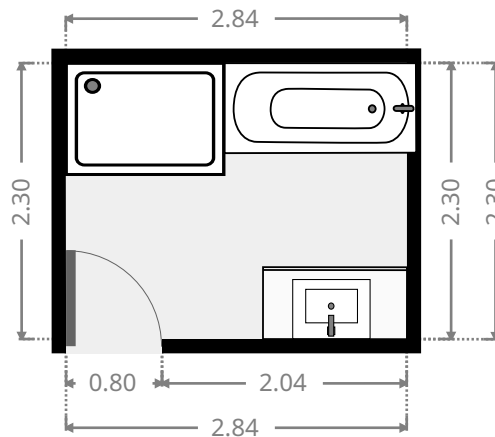
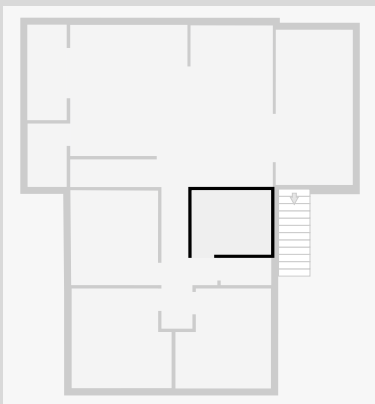

14 Webster Street

Toilet / Half Bath

Width: 0.97 m
Length: 1.81 m
Area: 1.76 m²
Perimeter: 5.56 m

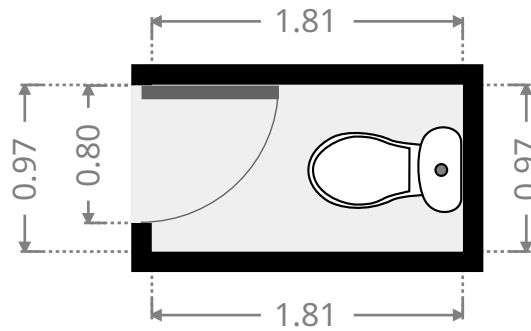
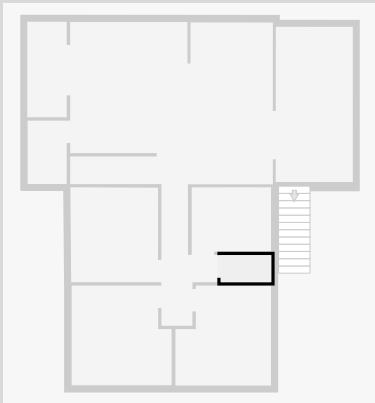

Bedroom

Width: 3.42 m
Length: 3.58 m
Area: 11.11 m²
Perimeter: 14.00 m

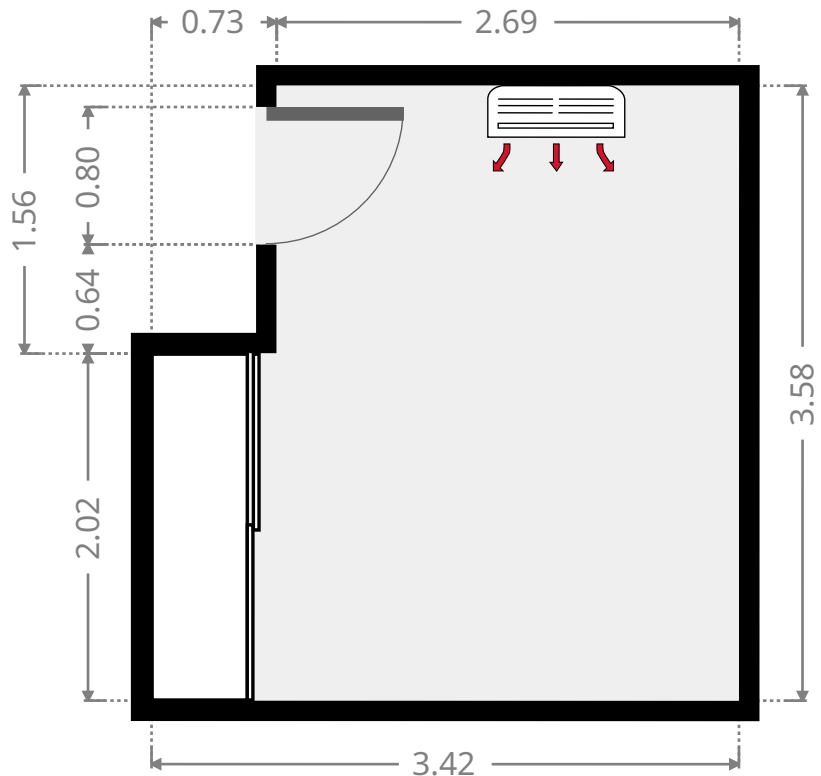
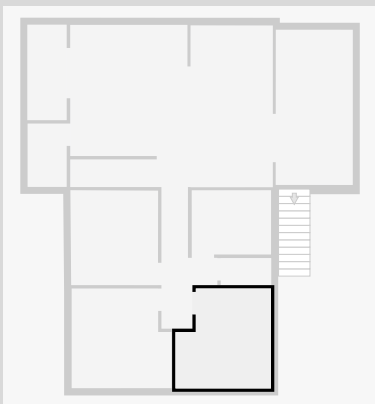

THIS FLOORPLAN IS PROVIDED WITHOUT WARRANTY OF ANY KIND. SENSOPIA DISCLAIMS ANY WARRANTY INCLUDING, WITHOUT LIMITATION, SATISFACTORY QUALITY OR ACCURACY OF DIMENSIONS.

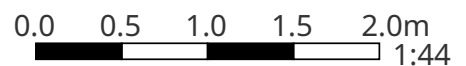

14 Webster Street

Bedroom

Width: 3.57 m
 Length: 3.58 m
 Area: 12.03 m²
 Perimeter: 14.30 m

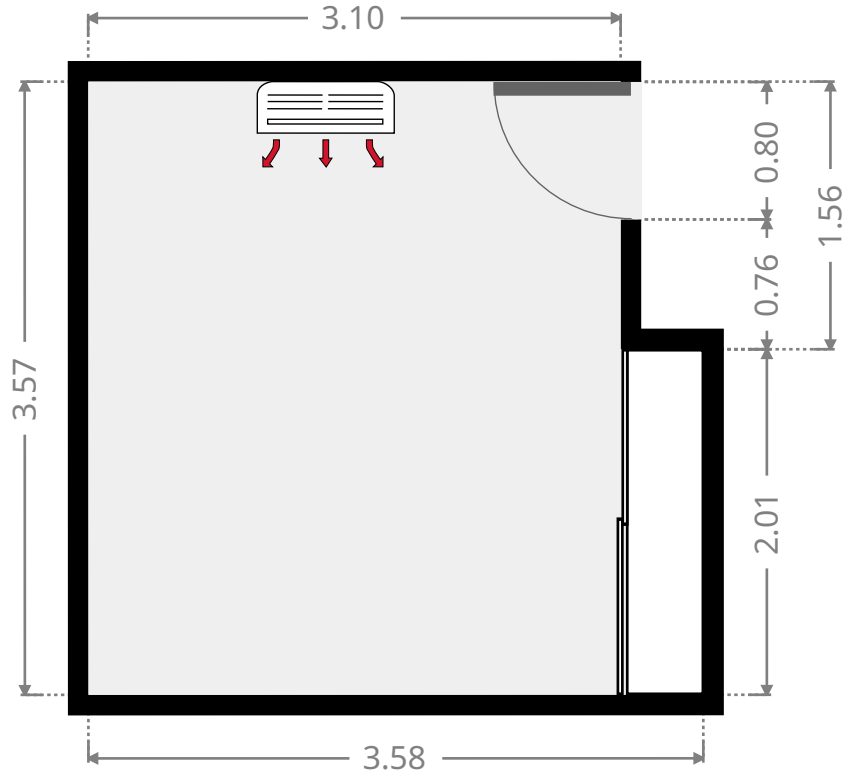
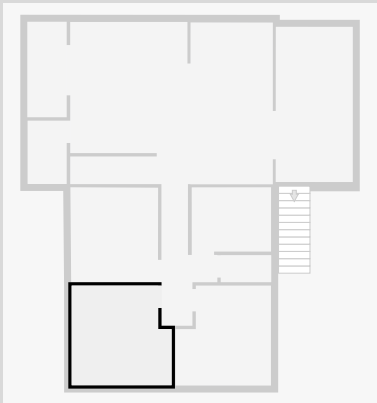

Bedroom

Width: 3.14 m
 Length: 3.43 m
 Area: 10.61 m²
 Perimeter: 13.04 m

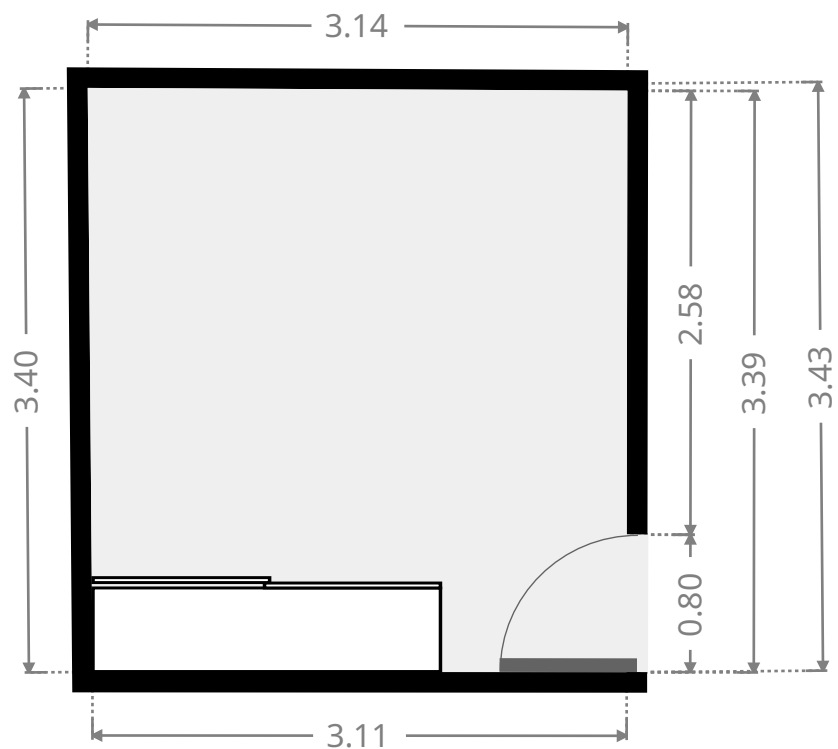
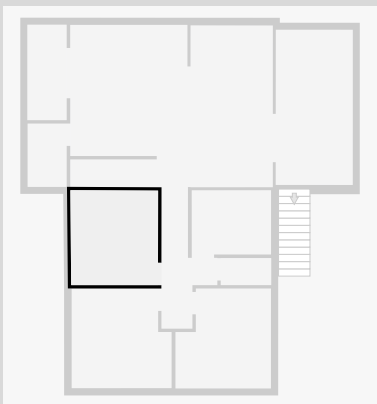

THIS FLOORPLAN IS PROVIDED WITHOUT WARRANTY OF ANY KIND. SENSOPIA DISCLAIMS ANY WARRANTY INCLUDING, WITHOUT LIMITATION, SATISFACTORY QUALITY OR ACCURACY OF DIMENSIONS.

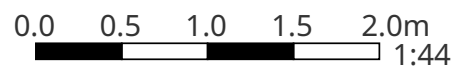

14 Webster Street

Other

Width: 2.76 m
Length: 5.56 m
Area: 15.34 m²
Perimeter: 16.64 m

