

14 Tawarra Crescent

Ground Floor

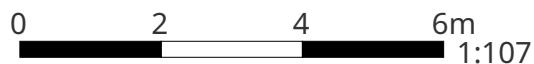

THIS FLOORPLAN IS PROVIDED WITHOUT WARRANTY OF ANY KIND. SENSOPIA DISCLAIMS ANY WARRANTY INCLUDING, WITHOUT LIMITATION, SATISFACTORY QUALITY OR ACCURACY OF DIMENSIONS.



14 Tawarra Crescent

Hall

Width: 1.99 m
 Length: 5.40 m
 Area: 8.84 m²
 Perimeter: 14.78 m

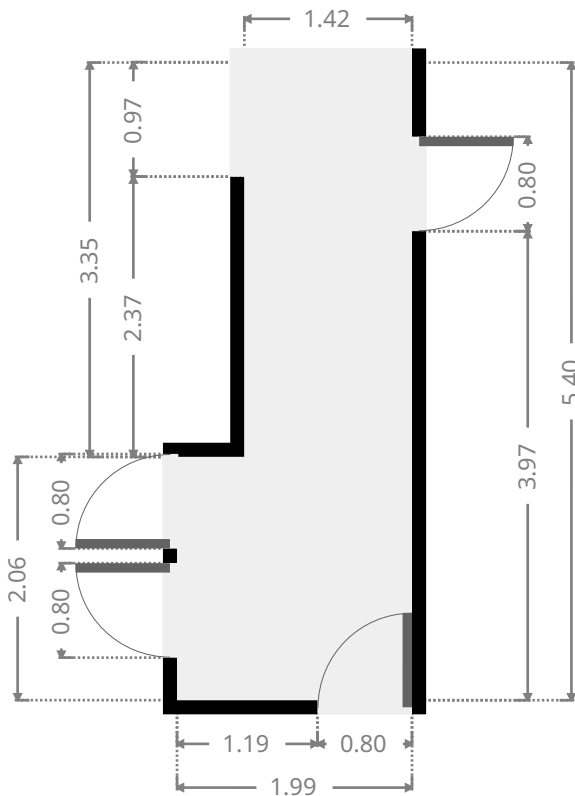
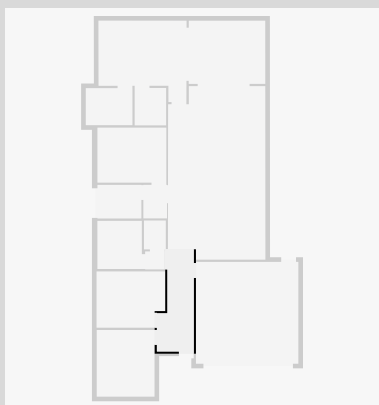

Bedroom

Width: 3.12 m
 Length: 3.60 m
 Area: 11.23 m²
 Perimeter: 13.44 m

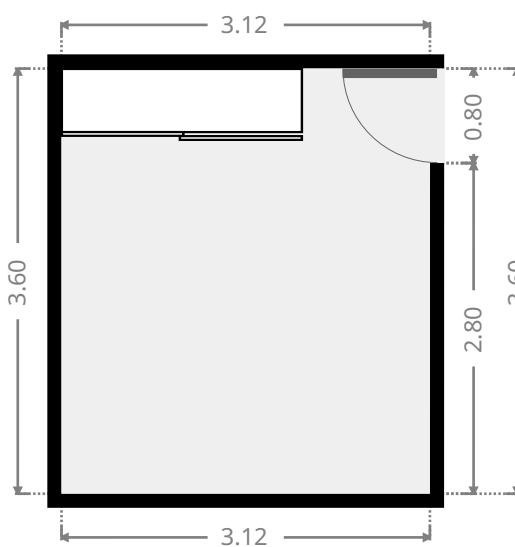
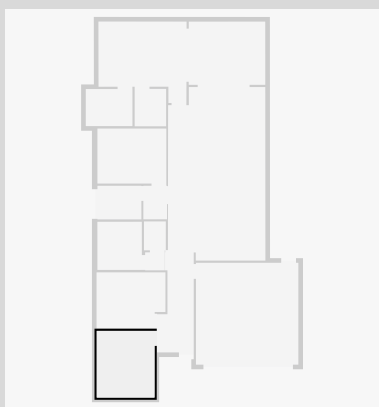

14 Tawarra Crescent

Bedroom

Width: 3.04 m
 Length: 3.72 m
 Area: 10.78 m²
 Perimeter: 13.51 m

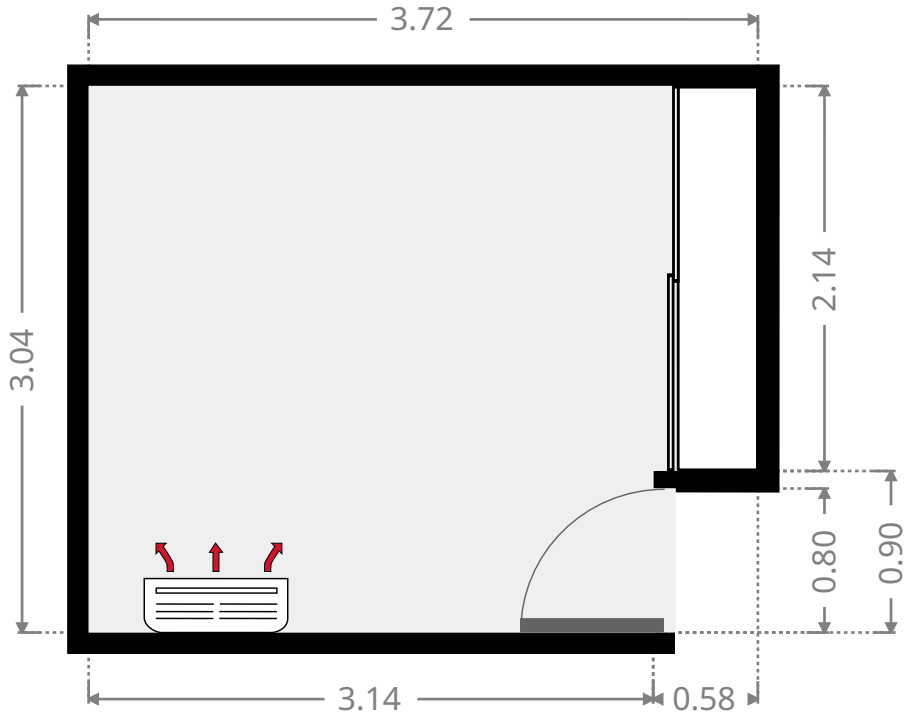
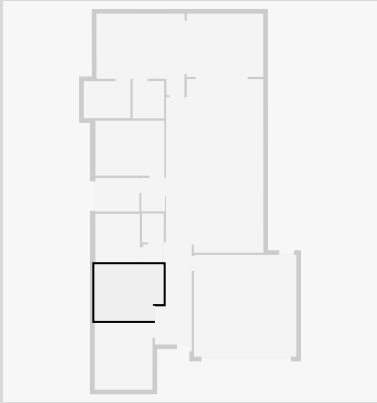

Hall

Width: 0.97 m
 Length: 1.06 m
 Area: 1.03 m²
 Perimeter: 4.06 m

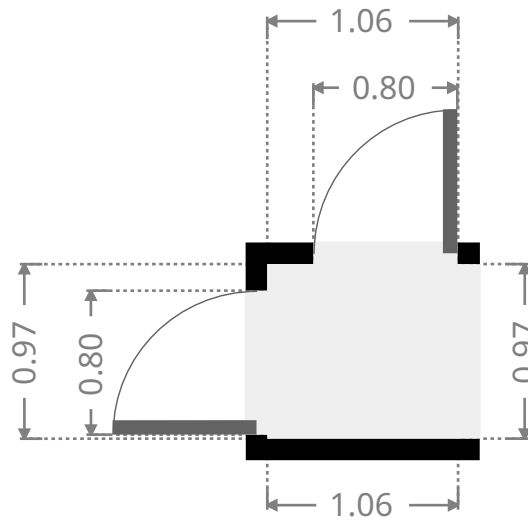

THIS FLOORPLAN IS PROVIDED WITHOUT WARRANTY OF ANY KIND. SENSOPIA DISCLAIMS ANY WARRANTY INCLUDING, WITHOUT LIMITATION, SATISFACTORY QUALITY OR ACCURACY OF DIMENSIONS.

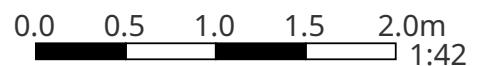

14 Tawarra Crescent

Bathroom

Width: 2.40 m
Length: 2.60 m
Area: 6.24 m²
Perimeter: 10.00 m

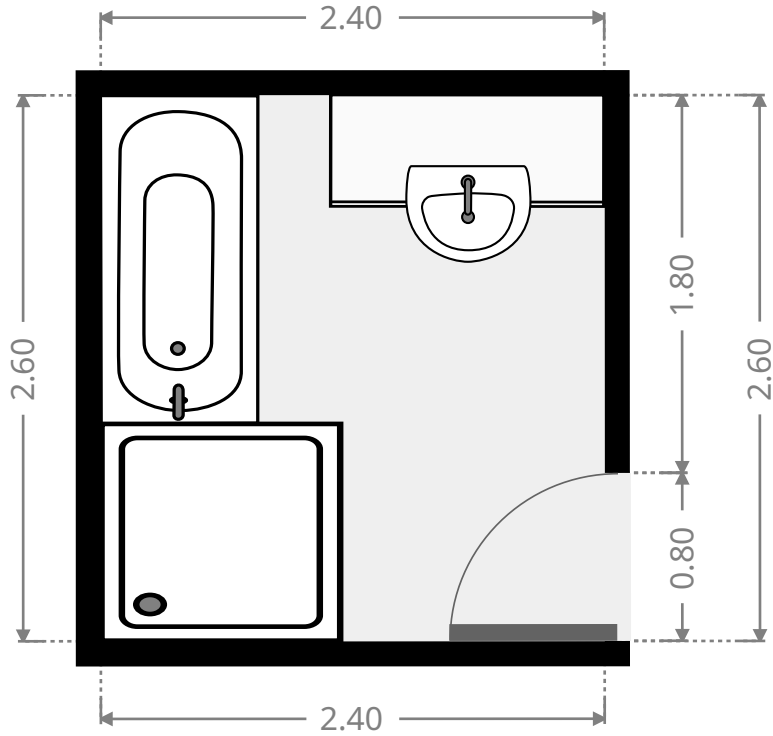
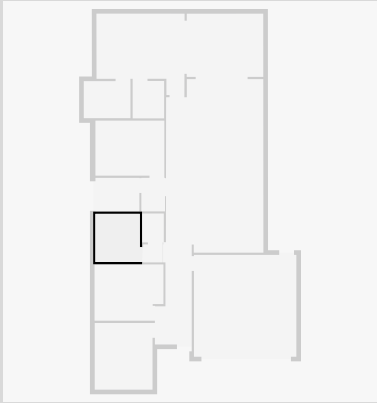

Toilet / Half Bath

Width: 1.18 m
Length: 1.56 m
Area: 1.84 m²
Perimeter: 5.48 m

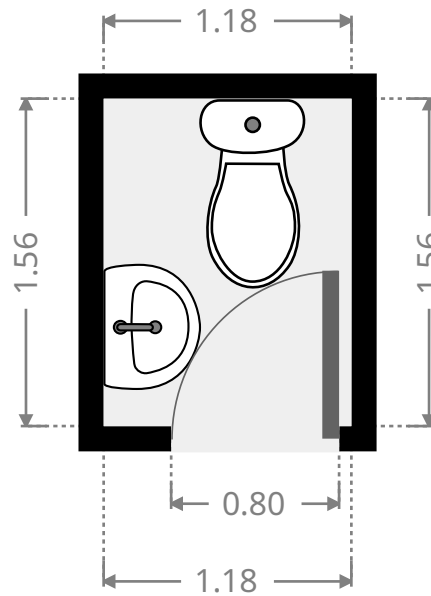
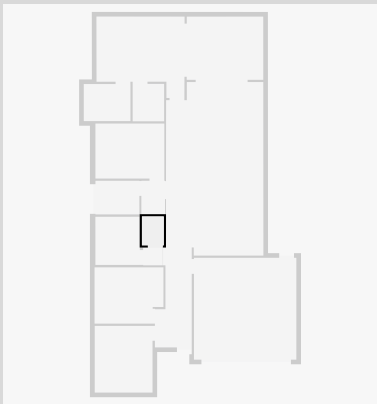

THIS FLOORPLAN IS PROVIDED WITHOUT WARRANTY OF ANY KIND. SENSOPIA DISCLAIMS ANY WARRANTY INCLUDING, WITHOUT LIMITATION, SATISFACTORY QUALITY OR ACCURACY OF DIMENSIONS.

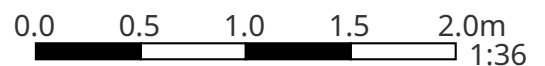

14 Tawarra Crescent

Kitchen

Width: 5.27 m
Length: 9.37 m
Area: 47.32 m²
Perimeter: 29.25 m

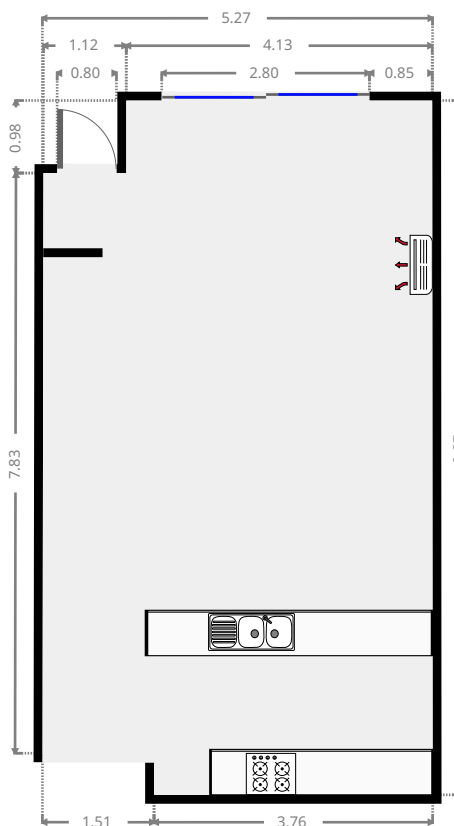
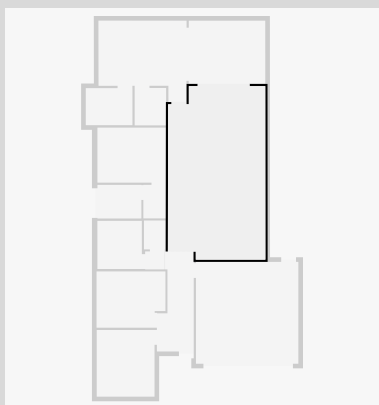

Hall

Width: 1.28 m
Length: 1.81 m
Area: 2.31 m²
Perimeter: 6.18 m

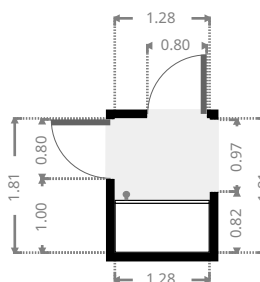
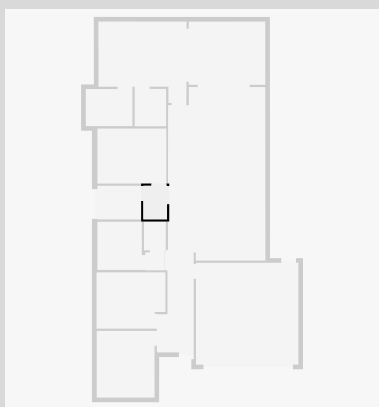

THIS FLOORPLAN IS PROVIDED WITHOUT WARRANTY OF ANY KIND. SENSOPIA DISCLAIMS ANY WARRANTY INCLUDING, WITHOUT LIMITATION, SATISFACTORY QUALITY OR ACCURACY OF DIMENSIONS.

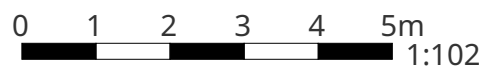

14 Tawarra Crescent

Laundry Room

Width: 1.82 m
 Length: 2.37 m
 Area: 4.31 m²
 Perimeter: 8.38 m

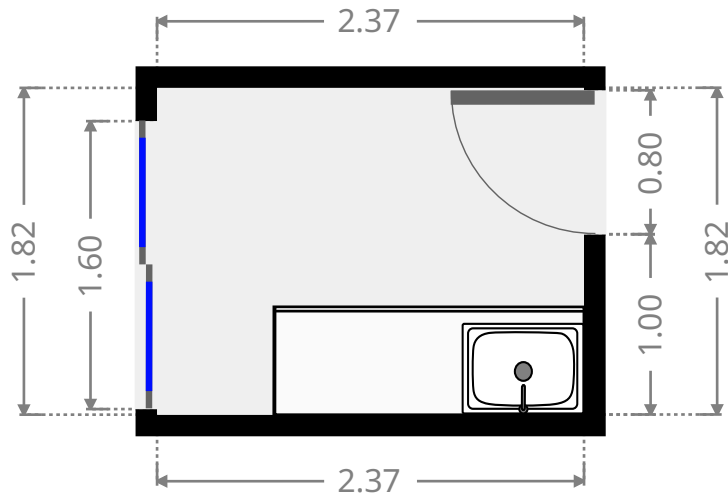
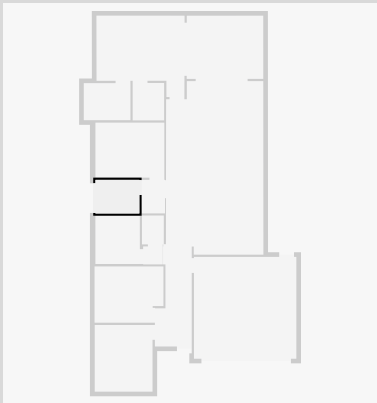

Bedroom

Width: 2.97 m
 Length: 3.72 m
 Area: 11.05 m²
 Perimeter: 13.38 m

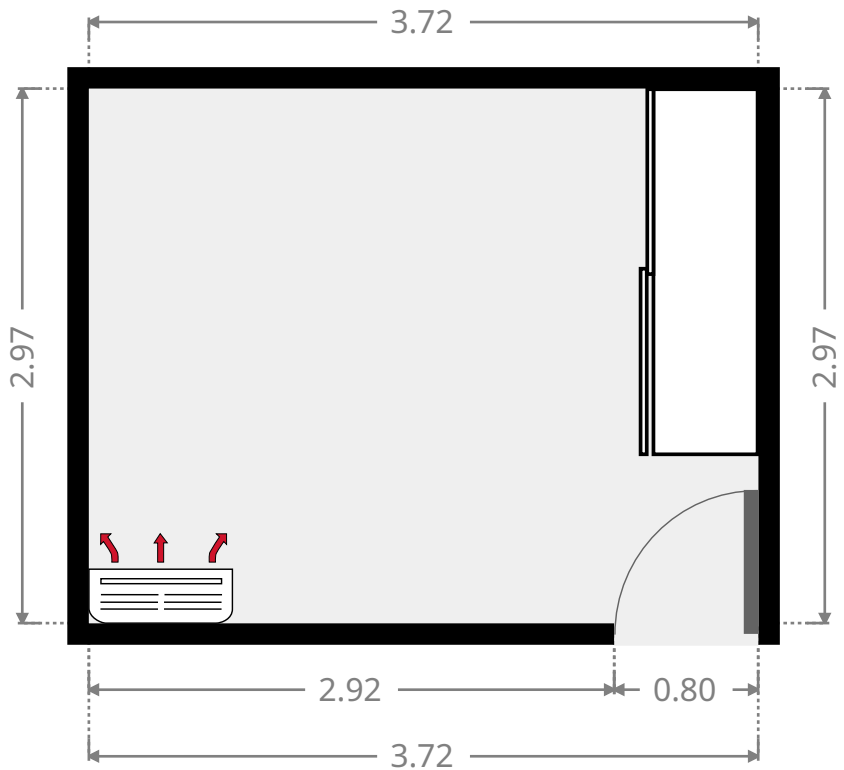
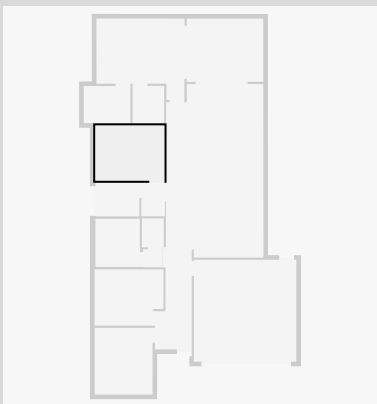

THIS FLOORPLAN IS PROVIDED WITHOUT WARRANTY OF ANY KIND. SENSOPIA DISCLAIMS ANY WARRANTY INCLUDING, WITHOUT LIMITATION, SATISFACTORY QUALITY OR ACCURACY OF DIMENSIONS.

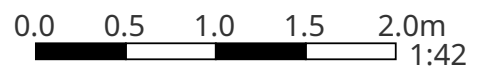

14 Tawarra Crescent

Master Bedroom

Width: 4.40 m
 Length: 4.76 m
 Area: 17.57 m²
 Perimeter: 18.30 m

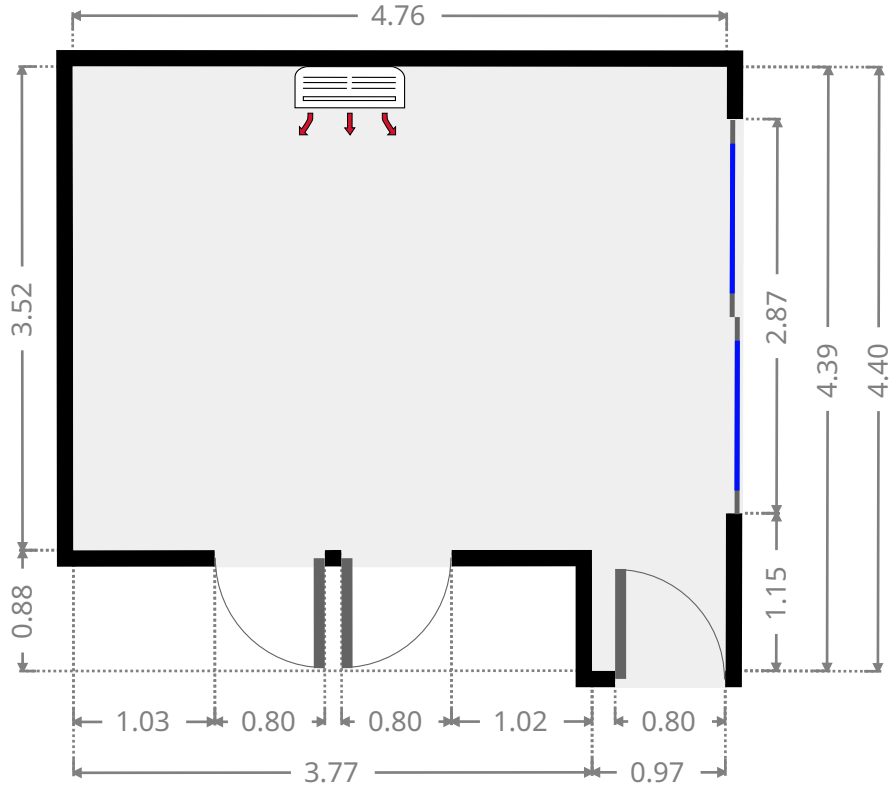
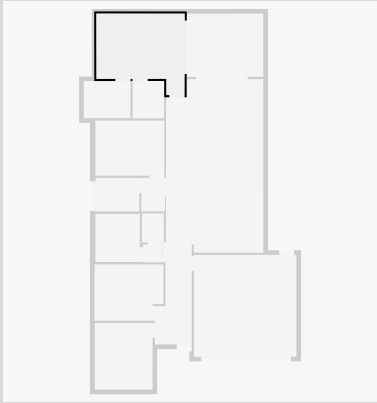

Closet

Width: 1.70 m
 Length: 2.02 m
 Area: 3.44 m²
 Perimeter: 7.44 m

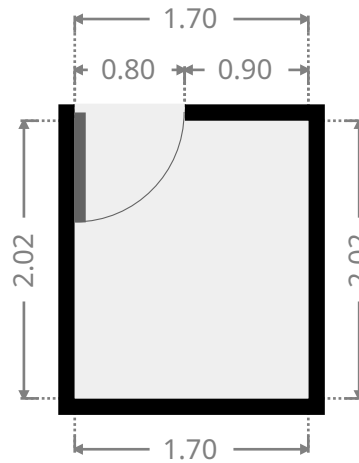

THIS FLOORPLAN IS PROVIDED WITHOUT WARRANTY OF ANY KIND. SENSOPIA DISCLAIMS ANY WARRANTY INCLUDING, WITHOUT LIMITATION, SATISFACTORY QUALITY OR ACCURACY OF DIMENSIONS.

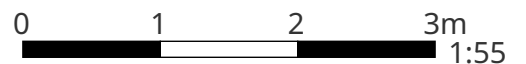

14 Tawarra Crescent

Bathroom

Width: 2.00 m
 Length: 2.52 m
 Area: 5.04 m²
 Perimeter: 9.04 m

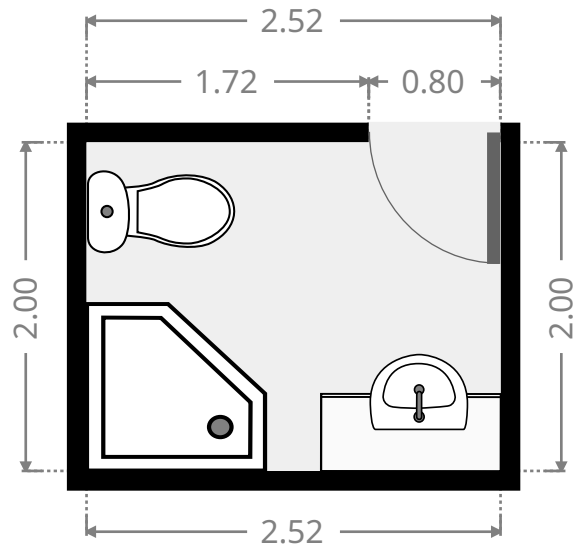
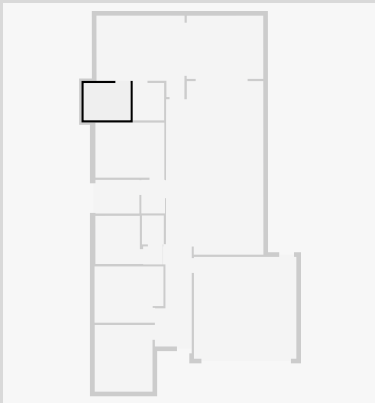

Other

Width: 3.41 m
 Length: 4.14 m
 Area: 14.11 m²
 Perimeter: 15.09 m

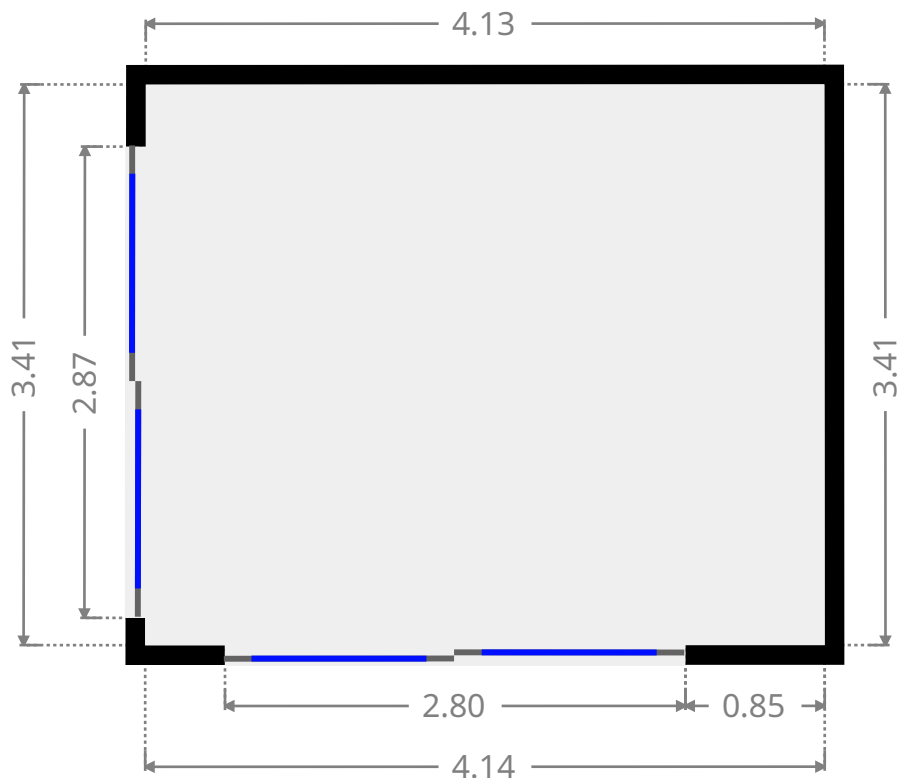
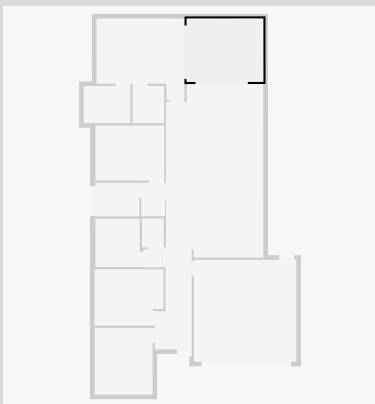

THIS FLOORPLAN IS PROVIDED WITHOUT WARRANTY OF ANY KIND. SENSOPIA DISCLAIMS ANY WARRANTY INCLUDING, WITHOUT LIMITATION, SATISFACTORY QUALITY OR ACCURACY OF DIMENSIONS.

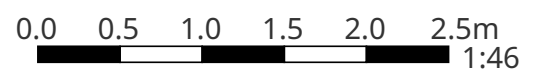

14 Tawarra Crescent

Garage

Width: 5.50 m
Length: 5.53 m
Area: 30.41 m²
Perimeter: 22.06 m

