

14 Stoneybrook Court

SUBMITTED BY

Ray White Rockhampton Casey
stockers@cqoz.com

CREATED ON

2022-08-29

Floors

2

▼ Ground Floor

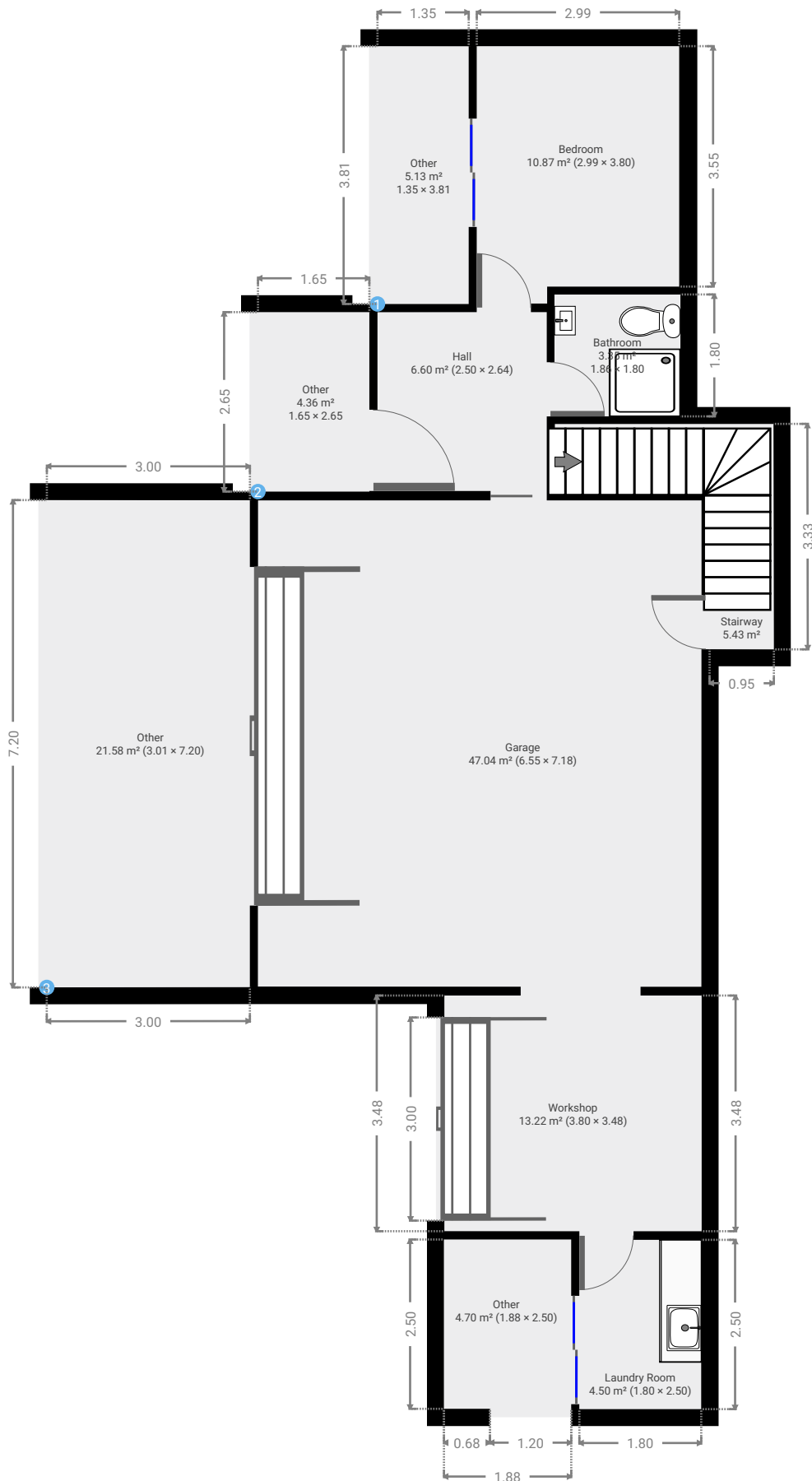

▼ Bathroom Ground Floor

WIDTH: 1.80 m • LENGTH: 1.86 m
AREA: 3.35 m² • PERIMETER: 7.32 m

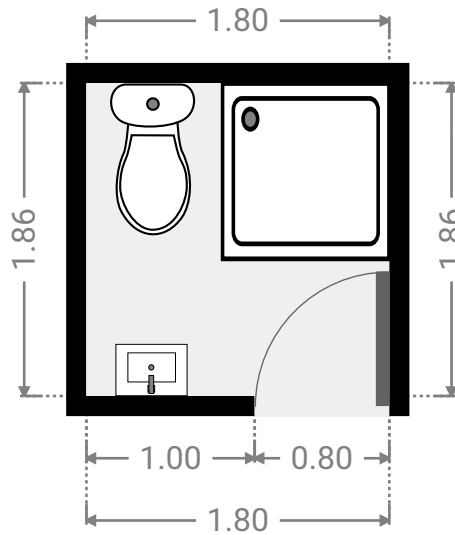
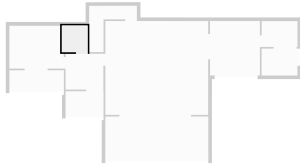

▼ Bedroom Ground Floor

WIDTH: 3.80 m • LENGTH: 2.99 m
AREA: 10.87 m² • PERIMETER: 13.58 m

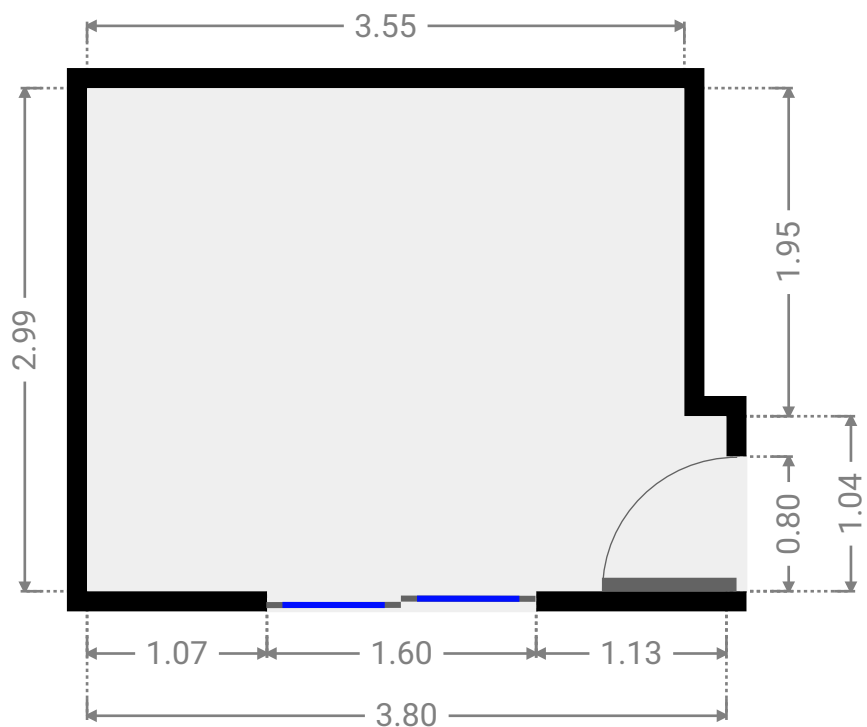

▼ Garage Ground Floor

WIDTH: 7.18 m • LENGTH: 6.55 m
AREA: 47.04 m² • PERIMETER: 27.46 m

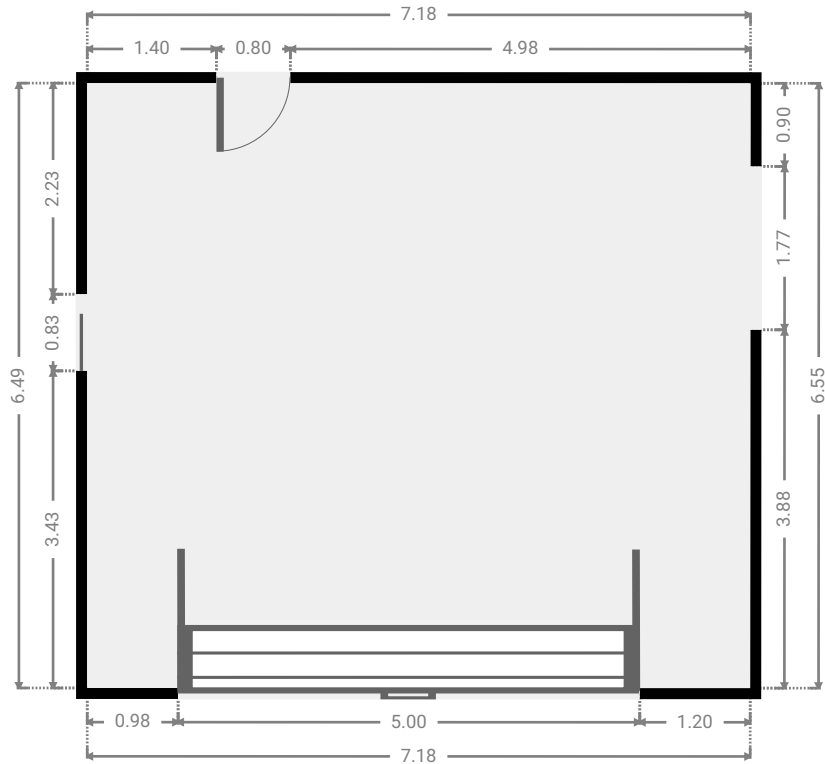
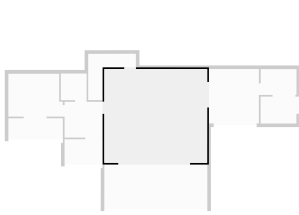

▼ Hall Ground Floor

WIDTH: 2.64 m • LENGTH: 2.50 m
AREA: 6.60 m² • PERIMETER: 10.28 m

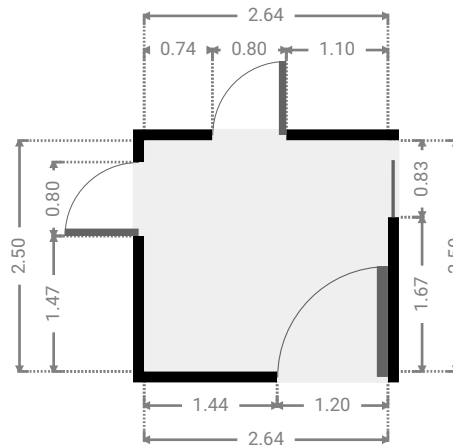
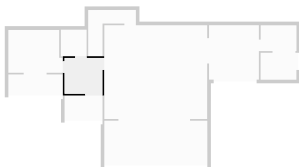

FLOORS: 2

▼ Laundry Room
Ground Floor

WIDTH: 2.50 m • LENGTH: 1.80 m
AREA: 4.50 m² • PERIMETER: 8.60 m

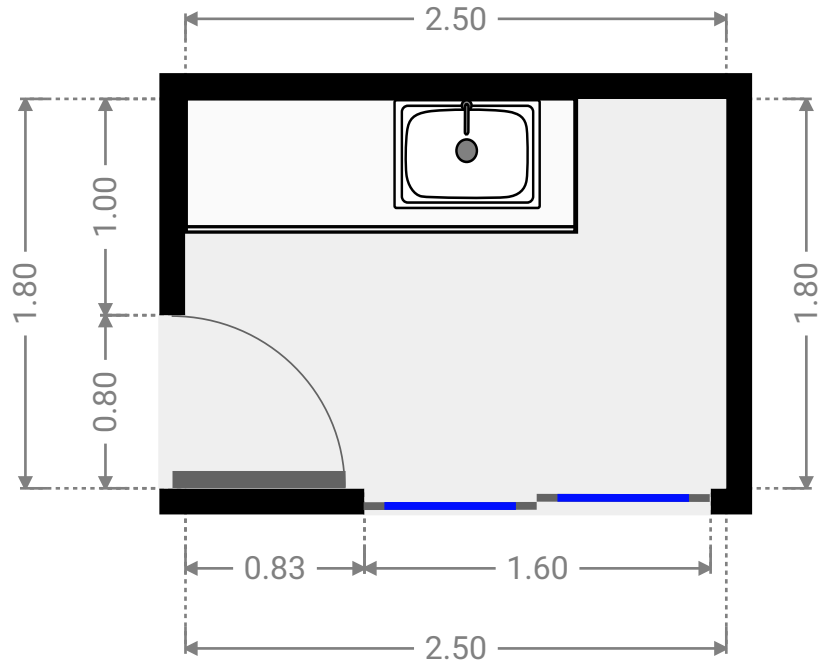
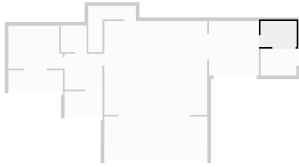

▼ Other
Ground Floor

WIDTH: 2.50 m • LENGTH: 1.88 m
AREA: 4.70 m² • PERIMETER: 8.76 m

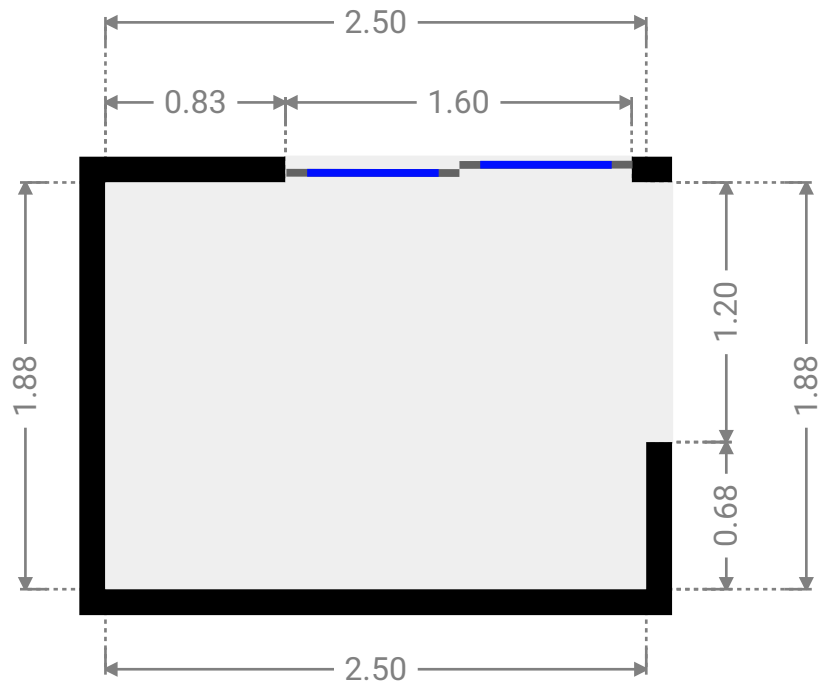

▼ **Other**
Ground Floor

WIDTH: 3.81 m • LENGTH: 1.35 m
AREA: 5.13 m² • PERIMETER: 10.31 m

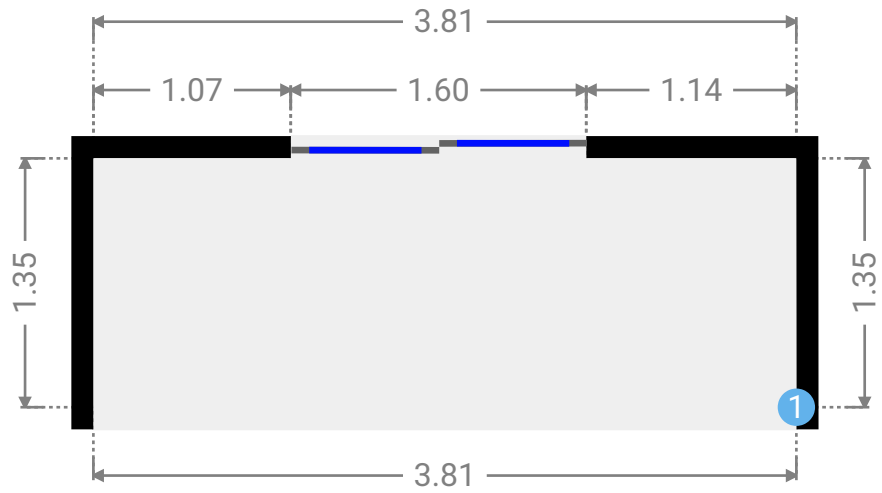
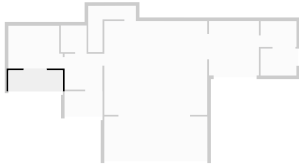

▼ **Other/Ground Floor**

1 OPENING

Height
0.00 m



FLOORS: 2

▼ Other Ground Floor

WIDTH: 2.65 m • LENGTH: 1.65 m
AREA: 4.36 m² • PERIMETER: 8.59 m

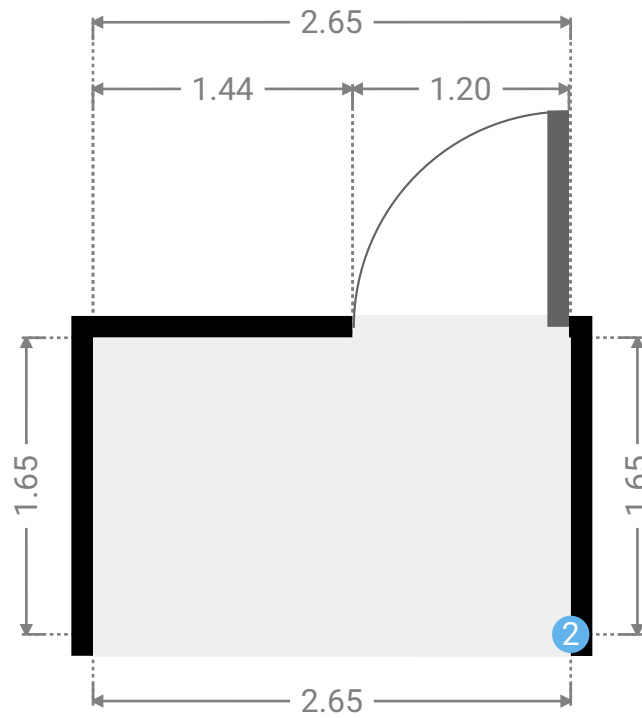
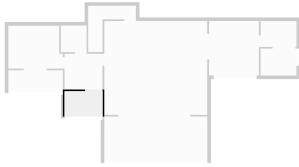

▼ Other/Ground Floor

2 OPENING

Height
0.00 m



▼ Other Ground Floor

WIDTH: 7.20 m • LENGTH: 3.01 m
AREA: 21.58 m² • PERIMETER: 20.39 m

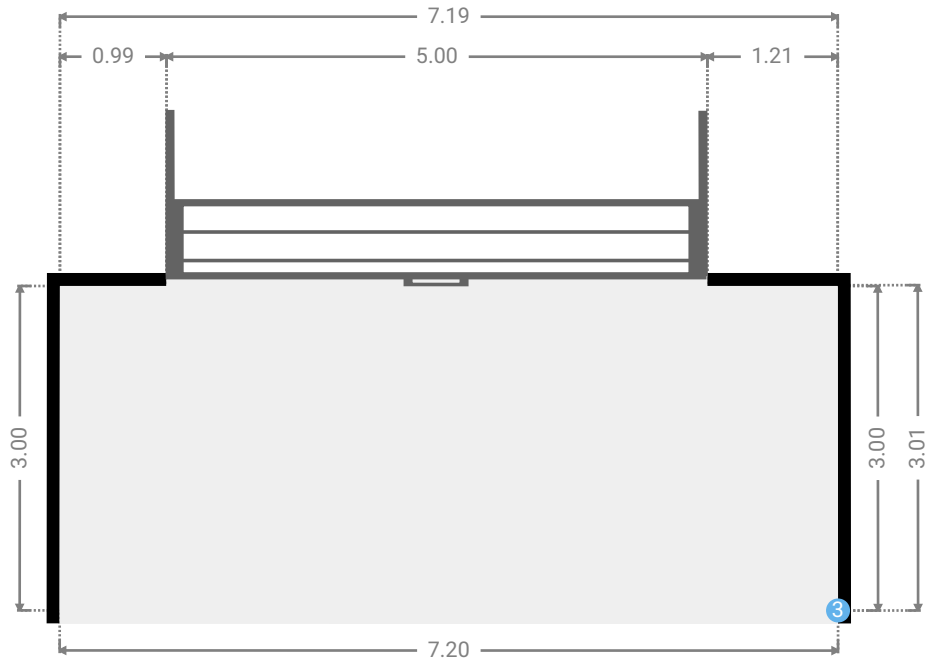
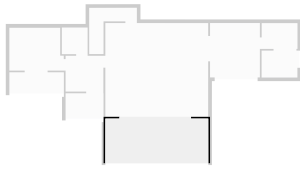

▼ Other/Ground Floor

3 OPENING

Height
0.00 m



FLOORS: 2

▼ Stairway Ground Floor

WIDTH: 3.33 m • LENGTH: 3.24 m
AREA: 5.43 m² • PERIMETER: 13.12 m

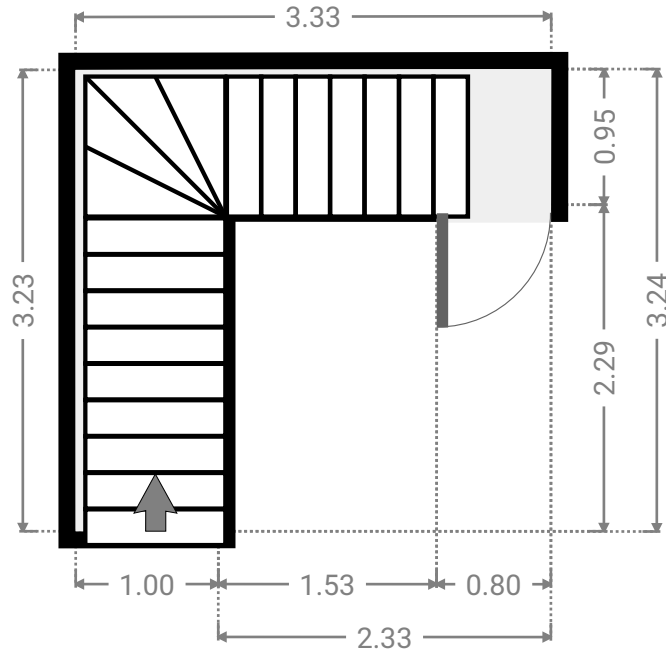
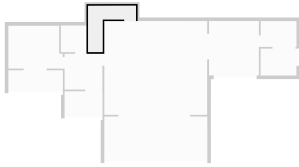

▼ Workshop Ground Floor

WIDTH: 3.48 m • LENGTH: 3.80 m
AREA: 13.22 m² • PERIMETER: 14.56 m

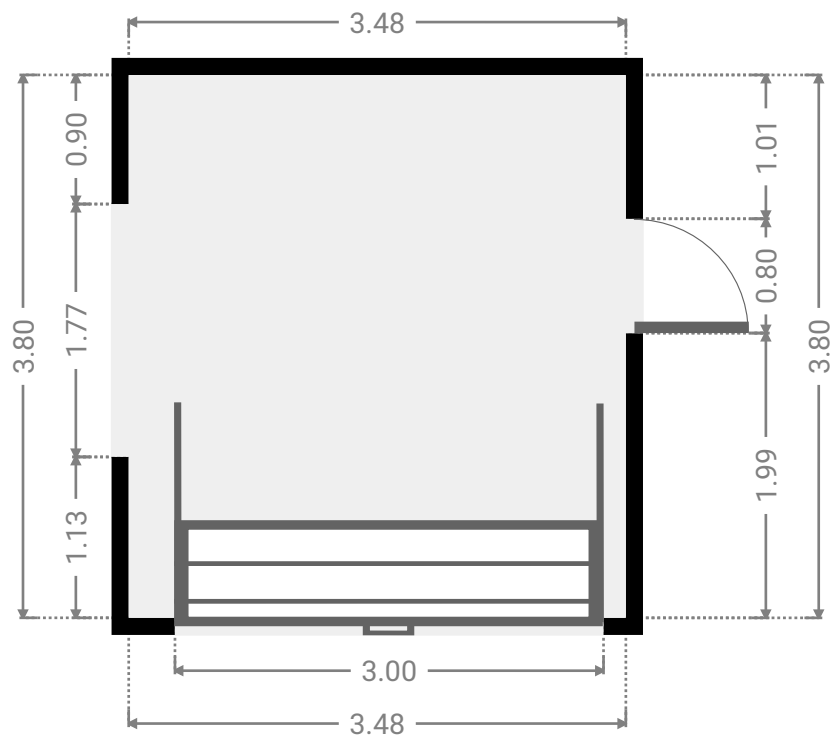

▼ 1st Floor

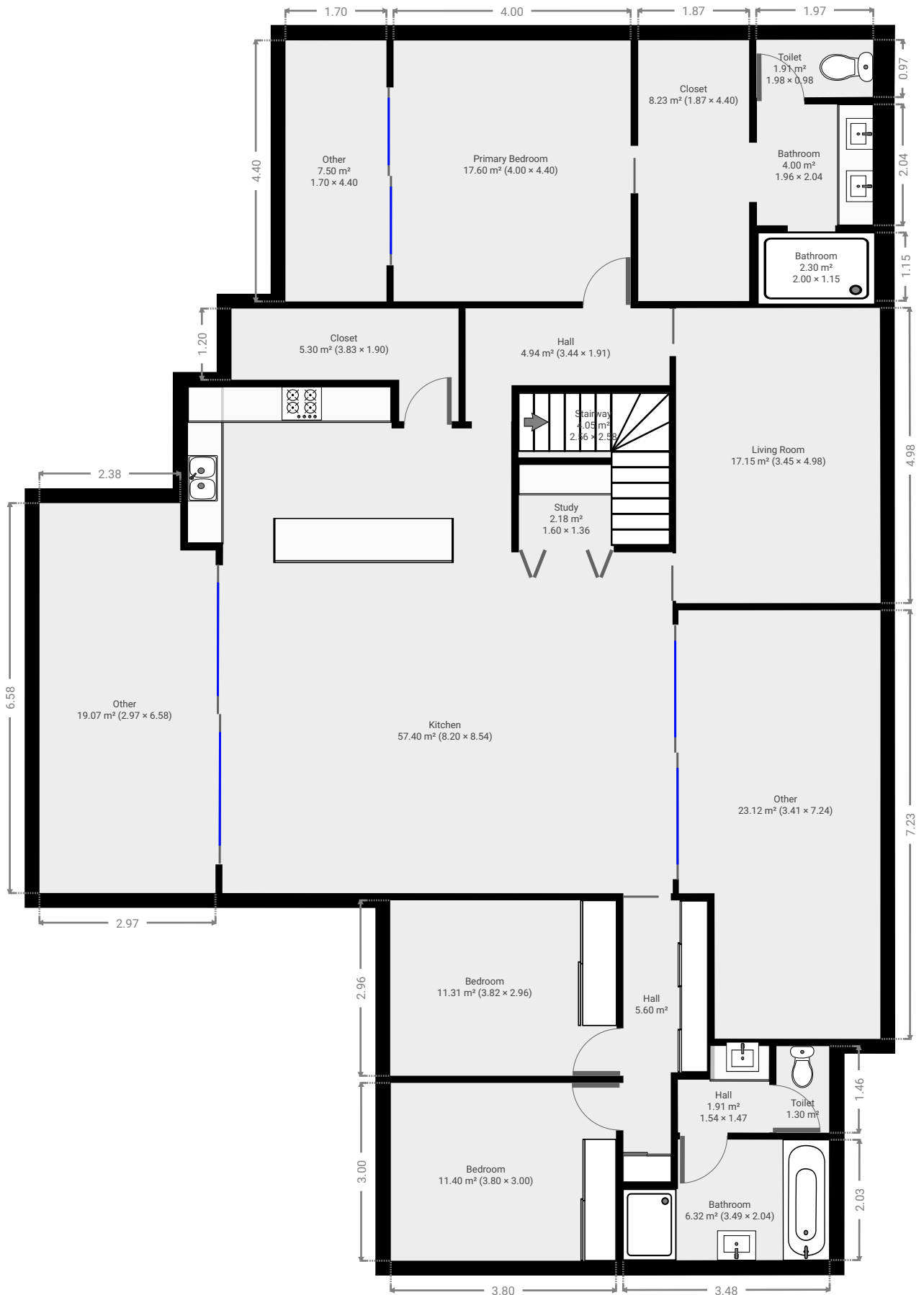

THIS FLOORPLAN IS PROVIDED WITHOUT WARRANTY OF ANY KIND. SENSOPIA DISCLAIMS ANY WARRANTY INCLUDING, WITHOUT LIMITATION, SATISFACTORY QUALITY OR ACCURACY OF DIMENSIONS.

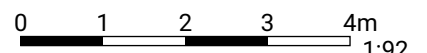

▼ **Bathroom**
1st Floor

WIDTH: 1.15 m • LENGTH: 2.00 m
AREA: 2.30 m² • PERIMETER: 6.30 m

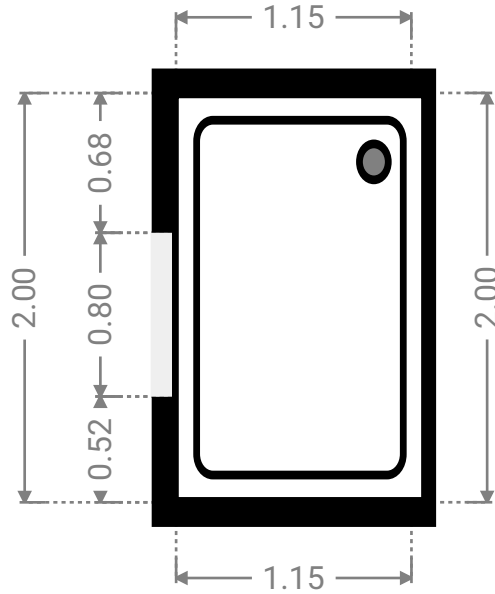
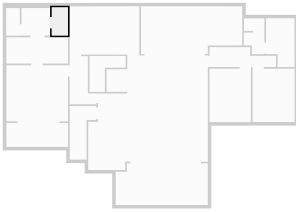

▼ **Bathroom**
1st Floor

WIDTH: 2.04 m • LENGTH: 1.96 m
AREA: 4.00 m² • PERIMETER: 8.00 m

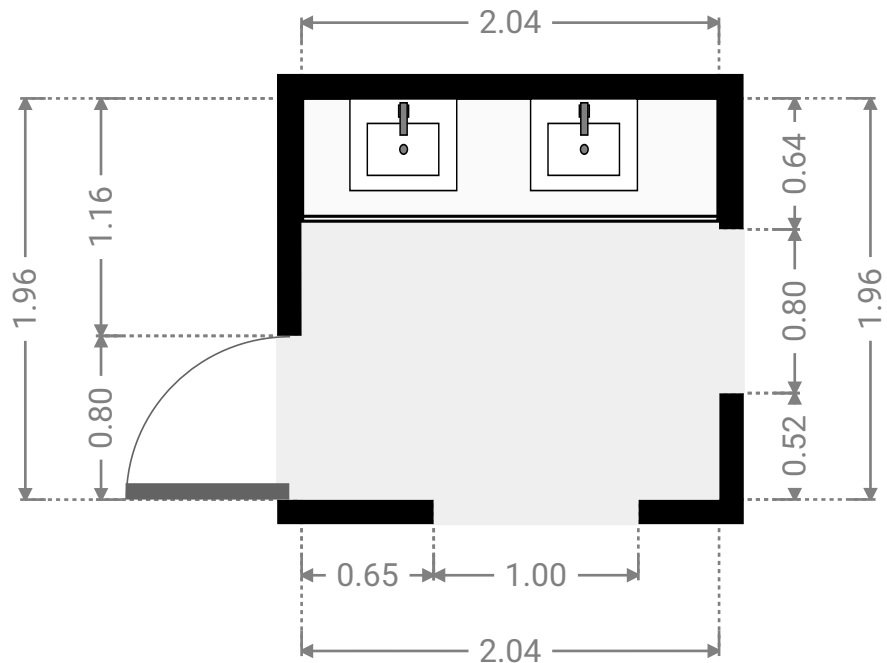
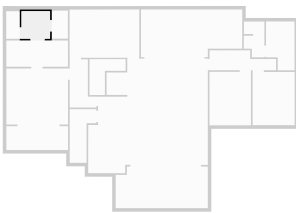

▼ **Bathroom**
1st Floor

WIDTH: 2.04 m • LENGTH: 3.49 m
AREA: 6.32 m² • PERIMETER: 11.04 m

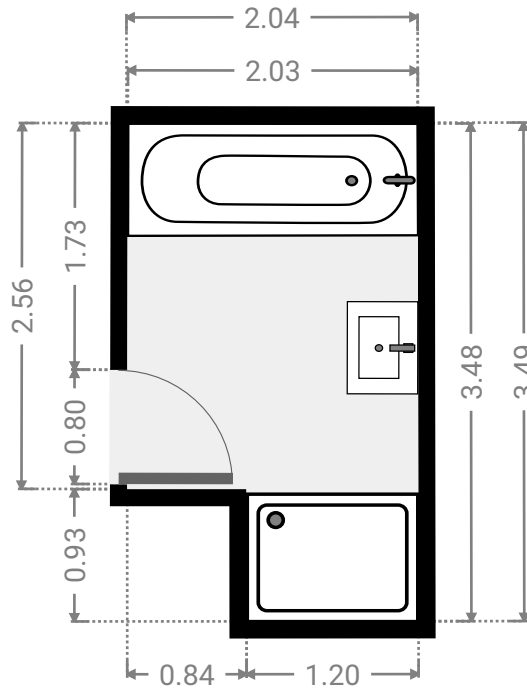
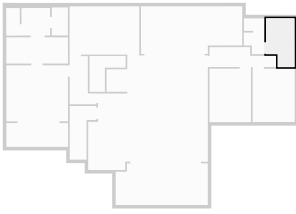

▼ **Bedroom**
1st Floor

WIDTH: 2.96 m • LENGTH: 3.82 m
AREA: 11.31 m² • PERIMETER: 13.56 m

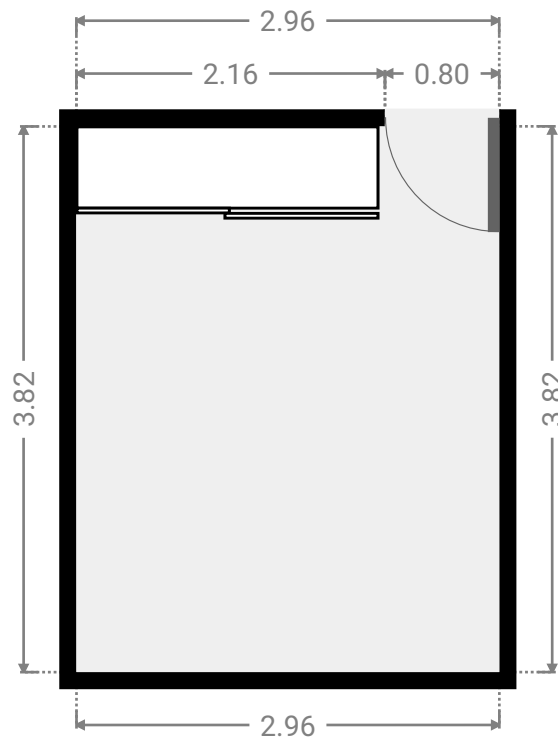
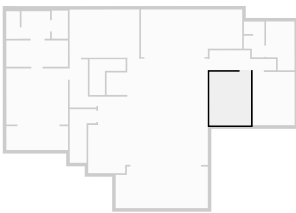

▼ **Bedroom**
1st Floor

WIDTH: 3.00 m • LENGTH: 3.80 m
AREA: 11.40 m² • PERIMETER: 13.60 m

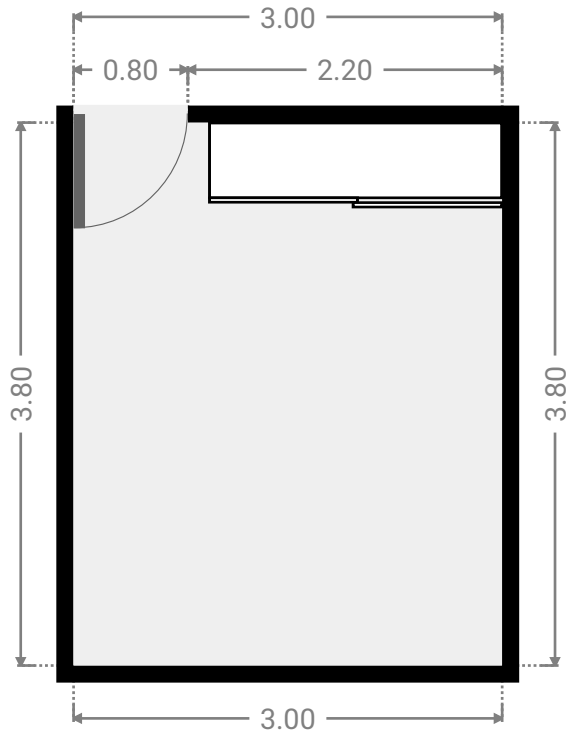
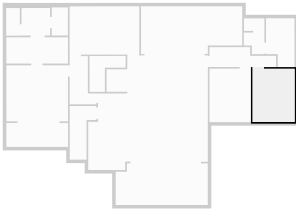

▼ **Closet**
1st Floor

WIDTH: 4.40 m • LENGTH: 1.87 m
AREA: 8.23 m² • PERIMETER: 12.54 m

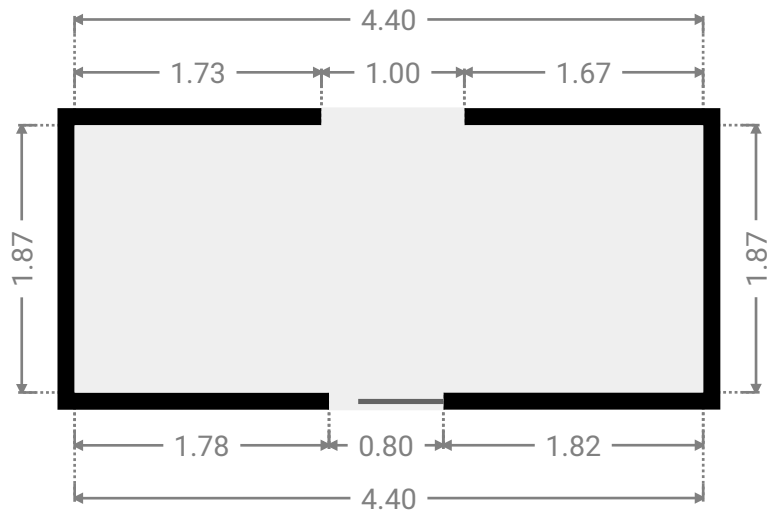
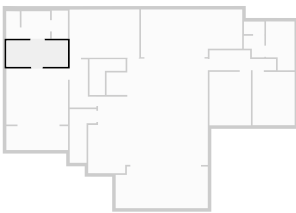

▼ **Hall**
1st Floor

WIDTH: 1.91 m • LENGTH: 3.44 m
AREA: 4.94 m² • PERIMETER: 10.69 m

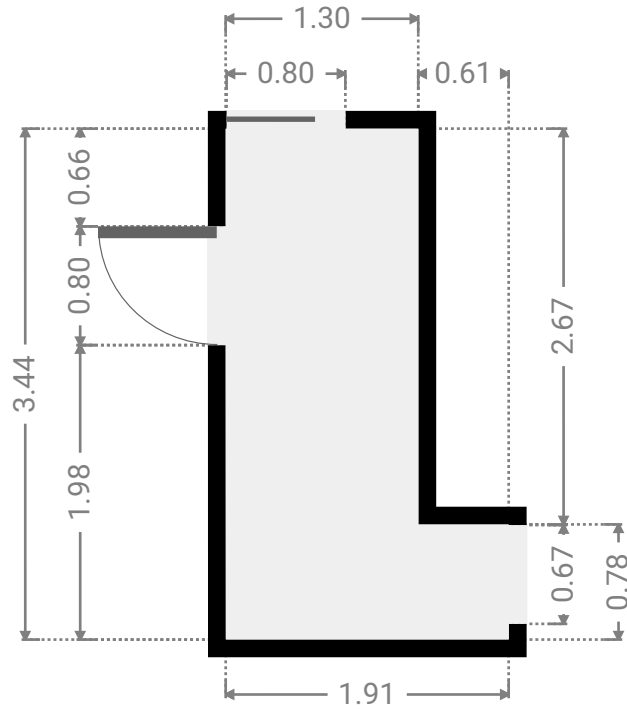
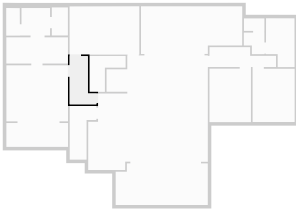

▼ **Hall**
1st Floor

WIDTH: 4.75 m • LENGTH: 1.42 m
AREA: 5.60 m² • PERIMETER: 12.34 m

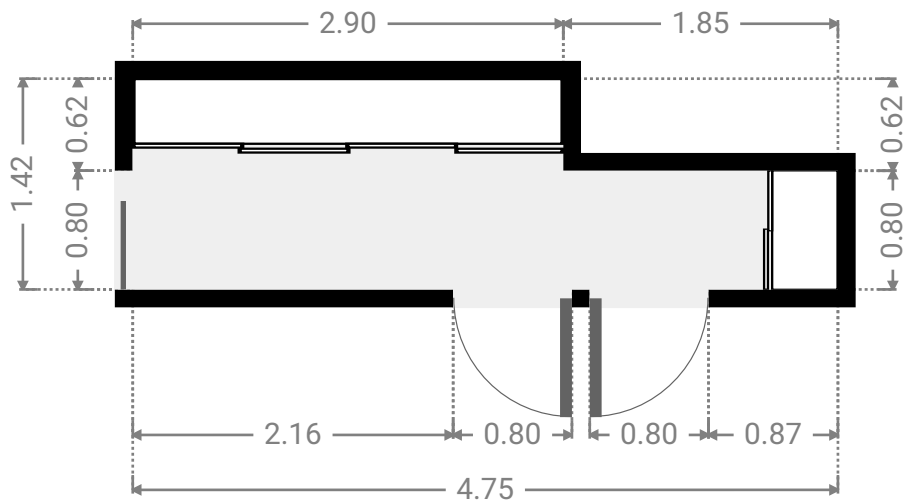
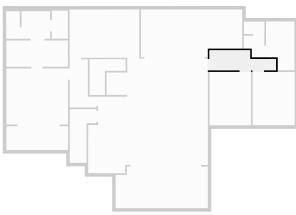

▼ Hall 1st Floor

WIDTH: 1.47 m • LENGTH: 1.54 m
AREA: 1.91 m² • PERIMETER: 6.02 m

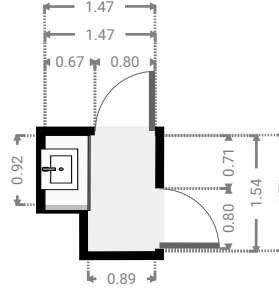
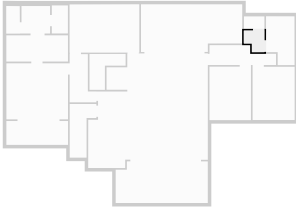

▼ Kitchen 1st Floor

WIDTH: 8.54 m • LENGTH: 8.20 m
AREA: 57.40 m² • PERIMETER: 33.46 m

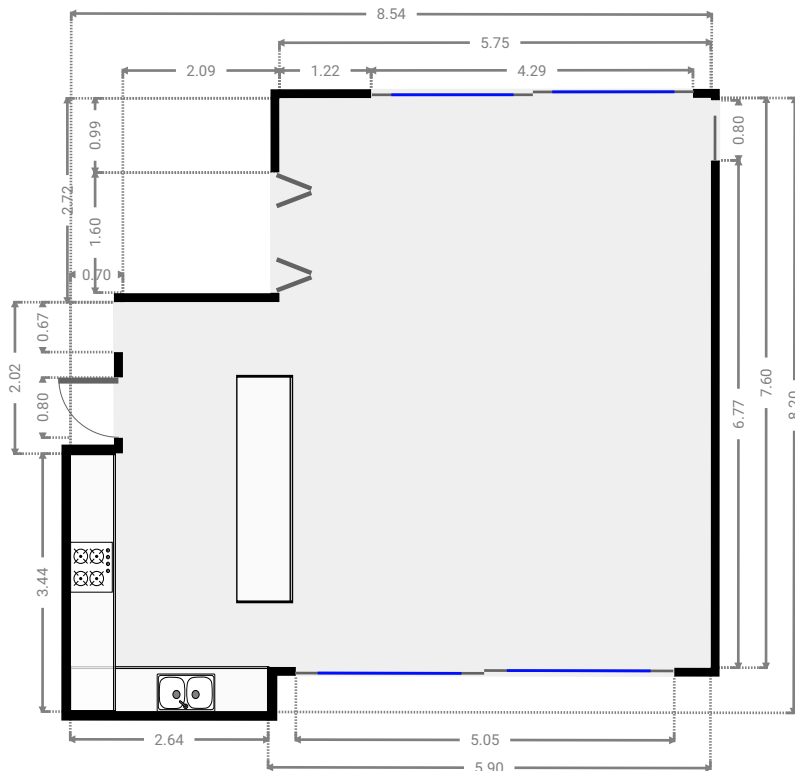
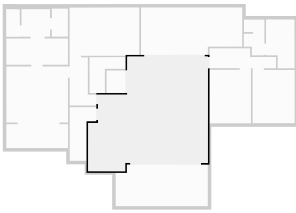

▼ **Closet**
1st Floor

WIDTH: 1.90 m • LENGTH: 3.83 m
AREA: 5.30 m² • PERIMETER: 11.46 m

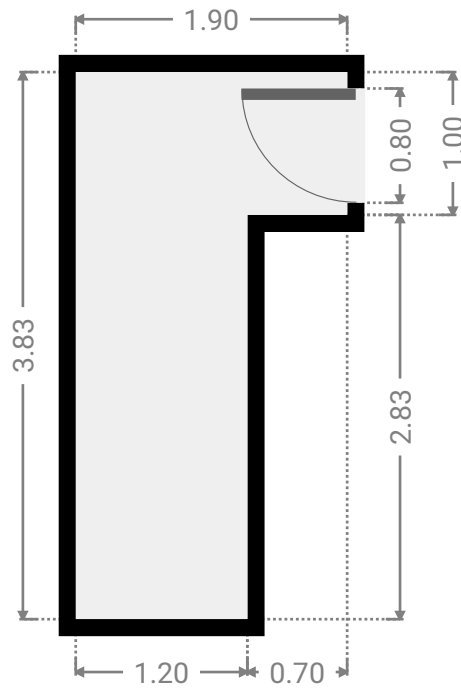
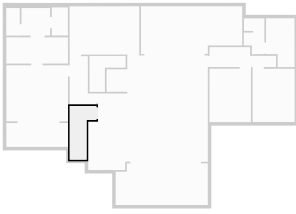

▼ **Living Room**
1st Floor

WIDTH: 4.98 m • LENGTH: 3.45 m
AREA: 17.15 m² • PERIMETER: 16.85 m

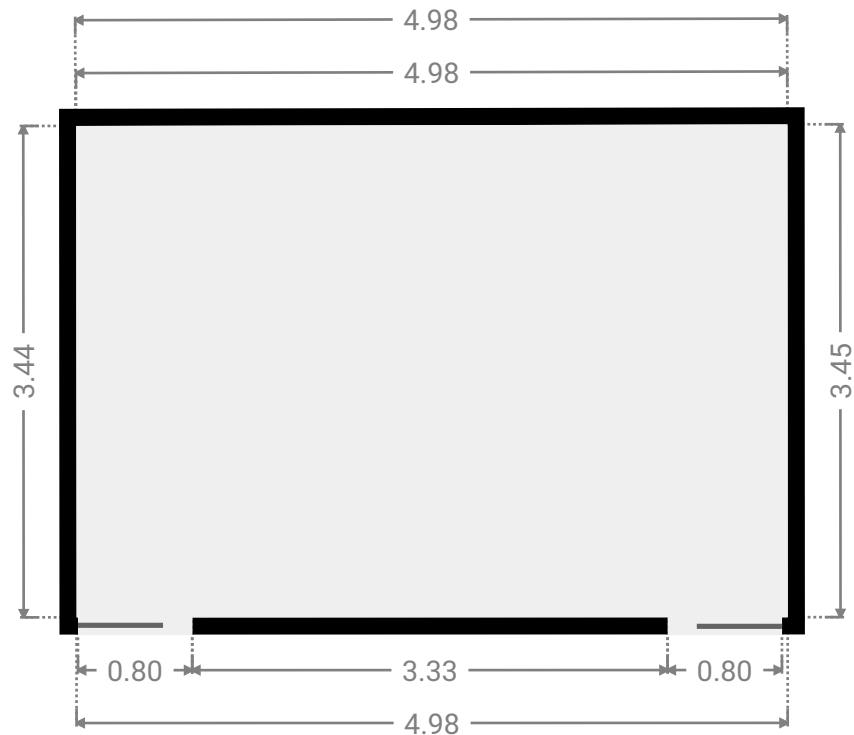
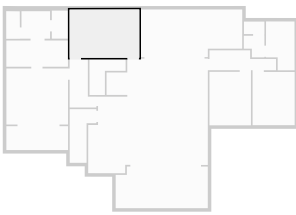

▼ Other
1st Floor

WIDTH: 7.24 m • LENGTH: 3.41 m
AREA: 23.12 m² • PERIMETER: 21.27 m

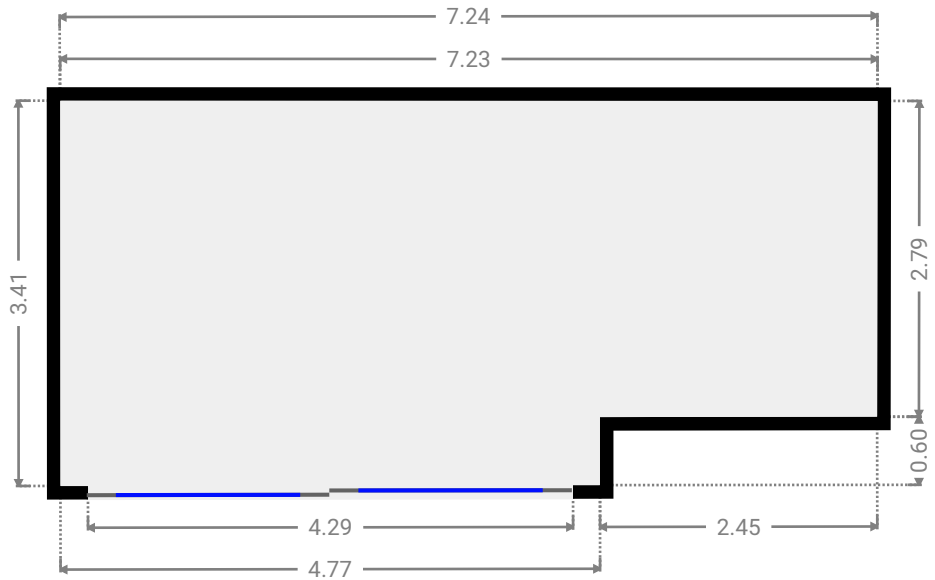
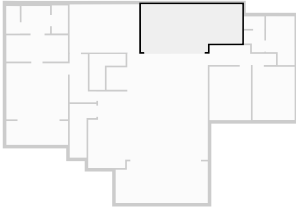

▼ Other
1st Floor

WIDTH: 6.58 m • LENGTH: 2.97 m
AREA: 19.07 m² • PERIMETER: 19.10 m

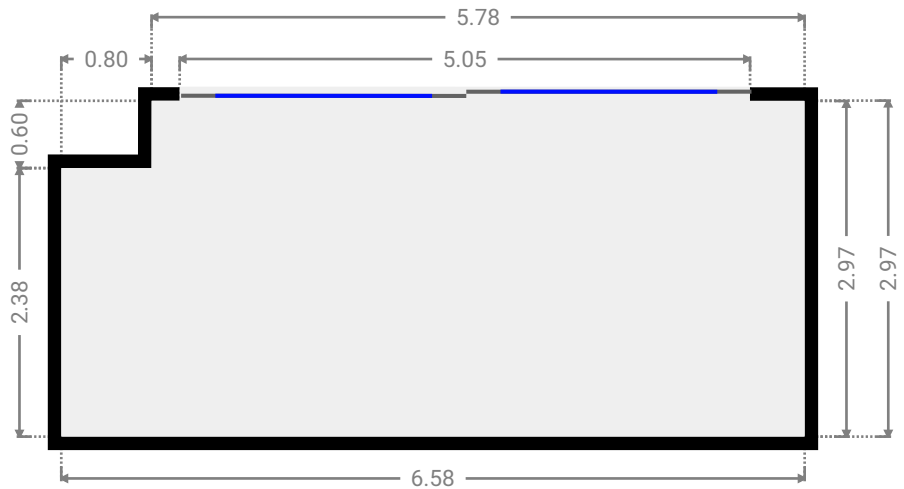
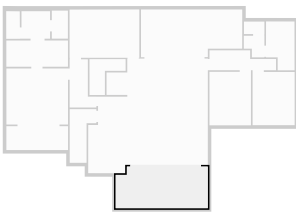

▼ Other
1st Floor

WIDTH: 4.40 m • LENGTH: 1.70 m
AREA: 7.50 m² • PERIMETER: 12.22 m

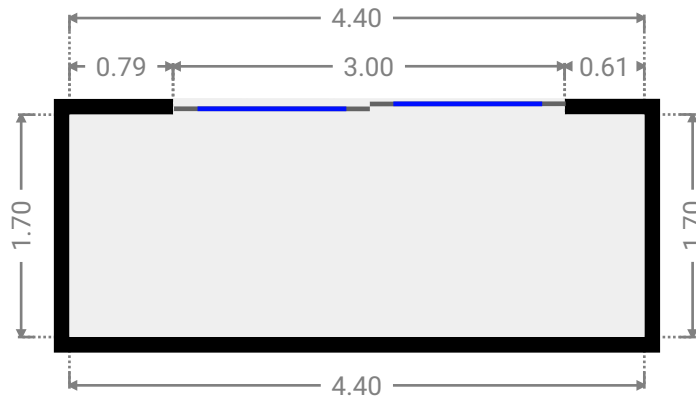
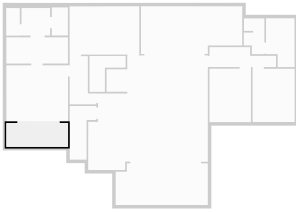

▼ Primary Bedroom
1st Floor

WIDTH: 4.40 m • LENGTH: 4.00 m
AREA: 17.60 m² • PERIMETER: 16.80 m

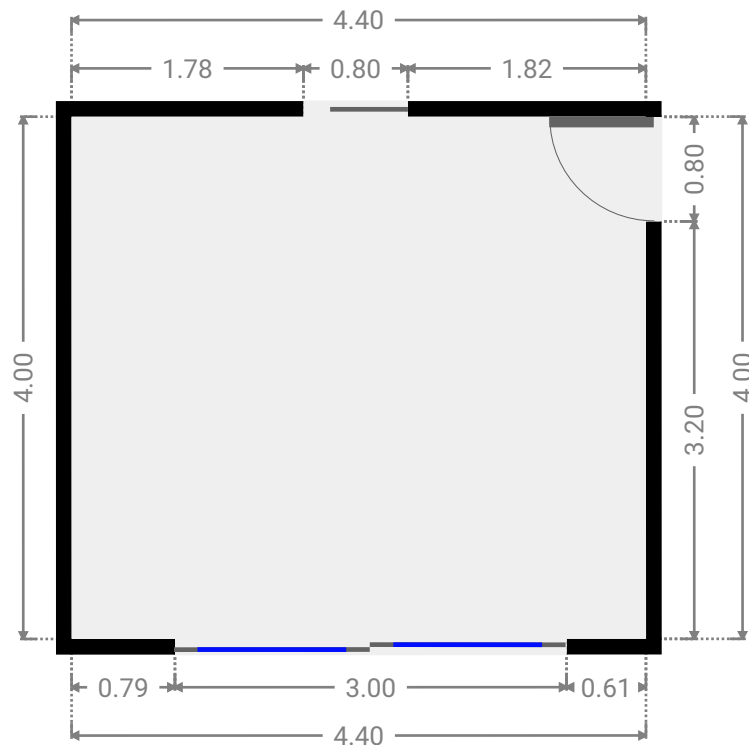
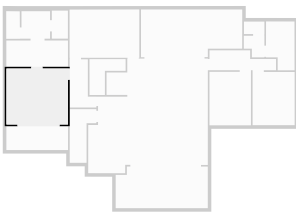

▼ **Stairway**
1st Floor

WIDTH: 2.58 m • LENGTH: 2.56 m
AREA: 4.05 m² • PERIMETER: 10.28 m

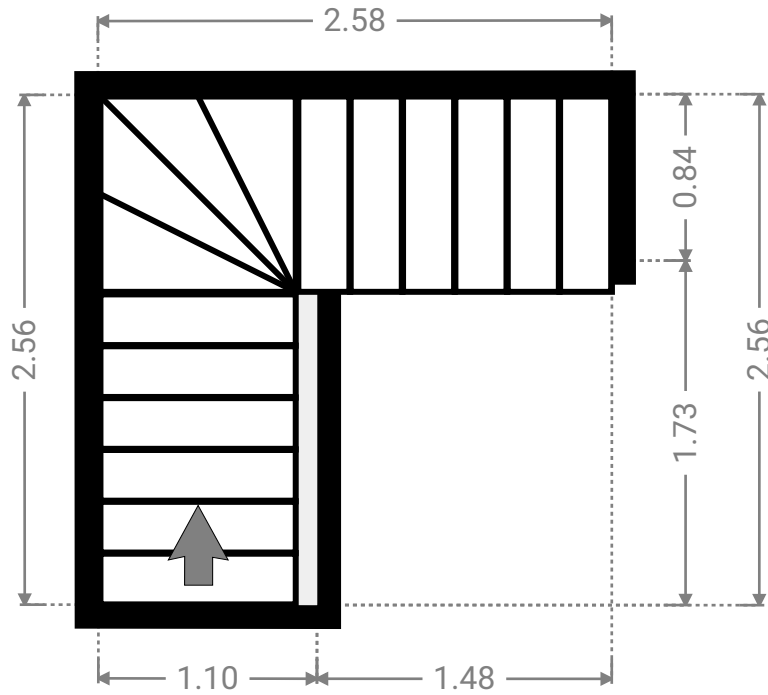
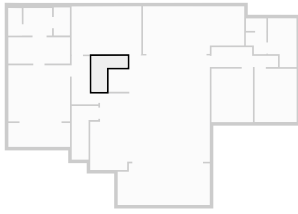

▼ **Study**
1st Floor

WIDTH: 1.36 m • LENGTH: 1.60 m
AREA: 2.18 m² • PERIMETER: 5.92 m

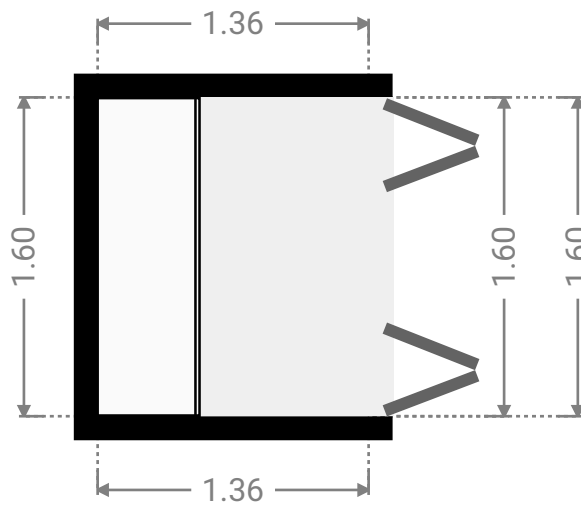
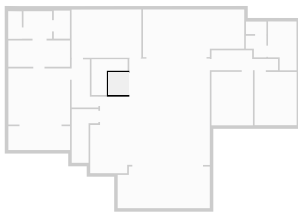

▼ Toilet
1st Floor

WIDTH: 0.98 m • LENGTH: 1.98 m
AREA: 1.91 m² • PERIMETER: 5.88 m

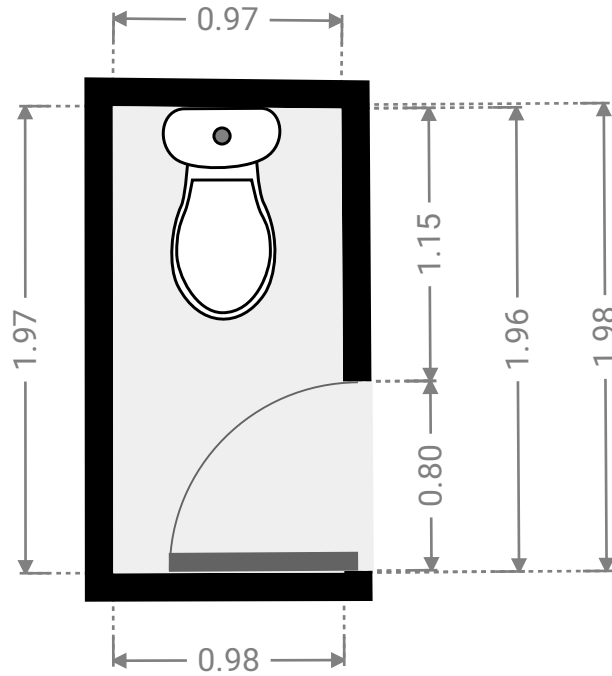
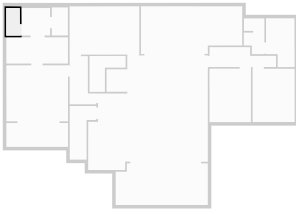

▼ Toilet
1st Floor

WIDTH: 1.46 m • LENGTH: 0.89 m
AREA: 1.30 m² • PERIMETER: 4.70 m

