

Ground Floor

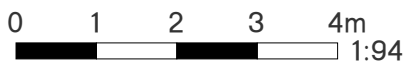

THIS FLOORPLAN IS PROVIDED WITHOUT WARRANTY OF ANY KIND. SENSOPIA DISCLAIMS ANY WARRANTY INCLUDING, WITHOUT LIMITATION, SATISFACTORY QUALITY OR ACCURACY OF DIMENSIONS.



14 Stan Jones Street

Entry

Width: 1.48 m
 Length: 4.73 m
 Area: 5.48 m²
 Perimeter: 12.41 m
 Ceiling Height: 2.17 m

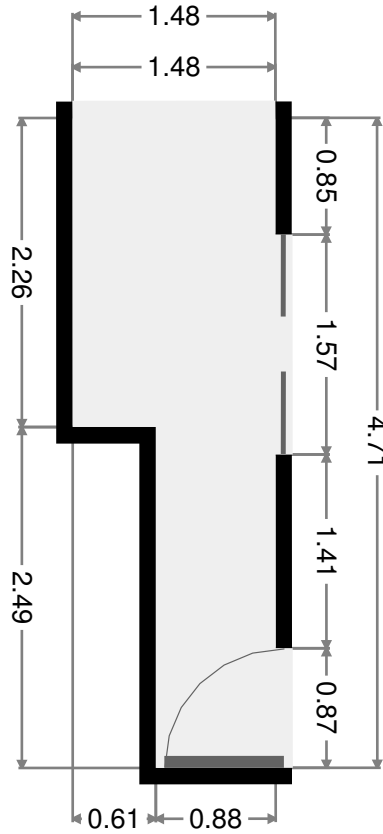
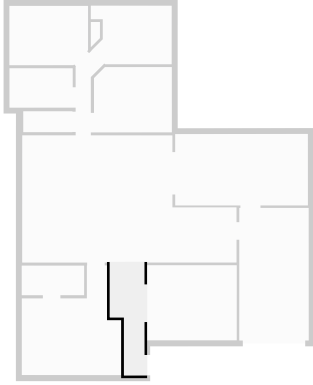

Living Room

Width: 3.21 m
 Length: 3.86 m
 Area: 12.37 m²
 Perimeter: 14.13 m

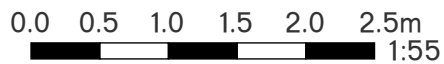
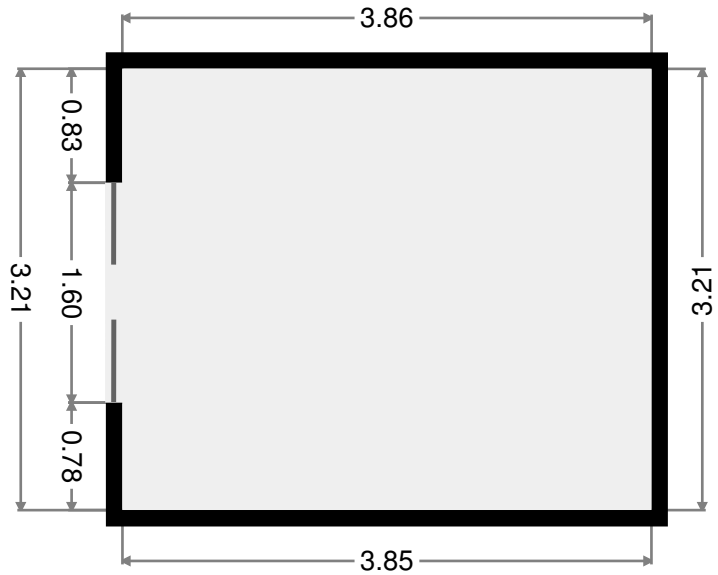
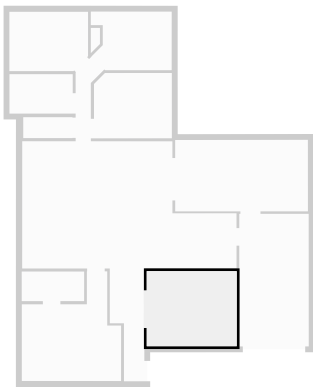

THIS FLOORPLAN IS PROVIDED WITHOUT WARRANTY OF ANY KIND. SENSOPIA DISCLAIMS ANY WARRANTY INCLUDING, WITHOUT LIMITATION, SATISFACTORY QUALITY OR ACCURACY OF DIMENSIONS.

Dining Room

Width: 5.44 m
 Length: 9.17 m
 Area: 41.42 m²
 Perimeter: 29.21 m
 Ceiling Height: 2.17 m

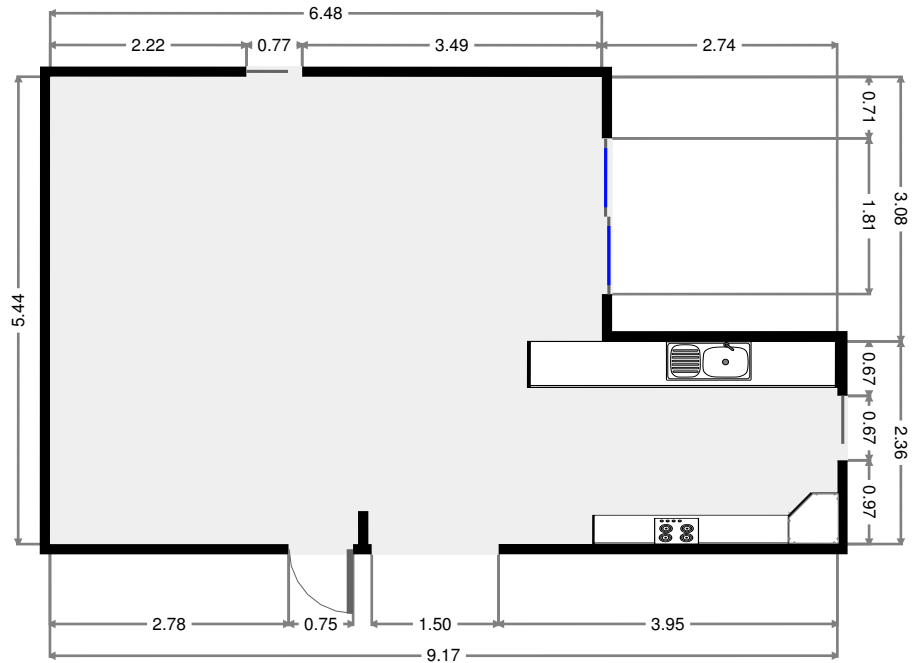
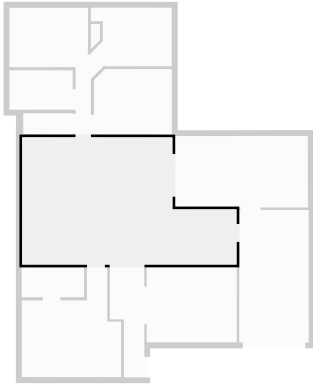

Master Bedroom

Width: 4.25 m
 Length: 4.69 m
 Area: 14.62 m²
 Perimeter: 17.87 m
 Ceiling Height: 2.17 m

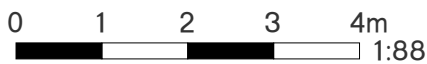
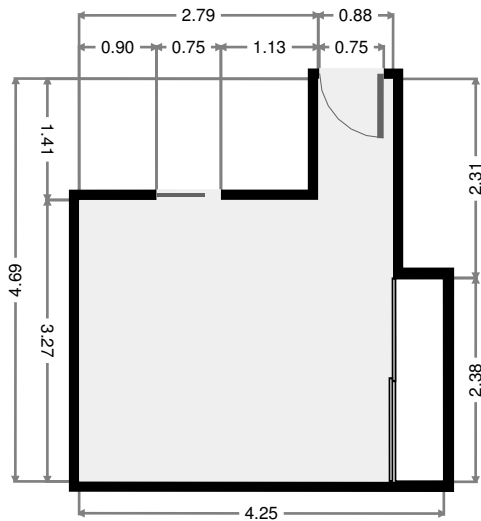
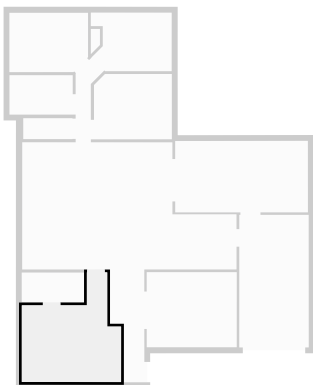

THIS FLOORPLAN IS PROVIDED WITHOUT WARRANTY OF ANY KIND. SENSOPIA DISCLAIMS ANY WARRANTY INCLUDING, WITHOUT LIMITATION, SATISFACTORY QUALITY OR ACCURACY OF DIMENSIONS.

Ensuite

Width: 1.27 m
 Length: 2.67 m
 Area: 3.38 m²
 Perimeter: 7.87 m

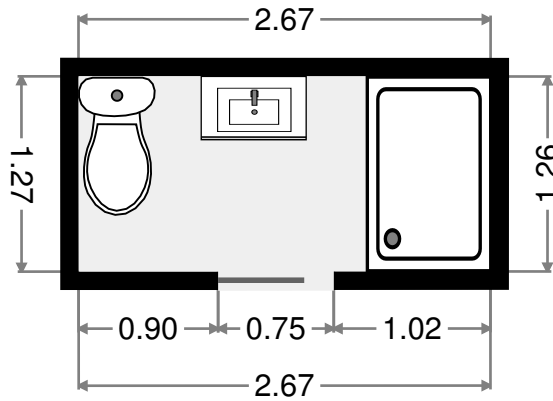
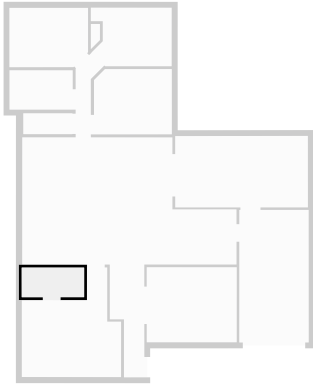

Hall

Width: 0.65 m
 Length: 2.84 m
 Area: 2.30 m²
 Perimeter: 8.21 m
 Ceiling Height: 2.17 m

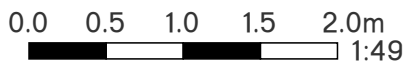
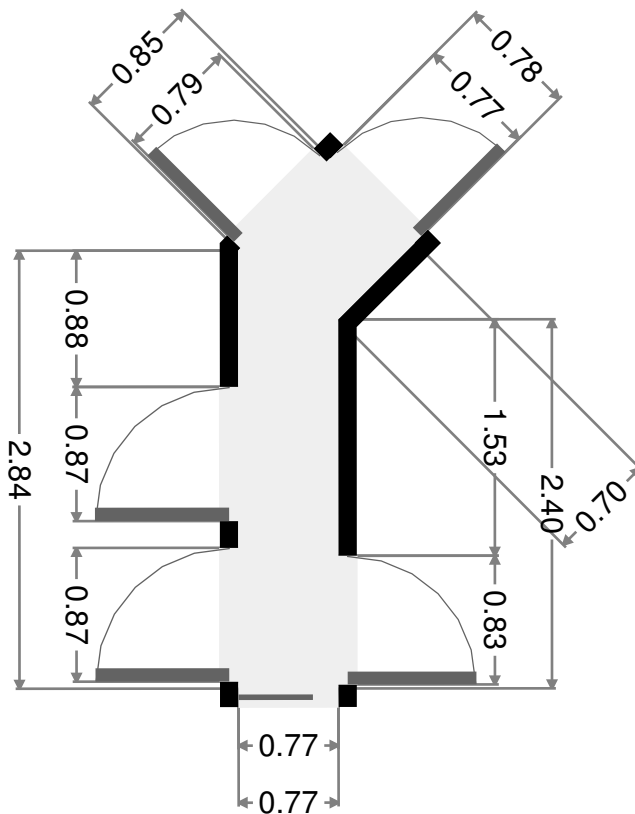
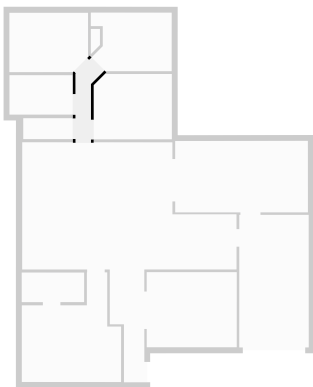

THIS FLOORPLAN IS PROVIDED WITHOUT WARRANTY OF ANY KIND. SENSOPIA DISCLAIMS ANY WARRANTY INCLUDING, WITHOUT LIMITATION, SATISFACTORY QUALITY OR ACCURACY OF DIMENSIONS.

Toilet

Width: 0.89 m
Length: 2.10 m
Area: 1.88 m²
Perimeter: 6.00 m

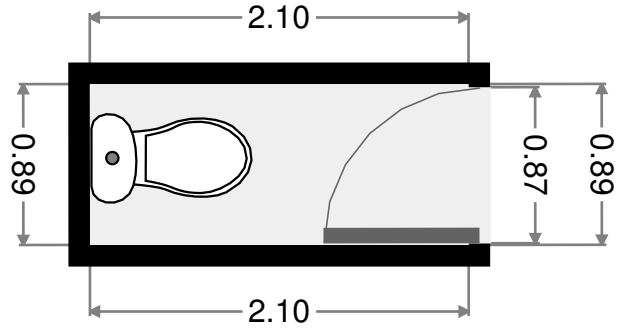
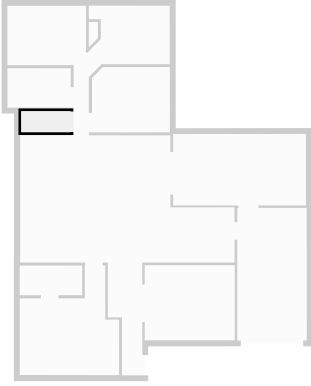

Bedroom

Width: 2.79 m
Length: 3.32 m
Area: 9.19 m²
Perimeter: 11.97 m

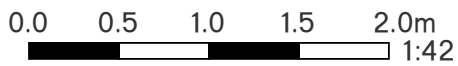
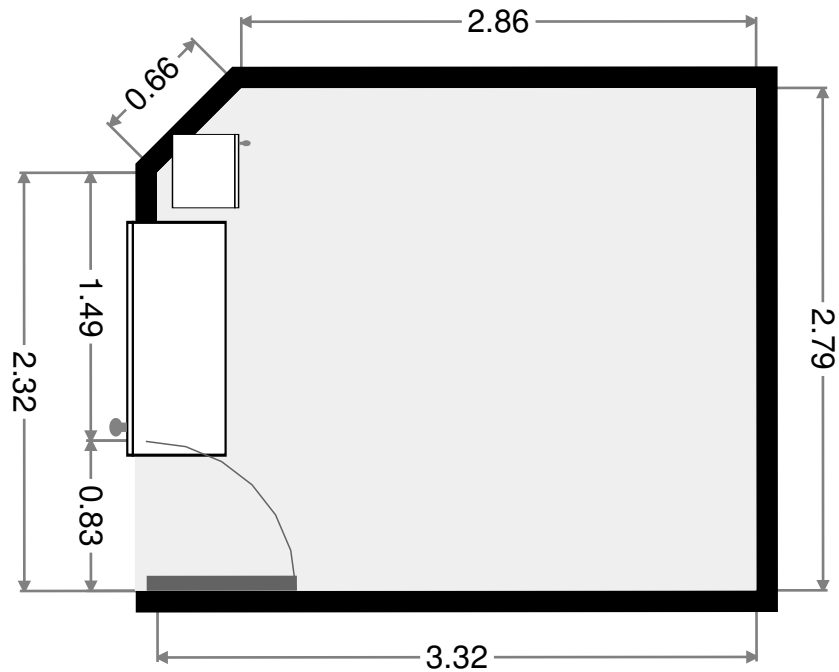
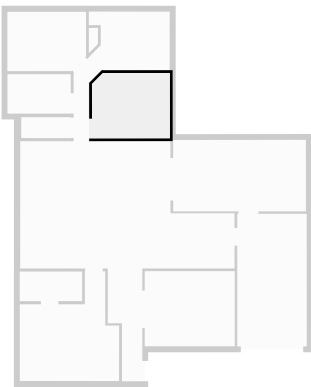

THIS FLOORPLAN IS PROVIDED WITHOUT WARRANTY OF ANY KIND. SENSOPIA DISCLAIMS ANY WARRANTY INCLUDING, WITHOUT LIMITATION, SATISFACTORY QUALITY OR ACCURACY OF DIMENSIONS.

Bathroom

Width: 1.68 m
Length: 2.71 m
Area: 4.56 m²
Perimeter: 8.78 m

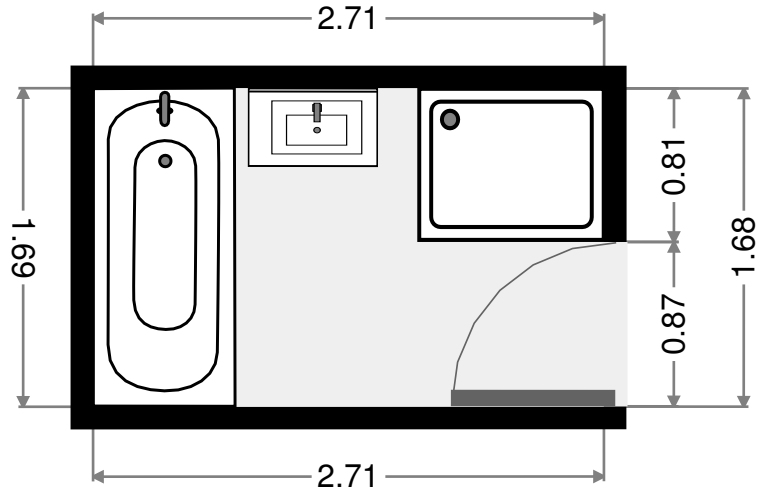
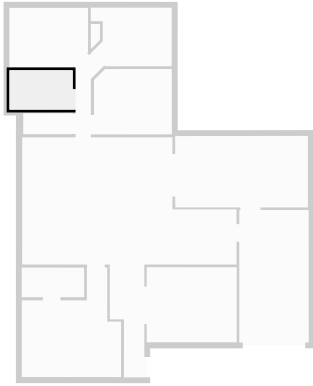

Bedroom

Width: 2.54 m
Length: 3.37 m
Area: 8.34 m²
Perimeter: 11.44 m
Ceiling Height: 2.17 m

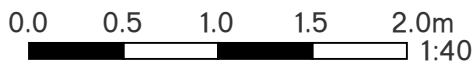
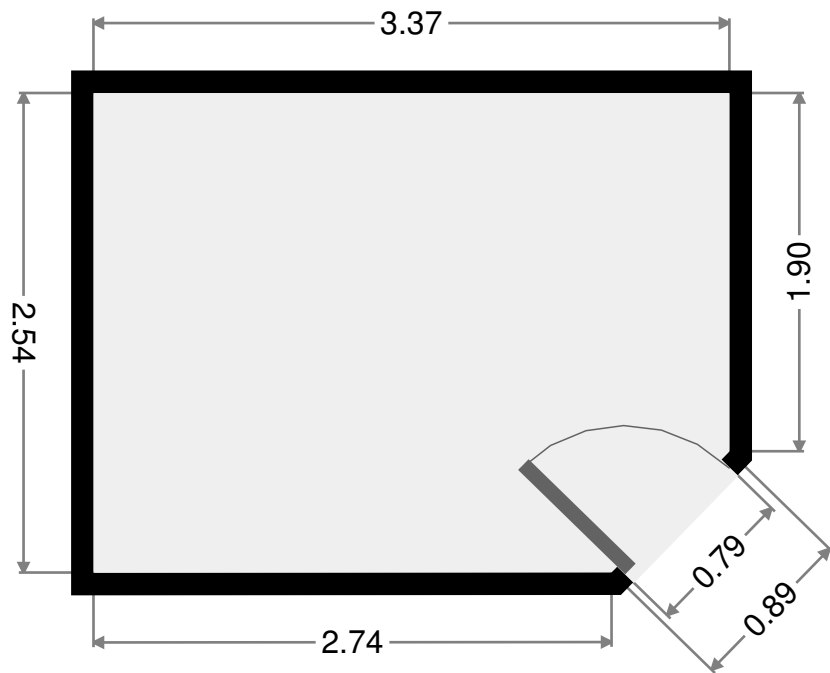
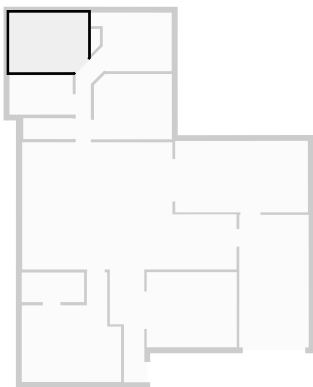

THIS FLOORPLAN IS PROVIDED WITHOUT WARRANTY OF ANY KIND. SENSOPIA DISCLAIMS ANY WARRANTY INCLUDING, WITHOUT LIMITATION, SATISFACTORY QUALITY OR ACCURACY OF DIMENSIONS.

Bedroom

Width: 2.50 m
 Length: 3.46 m
 Area: 7.91 m²
 Perimeter: 12.27 m
 Ceiling Height: 2.17 m

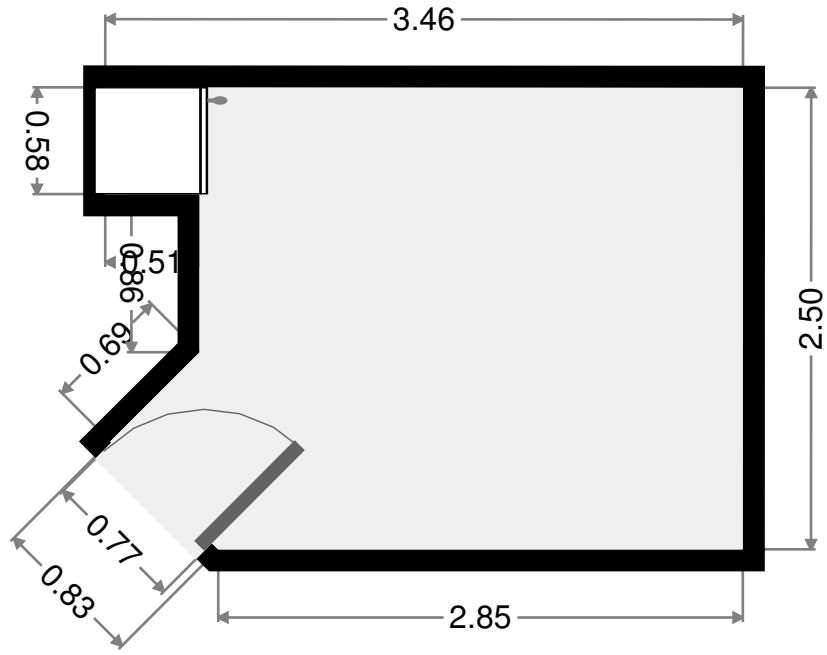
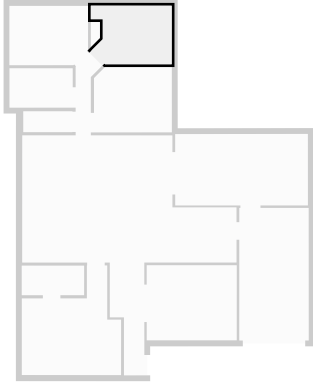

Closet

Width: 0.39 m
 Length: 1.08 m
 Area: 0.34 m²
 Perimeter: 2.71 m

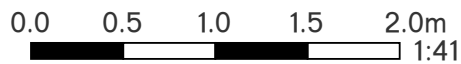
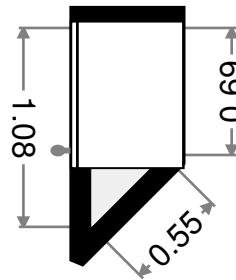
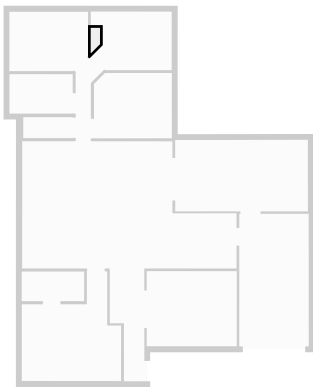

THIS FLOORPLAN IS PROVIDED WITHOUT WARRANTY OF ANY KIND. SENSOPIA DISCLAIMS ANY WARRANTY INCLUDING, WITHOUT LIMITATION, SATISFACTORY QUALITY OR ACCURACY OF DIMENSIONS.

Outdoor Area

Width: 3.07 m
 Length: 5.68 m
 Area: 17.35 m²
 Perimeter: 17.47 m

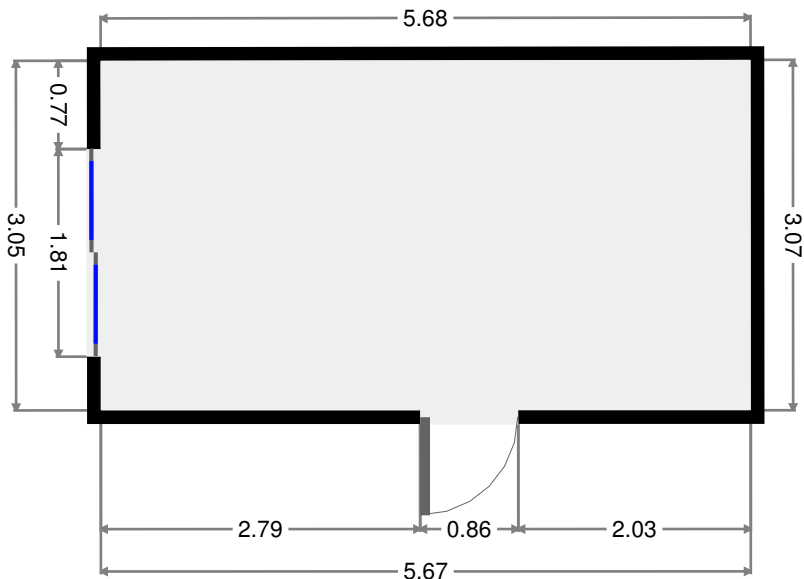
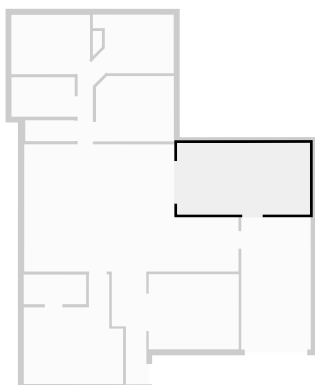

Garage

Width: 2.97 m
 Length: 5.67 m
 Area: 16.84 m²
 Perimeter: 17.28 m

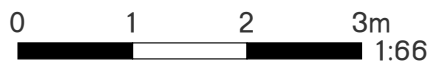
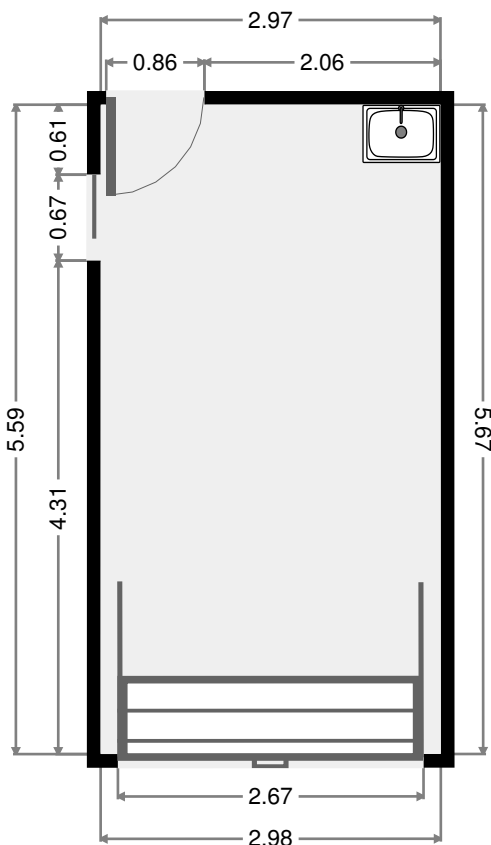
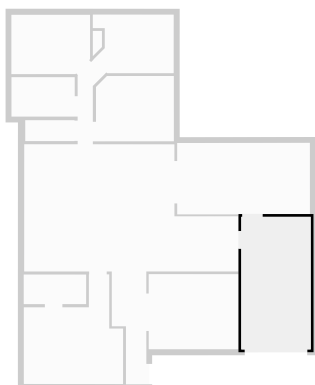

THIS FLOORPLAN IS PROVIDED WITHOUT WARRANTY OF ANY KIND. SENSOPIA DISCLAIMS ANY WARRANTY INCLUDING, WITHOUT LIMITATION, SATISFACTORY QUALITY OR ACCURACY OF DIMENSIONS.