

14 Luck Avenue

Created on
2021-07-29

Floors
2

▼ Ground Floor

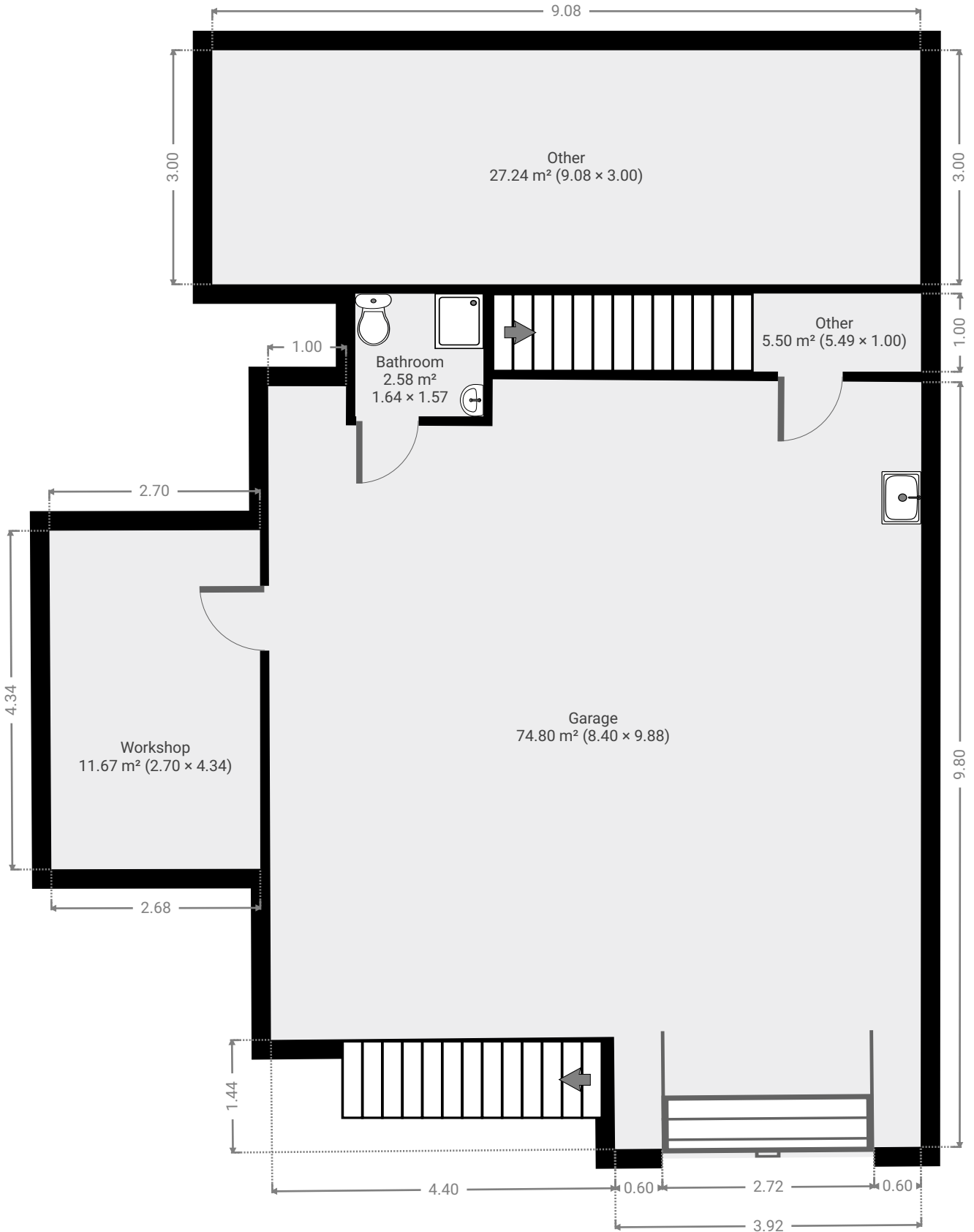

▼ **Garage**
Ground Floor

WIDTH: 8.39 m • LENGTH: 9.88 m
AREA: 74.80 m² • PERIMETER: 37.42 m

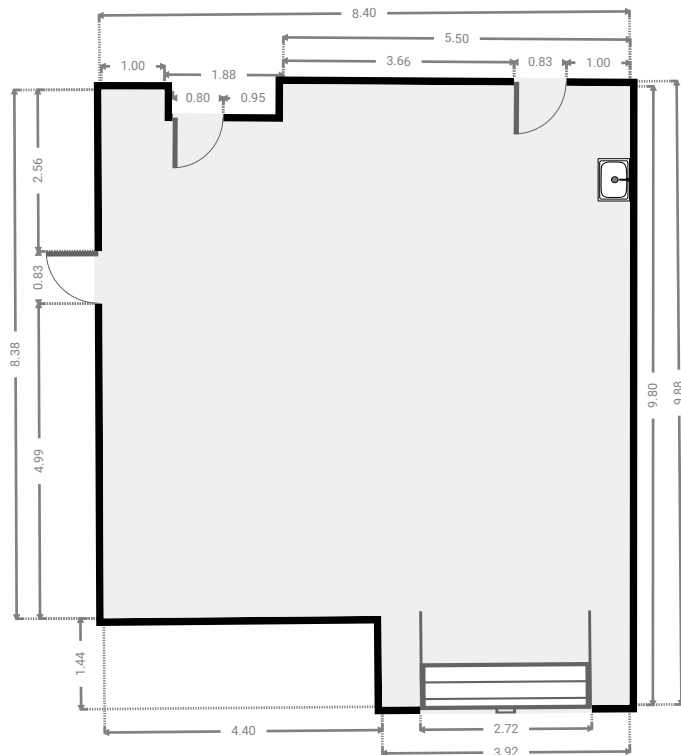
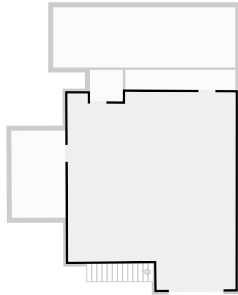

▼ **Bathroom**
Ground Floor

WIDTH: 1.64 m • LENGTH: 1.57 m
AREA: 2.58 m² • PERIMETER: 6.43 m

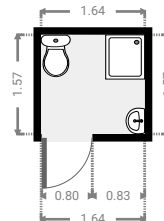
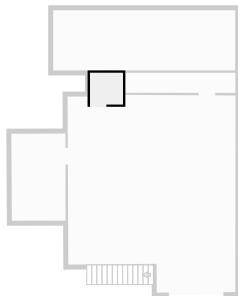

▼ Other
Ground Floor

WIDTH: 5.37 m • LENGTH: 1.00 m
AREA: 5.50 m² • PERIMETER: 12.98 m

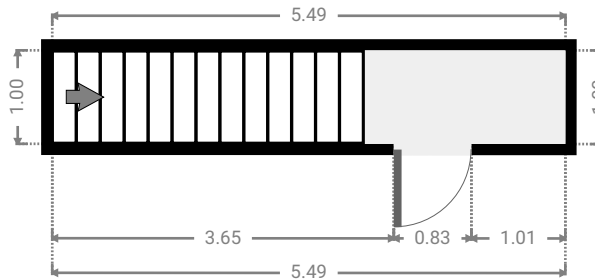
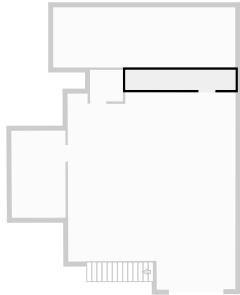

▼ Other
Ground Floor

WIDTH: 9.08 m • LENGTH: 3.00 m
AREA: 27.24 m² • PERIMETER: 24.16 m

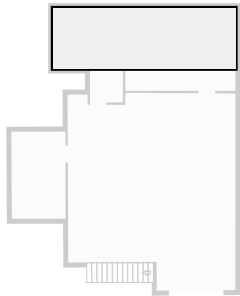

▼ Workshop
Ground Floor

WIDTH: 2.70 m • LENGTH: 4.34 m
AREA: 11.67 m² • PERIMETER: 14.06 m

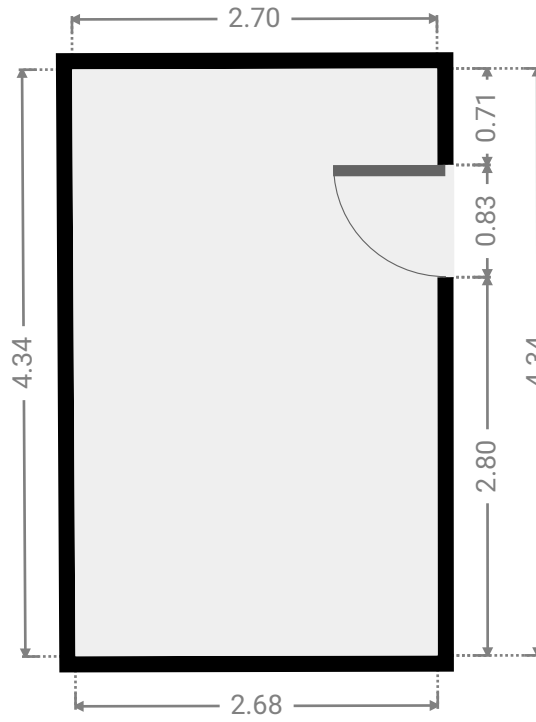
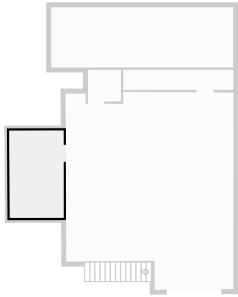

▼ 1st Floor



▼ Living Room
1st Floor

WIDTH: 4.19 m • LENGTH: 6.06 m
AREA: 25.38 m² • PERIMETER: 20.50 m

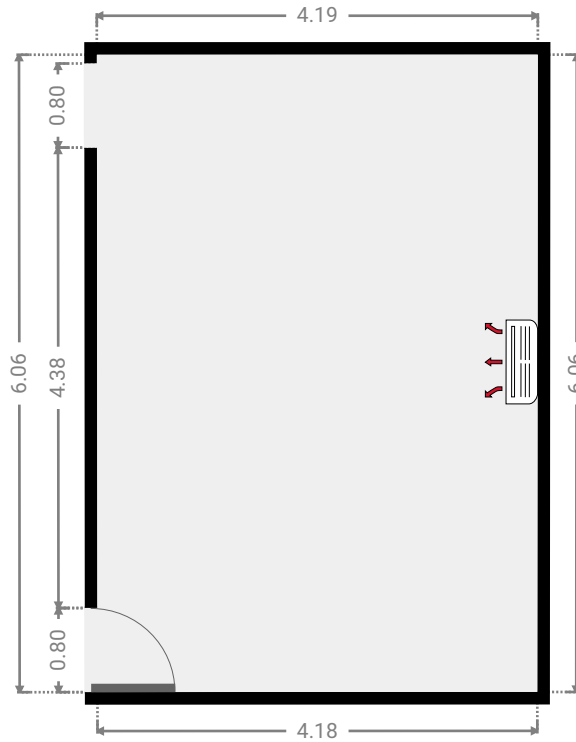
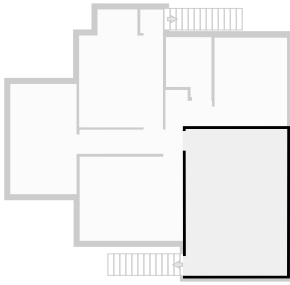

▼ Hall
1st Floor

WIDTH: 4.27 m • LENGTH: 1.00 m
AREA: 4.27 m² • PERIMETER: 10.54 m

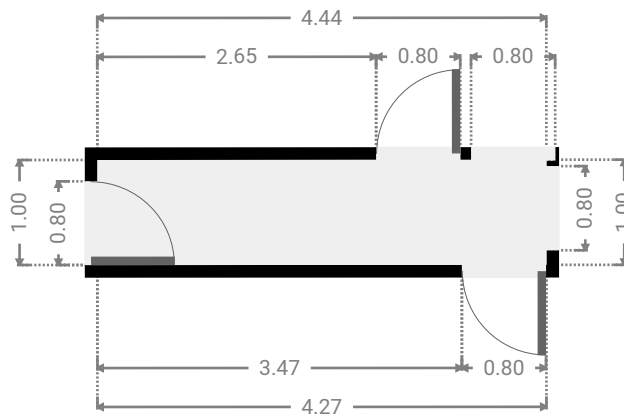
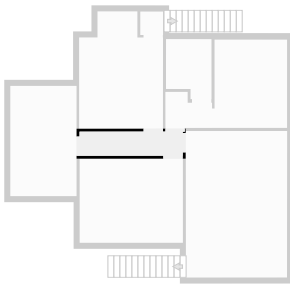

▼ **Master Bedroom**
1st Floor

WIDTH: 4.27 m • LENGTH: 3.48 m
AREA: 14.86 m² • PERIMETER: 15.50 m

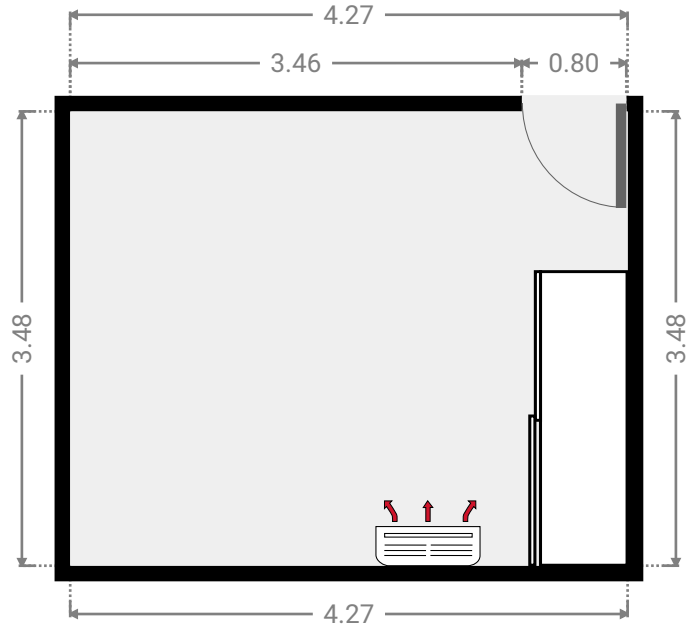
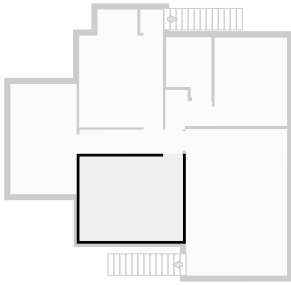

▼ **Bedroom**
1st Floor

WIDTH: 2.74 m • LENGTH: 4.56 m
AREA: 12.49 m² • PERIMETER: 14.60 m

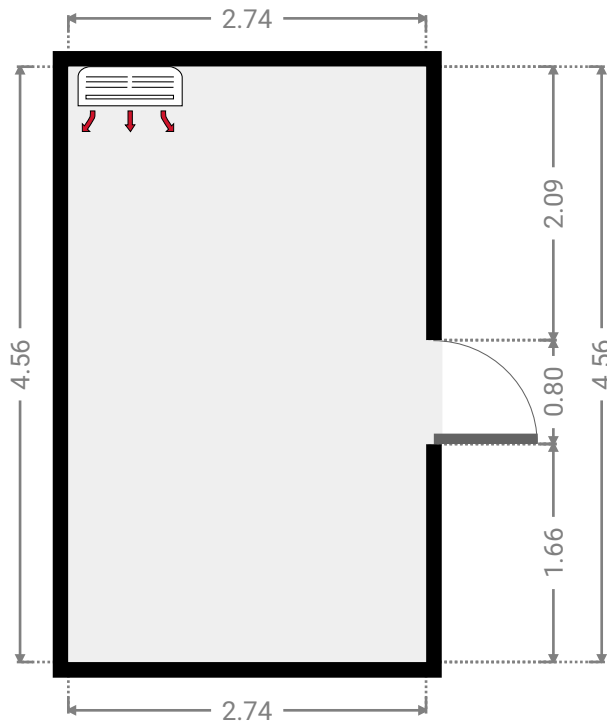
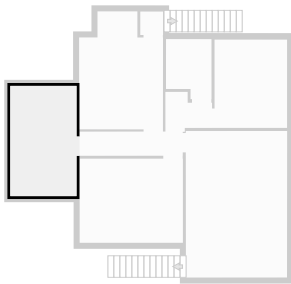

▼ Kitchen
1st Floor

WIDTH: 3.47 m • LENGTH: 4.88 m
AREA: 14.96 m² • PERIMETER: 16.69 m

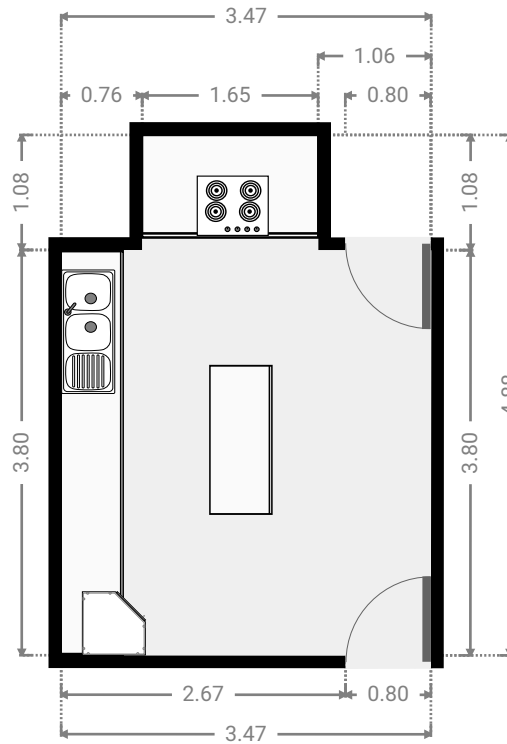
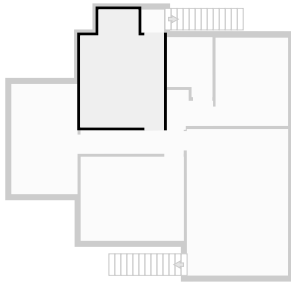

▼ Other
1st Floor

WIDTH: 0.94 m • LENGTH: 0.97 m
AREA: 0.91 m² • PERIMETER: 3.82 m

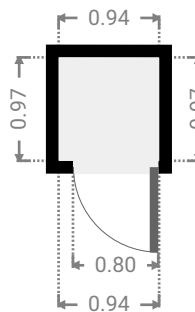
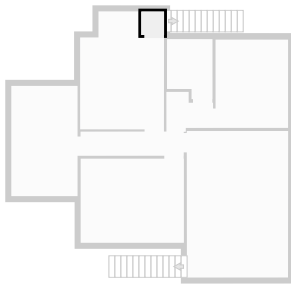

▼ **Hall**
1st Floor

WIDTH: 1.93 m • LENGTH: 1.49 m
AREA: 2.42 m² • PERIMETER: 6.84 m

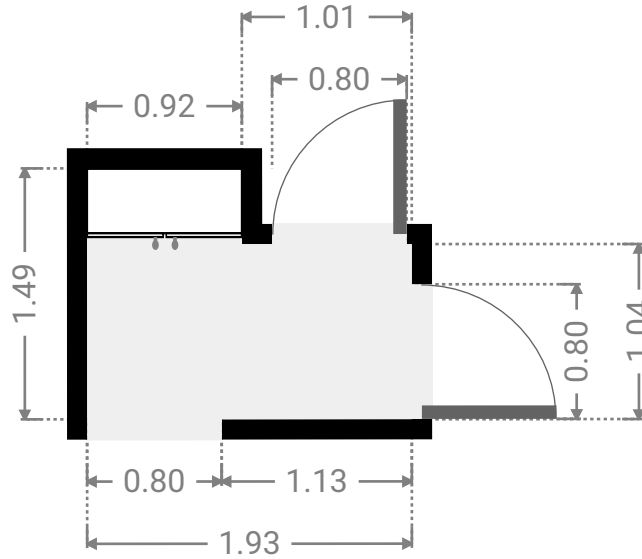
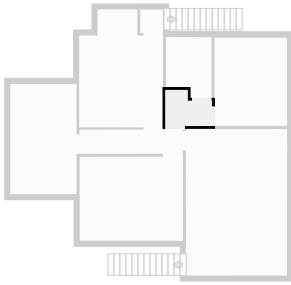

▼ **Bathroom**
1st Floor

WIDTH: 1.88 m • LENGTH: 2.48 m
AREA: 4.24 m² • PERIMETER: 8.73 m

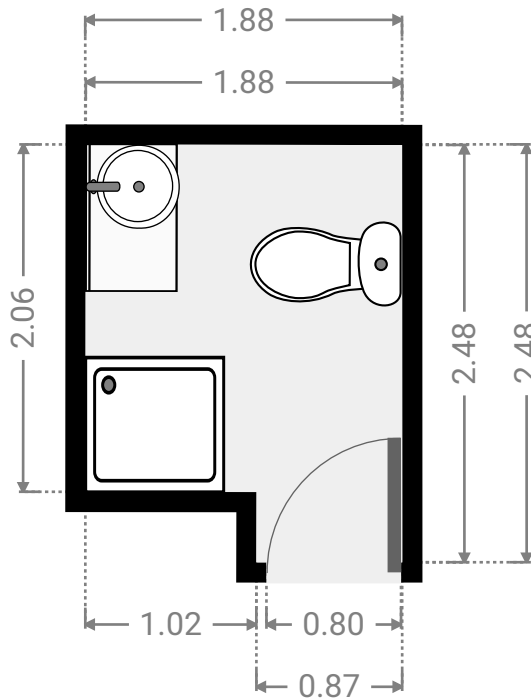
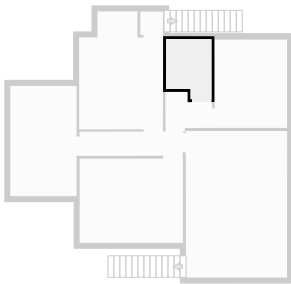

▼ **Bedroom**
1st Floor

WIDTH: 3.00 m • LENGTH: 3.65 m
AREA: 10.95 m² • PERIMETER: 13.30 m

