

14 Cycad Court

Ground Floor

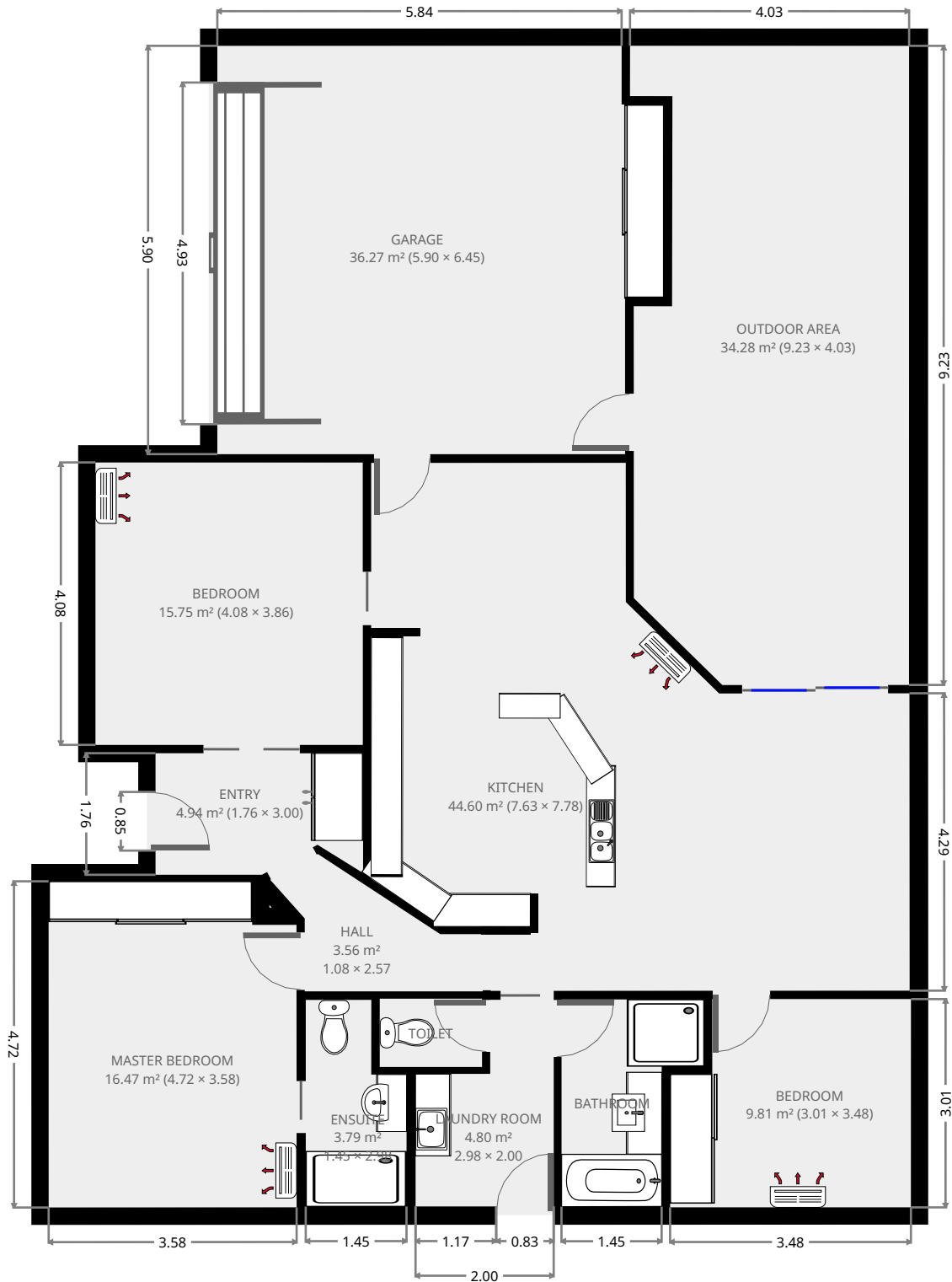

THIS FLOORPLAN IS PROVIDED WITHOUT WARRANTY OF ANY KIND. SENSOPIA DISCLAIMS ANY WARRANTY INCLUDING, WITHOUT LIMITATION, SATISFACTORY QUALITY OR ACCURACY OF DIMENSIONS.



14 Cycad Court

Entry

Width: 1.76 m
 Length: 3.00 m
 Area: 4.94 m²
 Perimeter: 9.71 m

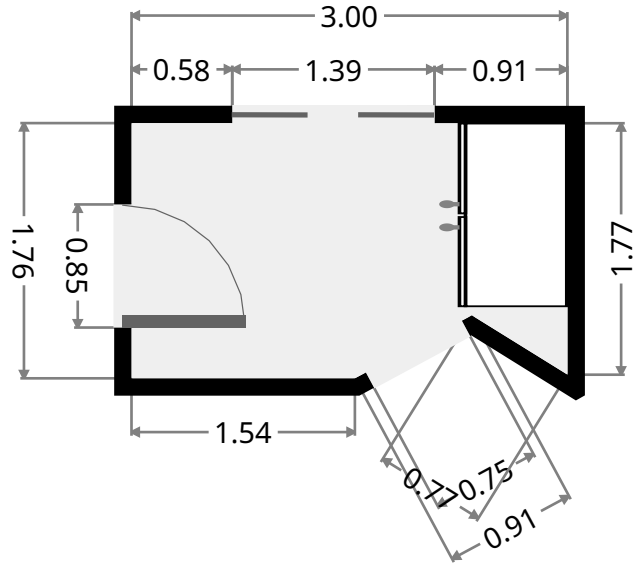
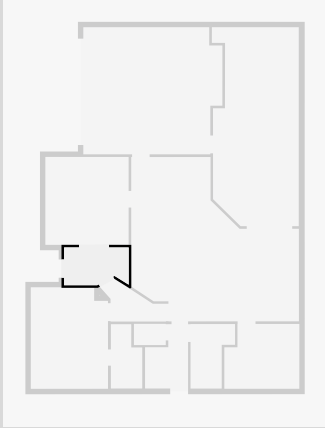

Bedroom

Width: 3.86 m
 Length: 4.08 m
 Area: 15.75 m²
 Perimeter: 15.88 m

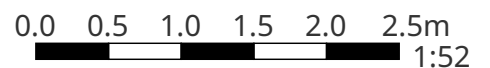
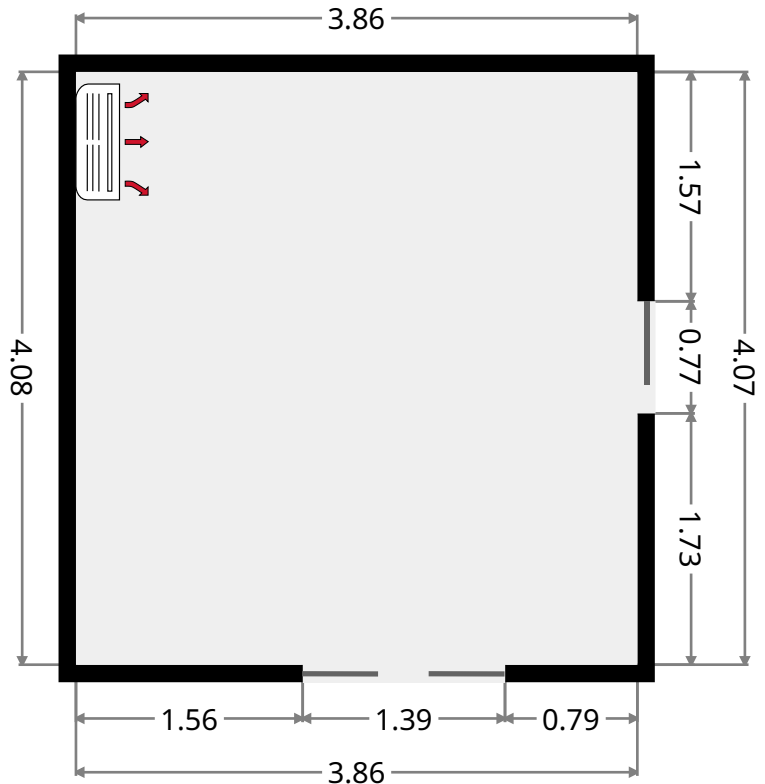
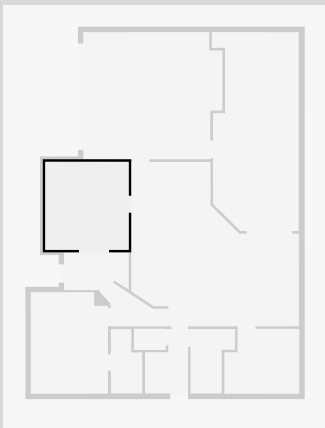

THIS FLOORPLAN IS PROVIDED WITHOUT WARRANTY OF ANY KIND. SENSOPIA DISCLAIMS ANY WARRANTY INCLUDING, WITHOUT LIMITATION, SATISFACTORY QUALITY OR ACCURACY OF DIMENSIONS.

14 Cycad Court

Hall

Width:	1.08 m
Length:	2.57 m
Area	3.56 m ²
Perimeter	8.71 m

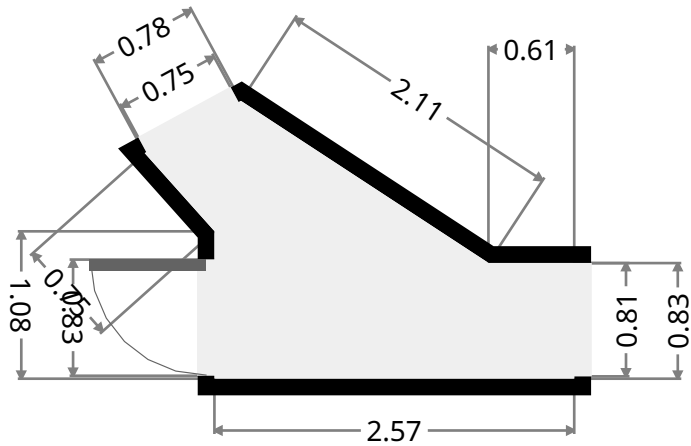
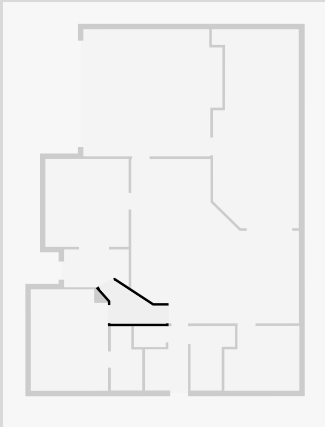

Master Bedroom

Width:	3.58 m
Length:	4.72 m
Area	16.47 m ²
Perimeter	16.59 m

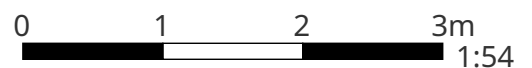
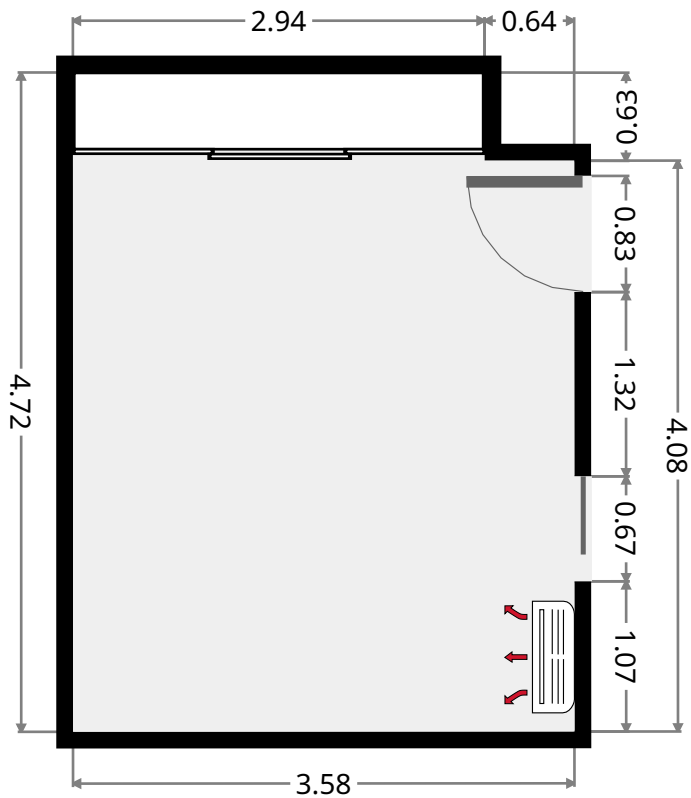

THIS FLOORPLAN IS PROVIDED WITHOUT WARRANTY OF ANY KIND. SENSOPIA DISCLAIMS ANY WARRANTY INCLUDING, WITHOUT LIMITATION, SATISFACTORY QUALITY OR ACCURACY OF DIMENSIONS.

14 Cycad Court

Ensuite

Width: 1.45 m
 Length: 2.98 m
 Area: 3.79 m²
 Perimeter: 8.88 m

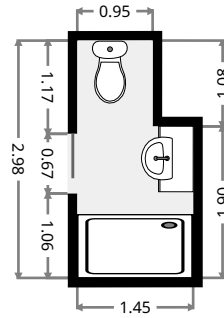
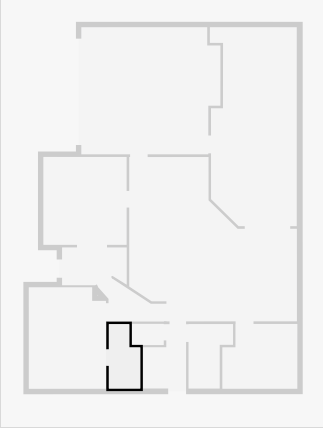

Kitchen

Width: 7.63 m
 Length: 7.78 m
 Area: 44.60 m²
 Perimeter: 29.55 m

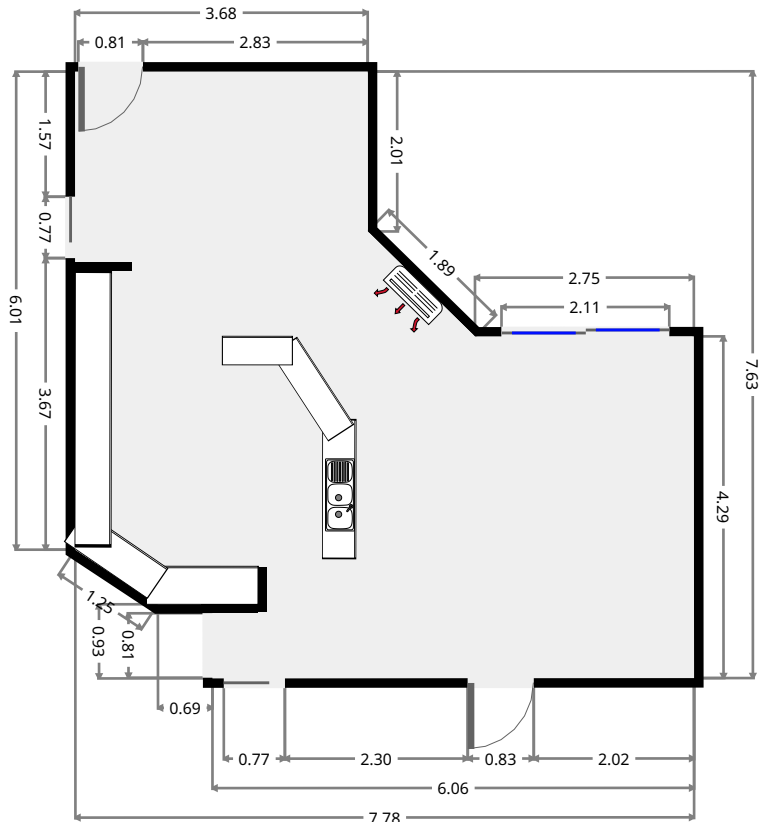
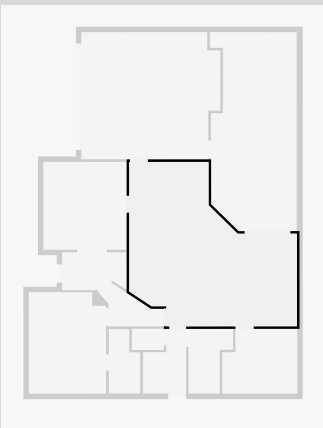

THIS FLOORPLAN IS PROVIDED WITHOUT WARRANTY OF ANY KIND. SENSOPIA DISCLAIMS ANY WARRANTY INCLUDING, WITHOUT LIMITATION, SATISFACTORY QUALITY OR ACCURACY OF DIMENSIONS.

14 Cycad Court

Laundry Room

Width: 2.00 m
 Length: 2.98 m
 Area: 4.80 m²
 Perimeter: 9.96 m

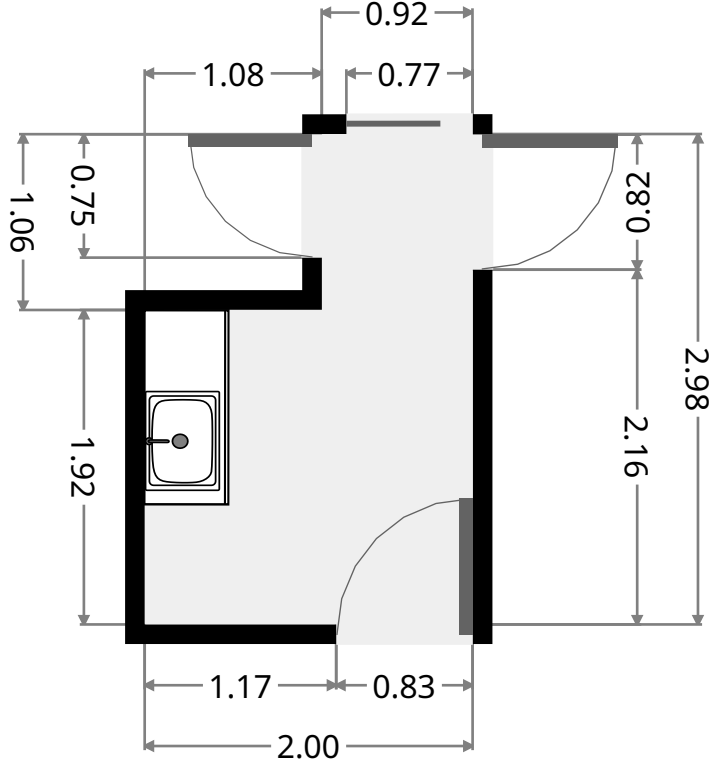
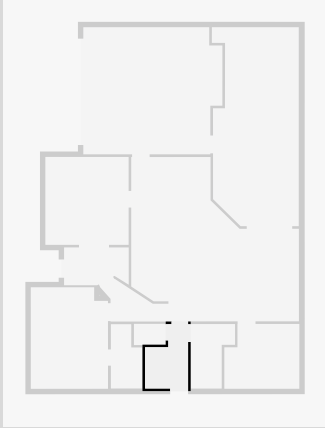

Toilet

Width: 0.99 m
 Length: 1.48 m
 Area: 1.46 m²
 Perimeter: 4.93 m

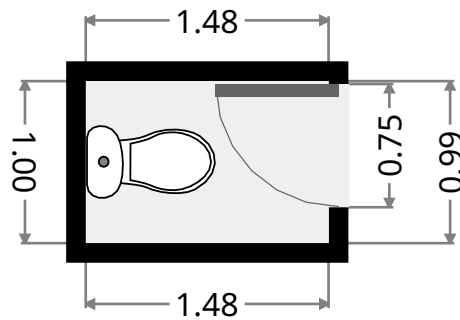
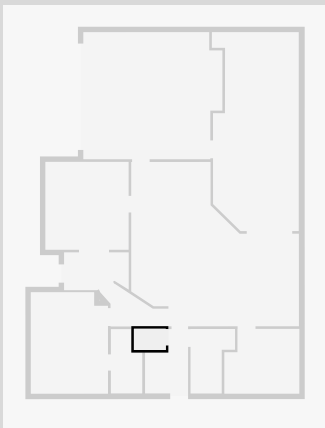

14 Cycad Court

Bathroom

Width: 2.07 m
 Length: 2.99 m
 Area: 4.93 m²
 Perimeter: 10.12 m

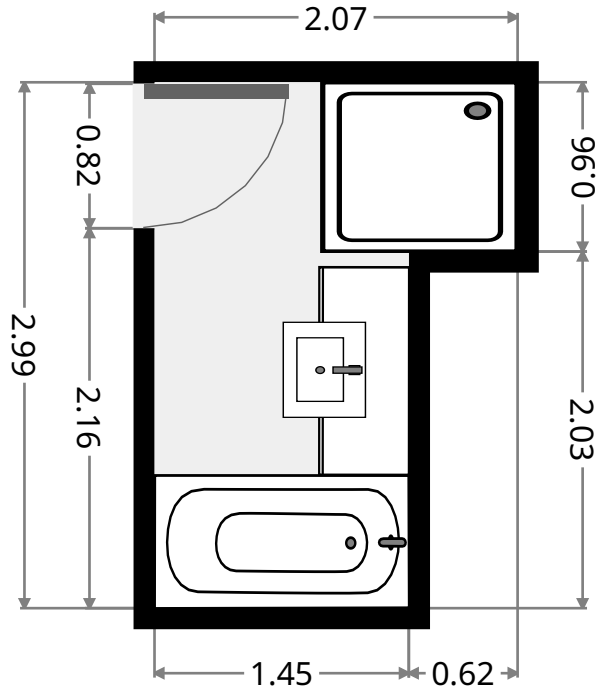
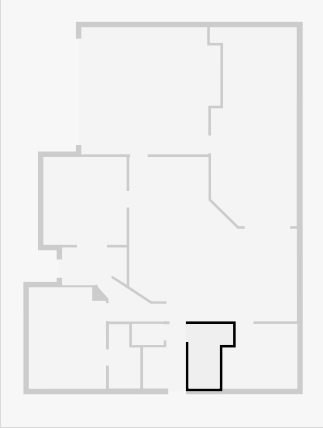

Bedroom

Width: 3.01 m
 Length: 3.48 m
 Area: 9.81 m²
 Perimeter: 12.98 m

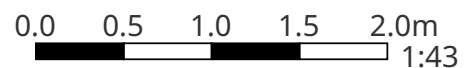
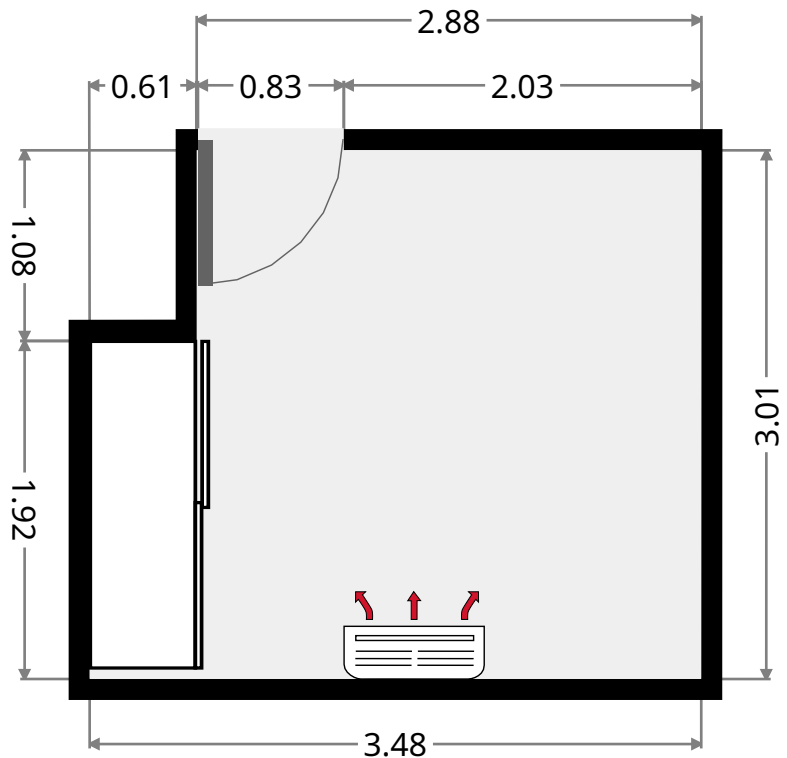

THIS FLOORPLAN IS PROVIDED WITHOUT WARRANTY OF ANY KIND. SENSOPIA DISCLAIMS ANY WARRANTY INCLUDING, WITHOUT LIMITATION, SATISFACTORY QUALITY OR ACCURACY OF DIMENSIONS.

14 Cycad Court

Garage

Width: 5.90 m
 Length: 6.45 m
 Area: 36.27 m²
 Perimeter: 24.70 m

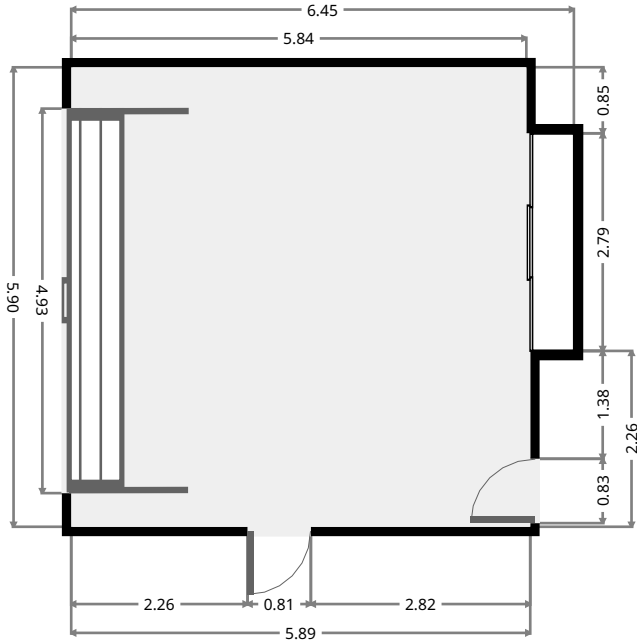
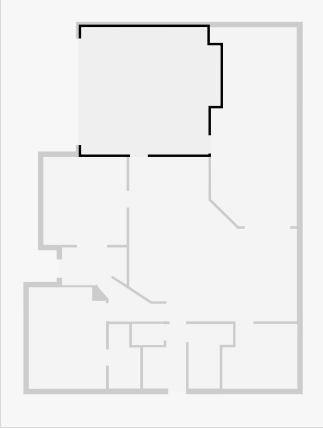

Outdoor Area

Width: 4.03 m
 Length: 9.23 m
 Area: 34.28 m²
 Perimeter: 26.90 m

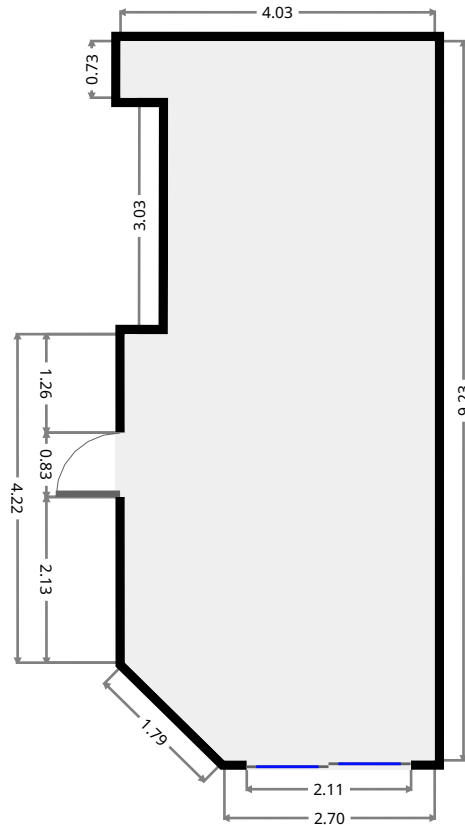
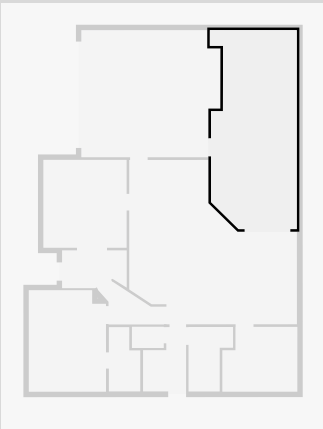

THIS FLOORPLAN IS PROVIDED WITHOUT WARRANTY OF ANY KIND. SENSOPIA DISCLAIMS ANY WARRANTY INCLUDING, WITHOUT LIMITATION, SATISFACTORY QUALITY OR ACCURACY OF DIMENSIONS.