

14 Belbowrie Avenue

Ground Floor

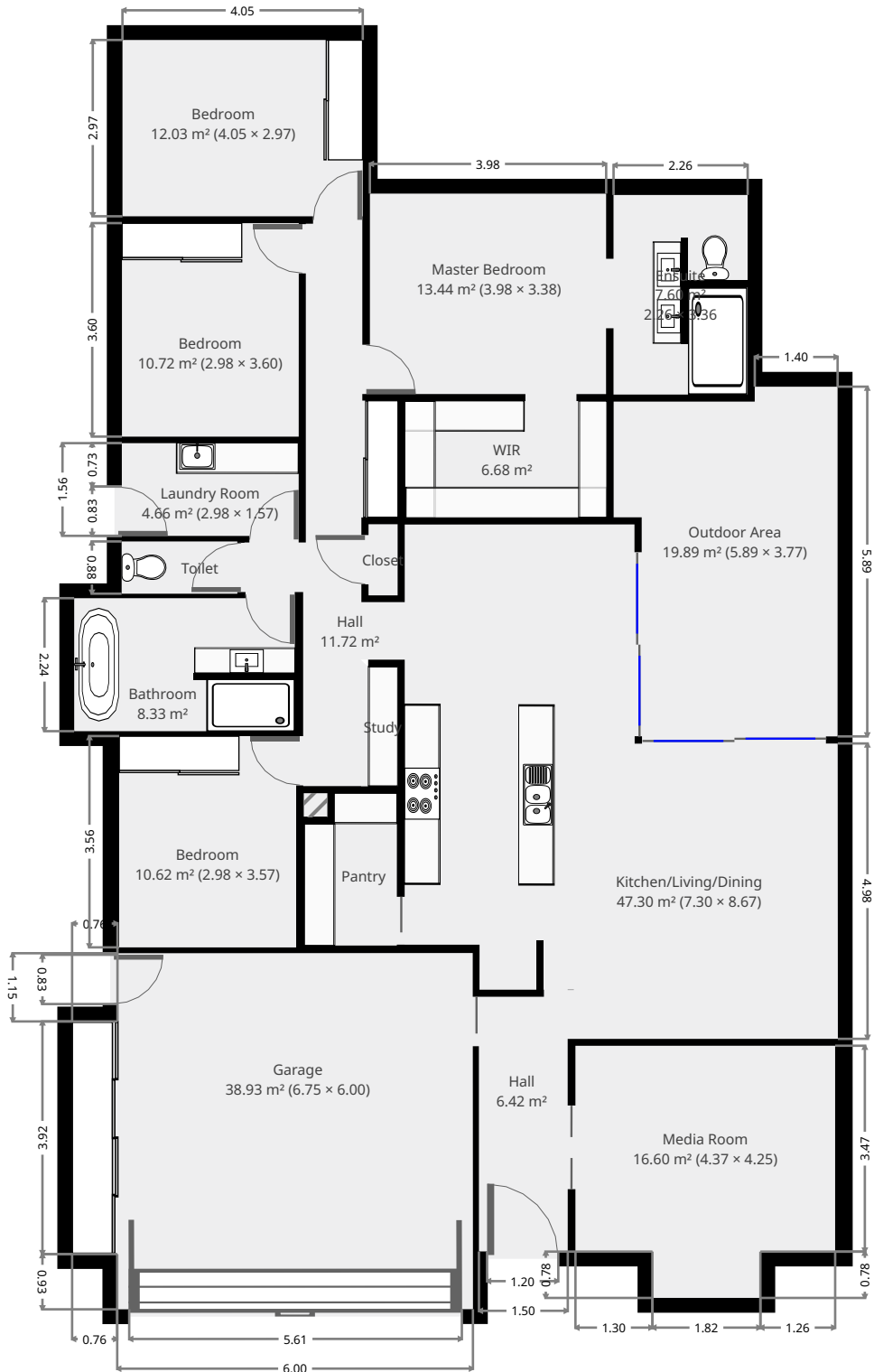

THIS FLOORPLAN IS PROVIDED WITHOUT WARRANTY OF ANY KIND. SENSOPIA DISCLAIMS ANY WARRANTY INCLUDING, WITHOUT LIMITATION, SATISFACTORY QUALITY OR ACCURACY OF DIMENSIONS.



14 Belbowrie Avenue

WIR

Width: 1.97 m
Length: 3.40 m
Area: 6.68 m²
Perimeter: 10.73 m

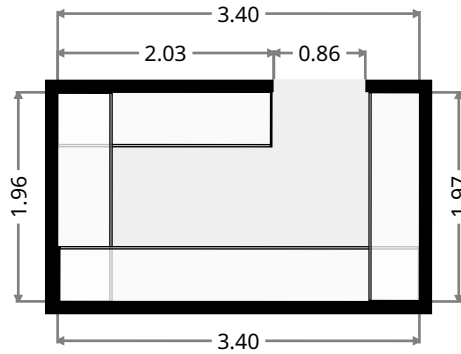
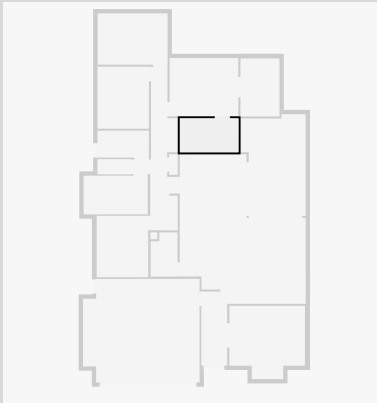

Outdoor Area

Width: 3.77 m
Length: 5.89 m
Area: 19.89 m²
Perimeter: 19.33 m

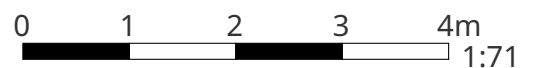
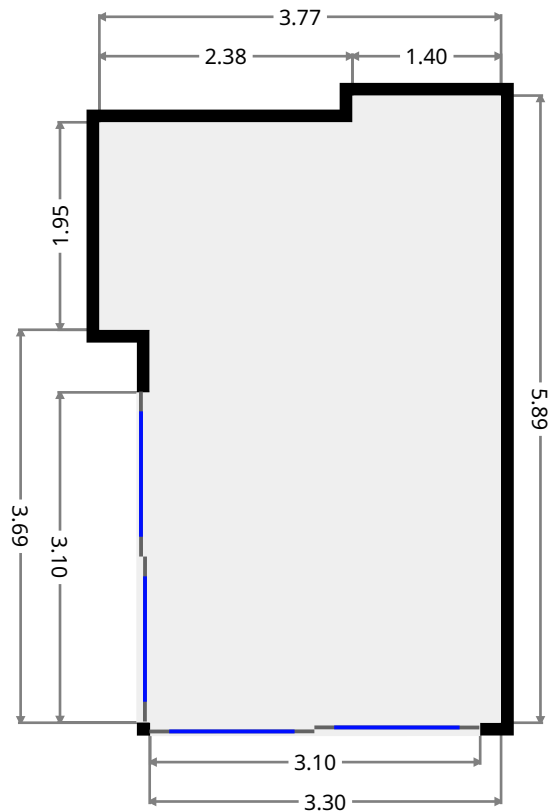
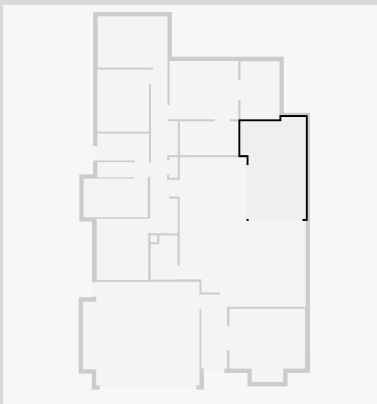

THIS FLOORPLAN IS PROVIDED WITHOUT WARRANTY OF ANY KIND. SENSOPIA DISCLAIMS ANY WARRANTY INCLUDING, WITHOUT LIMITATION, SATISFACTORY QUALITY OR ACCURACY OF DIMENSIONS.

14 Belbowrie Avenue

Bedroom

Width: 2.98 m
Length: 3.57 m
Area: 10.62 m²
Perimeter: 13.09 m

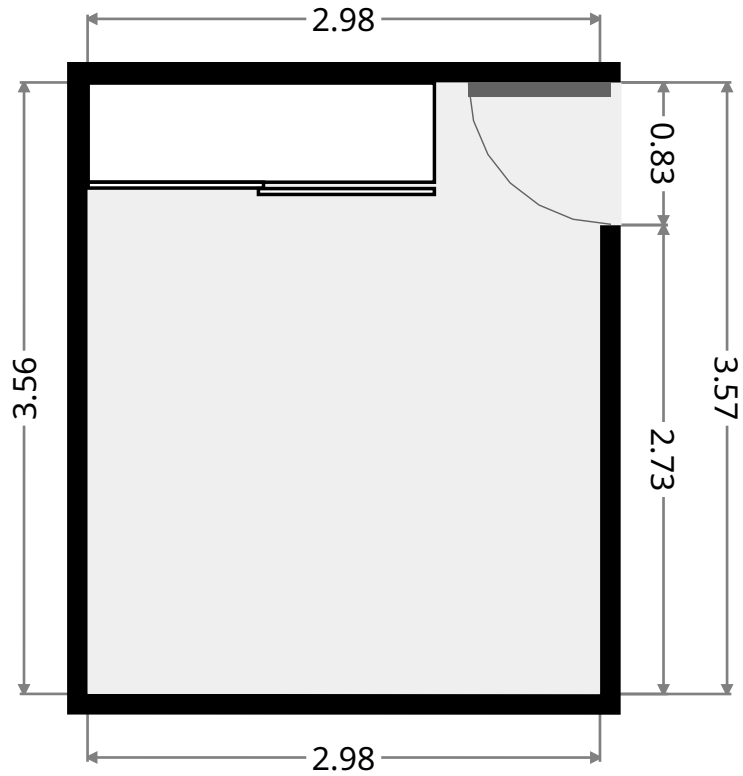
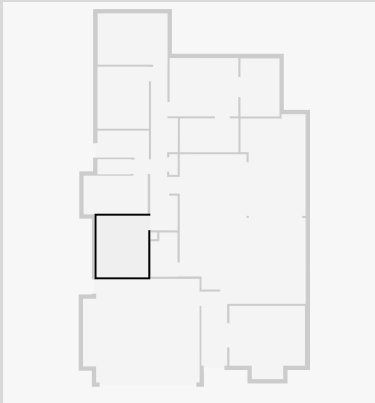

Bathroom

Width: 2.25 m
Length: 3.72 m
Area: 8.33 m²
Perimeter: 11.92 m

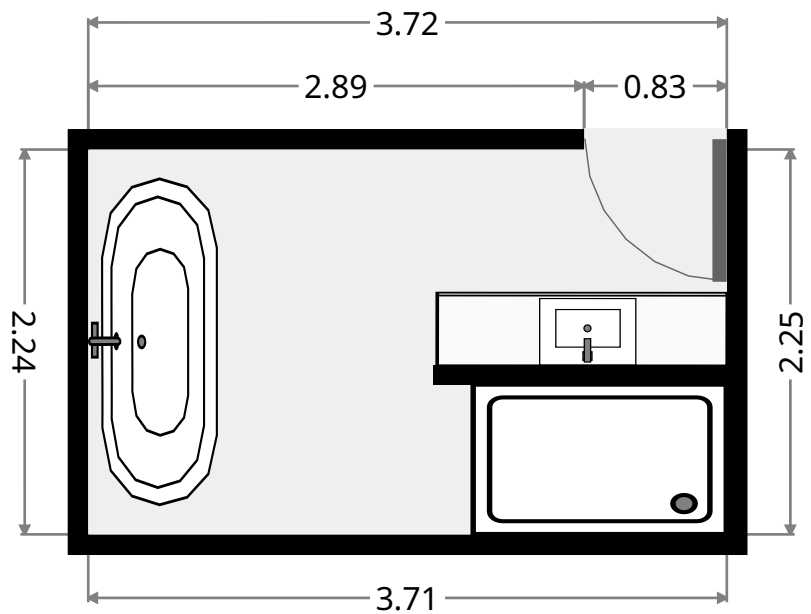
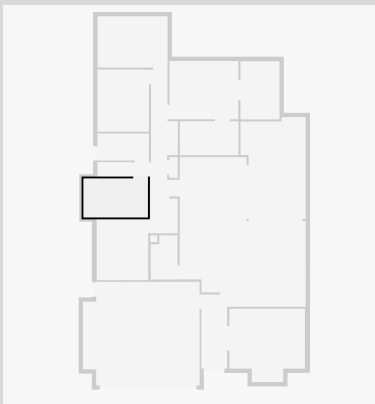

14 Belbowrie Avenue

Toilet

Width: 0.89 m
Length: 1.95 m
Area: 1.72 m²
Perimeter: 5.66 m

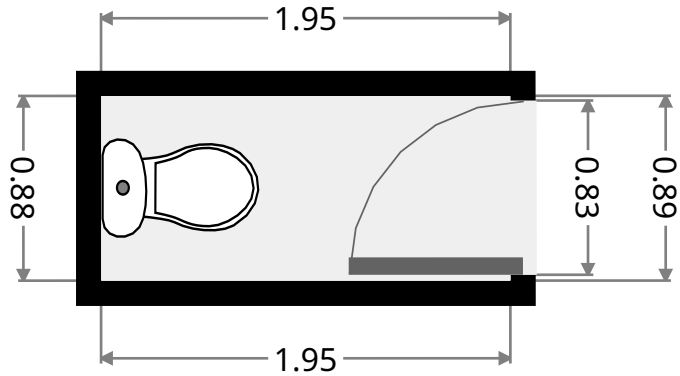
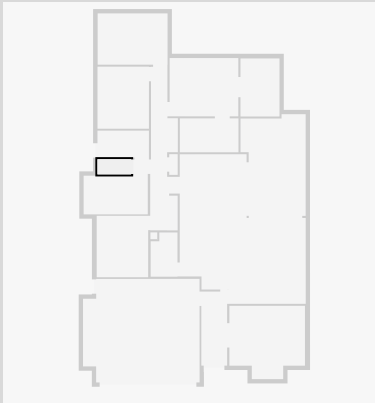

Laundry Room

Width: 1.57 m
Length: 2.98 m
Area: 4.66 m²
Perimeter: 9.08 m

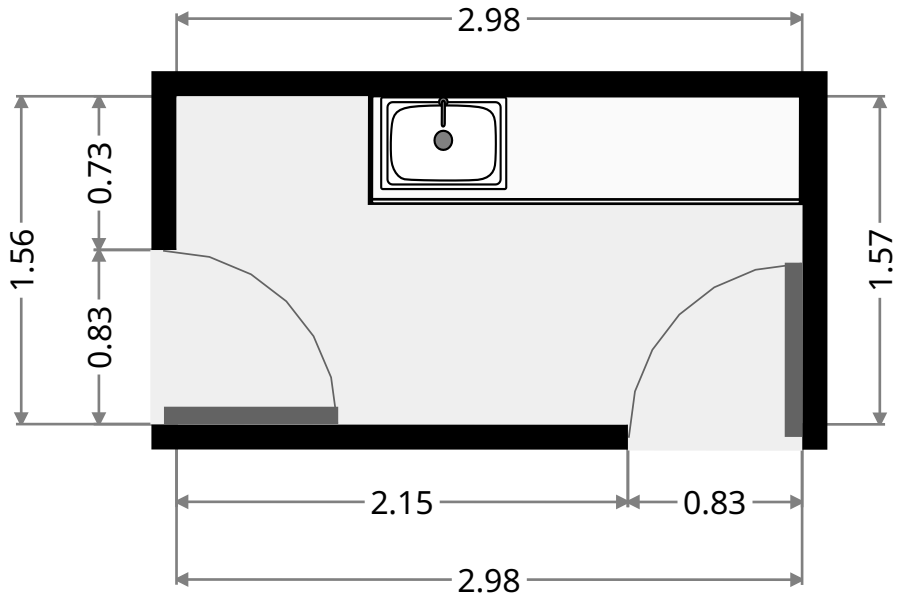
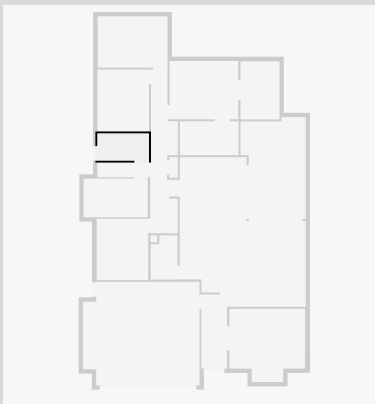

14 Belbowrie Avenue

Bedroom

Width: 2.97 m
 Length: 4.05 m
 Area: 12.03 m²
 Perimeter: 14.04 m

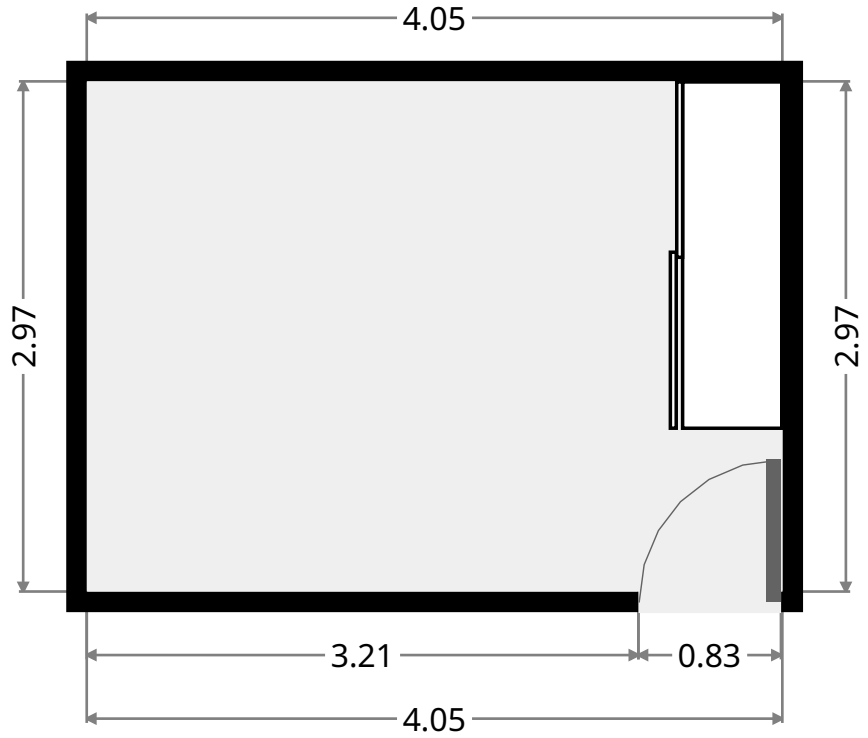
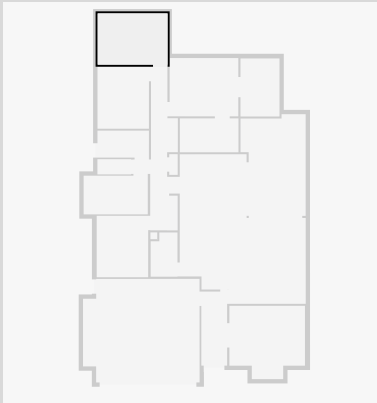

Bedroom

Width: 2.98 m
 Length: 3.60 m
 Area: 10.72 m²
 Perimeter: 13.15 m

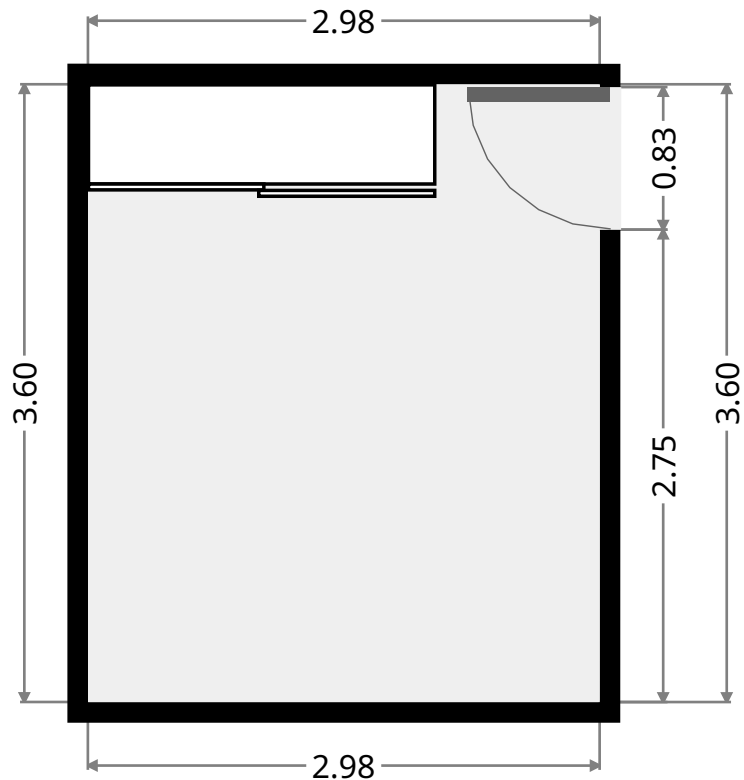
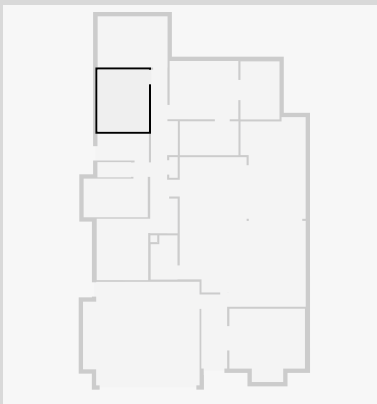

THIS FLOORPLAN IS PROVIDED WITHOUT WARRANTY OF ANY KIND. SENSOPIA DISCLAIMS ANY WARRANTY INCLUDING, WITHOUT LIMITATION, SATISFACTORY QUALITY OR ACCURACY OF DIMENSIONS.

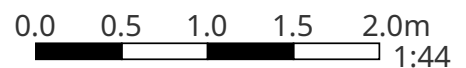

14 Belbowrie Avenue

Ensuite

Width: 2.26 m
Length: 3.36 m
Area: 7.60 m²
Perimeter: 11.24 m

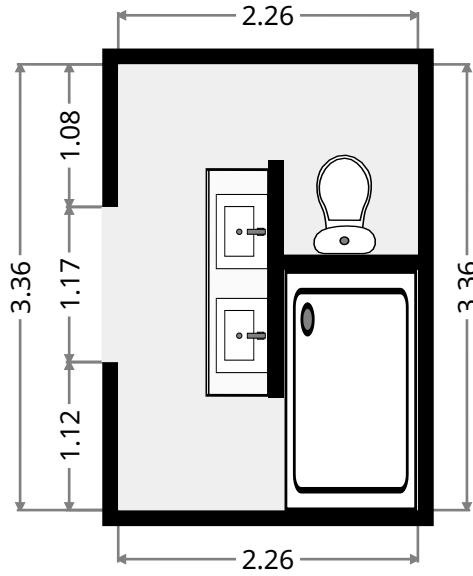
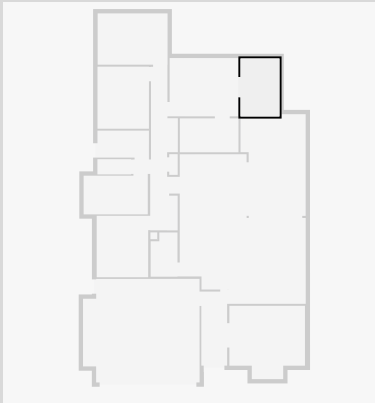

Hall

Width: 1.50 m
Length: 4.29 m
Area: 6.42 m²
Perimeter: 11.58 m

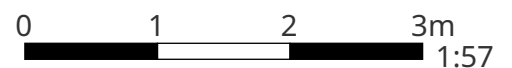
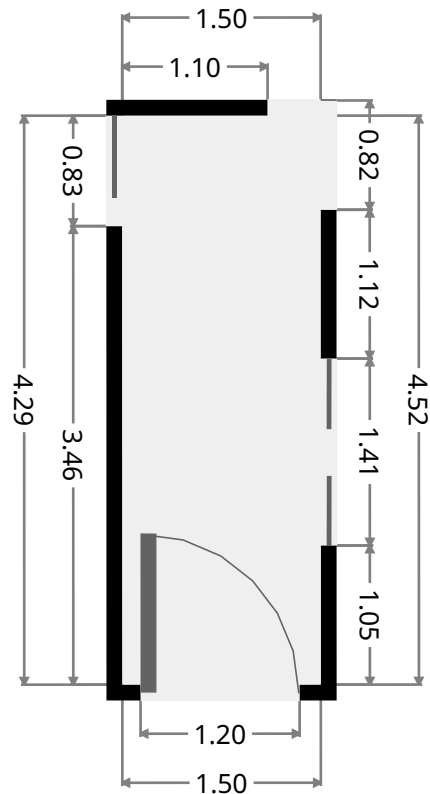
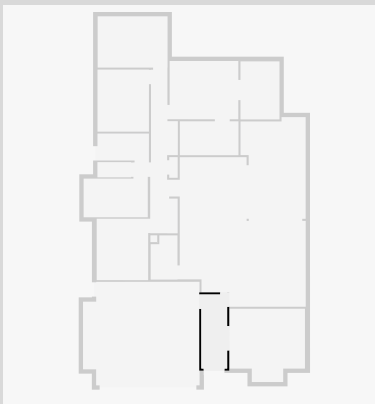

14 Belbowrie Avenue

Master Bedroom

Width: 3.38 m
 Length: 3.98 m
 Area: 13.44 m²
 Perimeter: 14.72 m

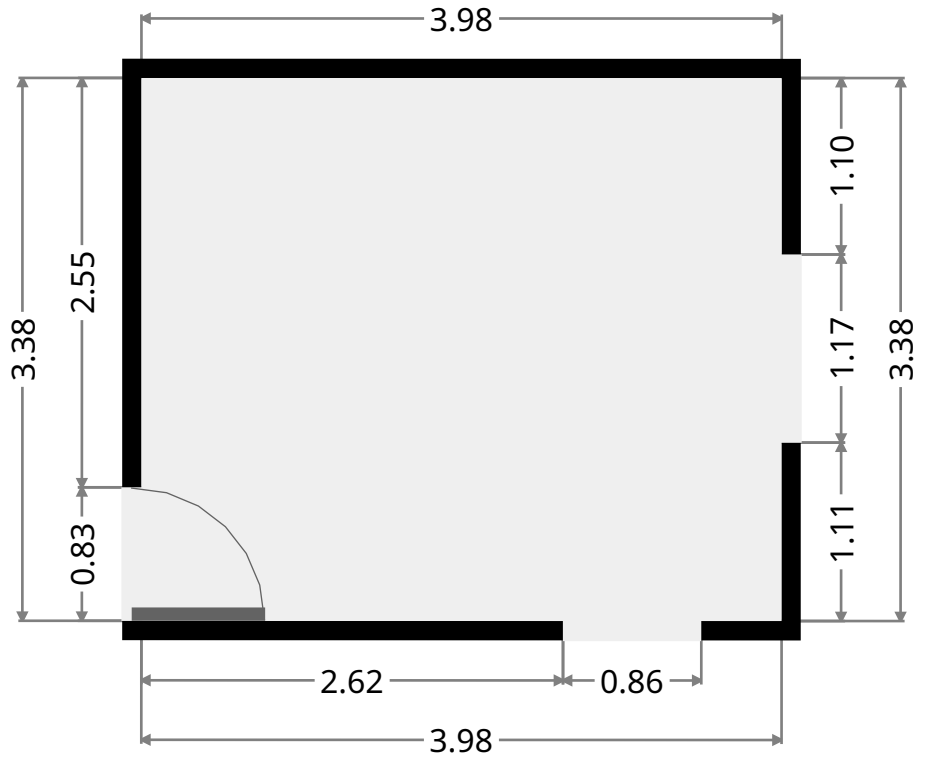
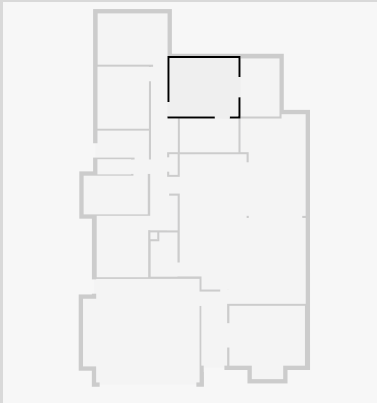

Closet

Width: 0.49 m
 Length: 1.20 m
 Area: 0.59 m²
 Perimeter: 3.38 m

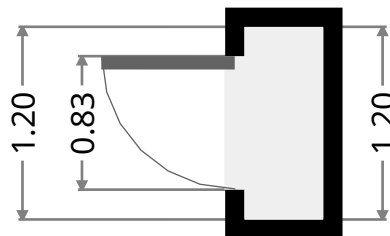
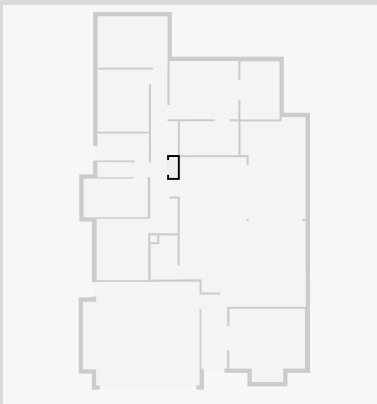

14 Belbowrie Avenue

Study

Width: 0.49 m
Length: 2.01 m
Area: 0.99 m²
Perimeter: 5.01 m

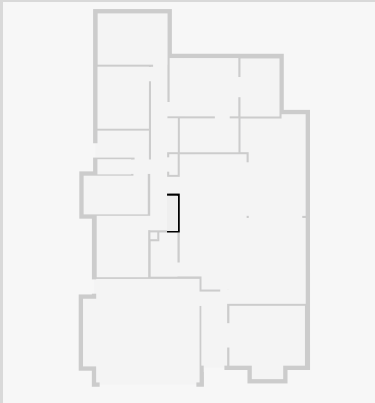

Hall

Width: 2.59 m
Length: 9.47 m
Area: 11.72 m²
Perimeter: 25.33 m

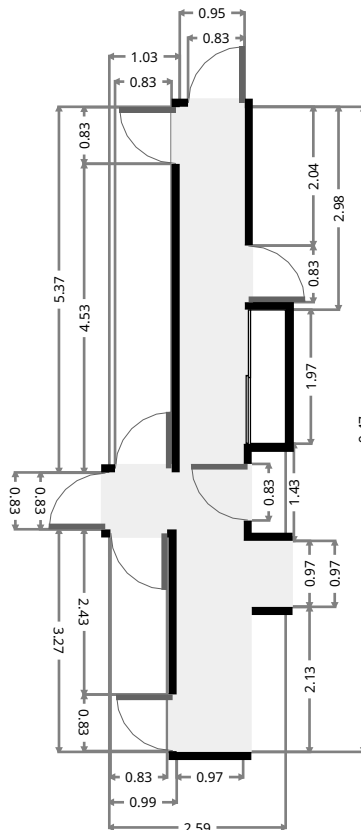
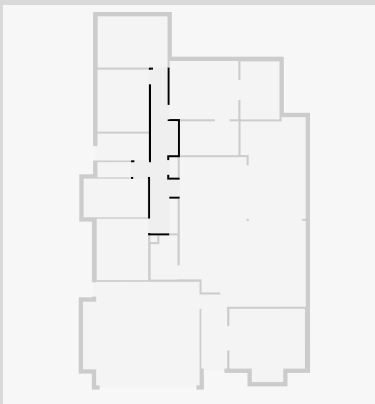

0 2 4 6m
1:111

14 Belbowrie Avenue

Pantry

Width: 1.55 m
 Length: 2.56 m
 Area: 3.72 m²
 Perimeter: 8.23 m

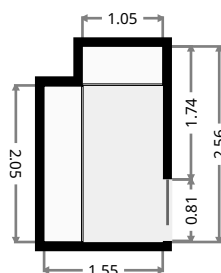
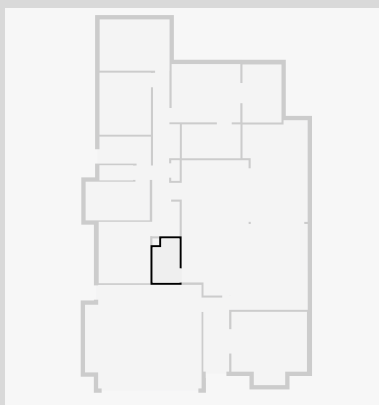

Kitchen/Living/Dining

Width: 7.30 m
 Length: 8.67 m
 Area: 47.30 m²
 Perimeter: 31.93 m

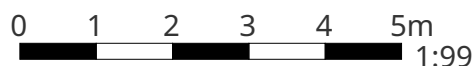
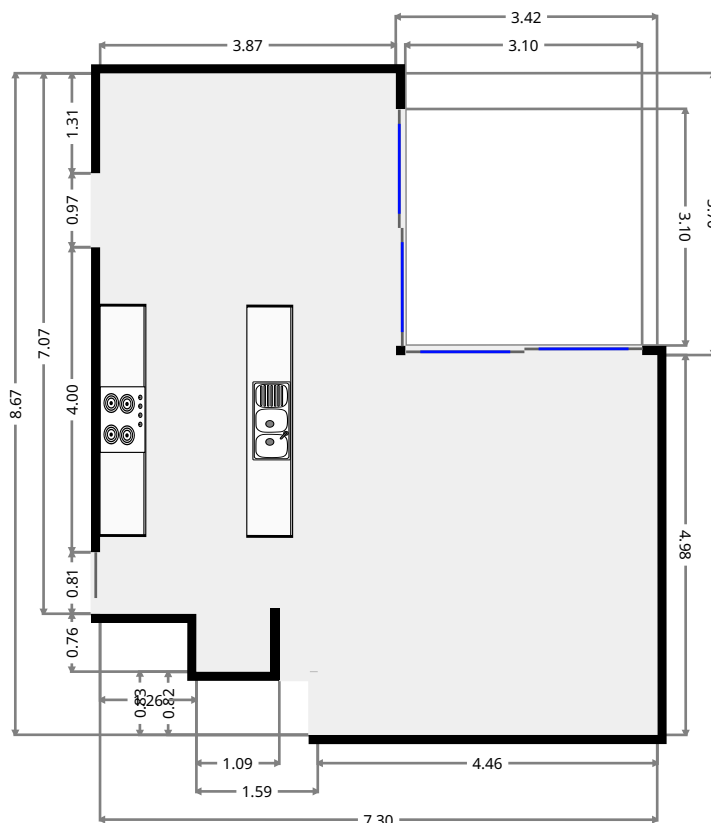
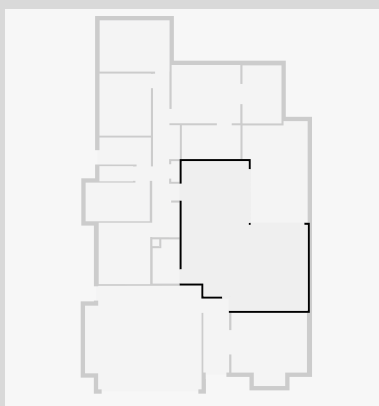

THIS FLOORPLAN IS PROVIDED WITHOUT WARRANTY OF ANY KIND. SENSOPIA DISCLAIMS ANY WARRANTY INCLUDING, WITHOUT LIMITATION, SATISFACTORY QUALITY OR ACCURACY OF DIMENSIONS.

14 Belbowrie Avenue

Garage

Width: 6.00 m
 Length: 6.75 m
 Area: 38.93 m²
 Perimeter: 25.51 m

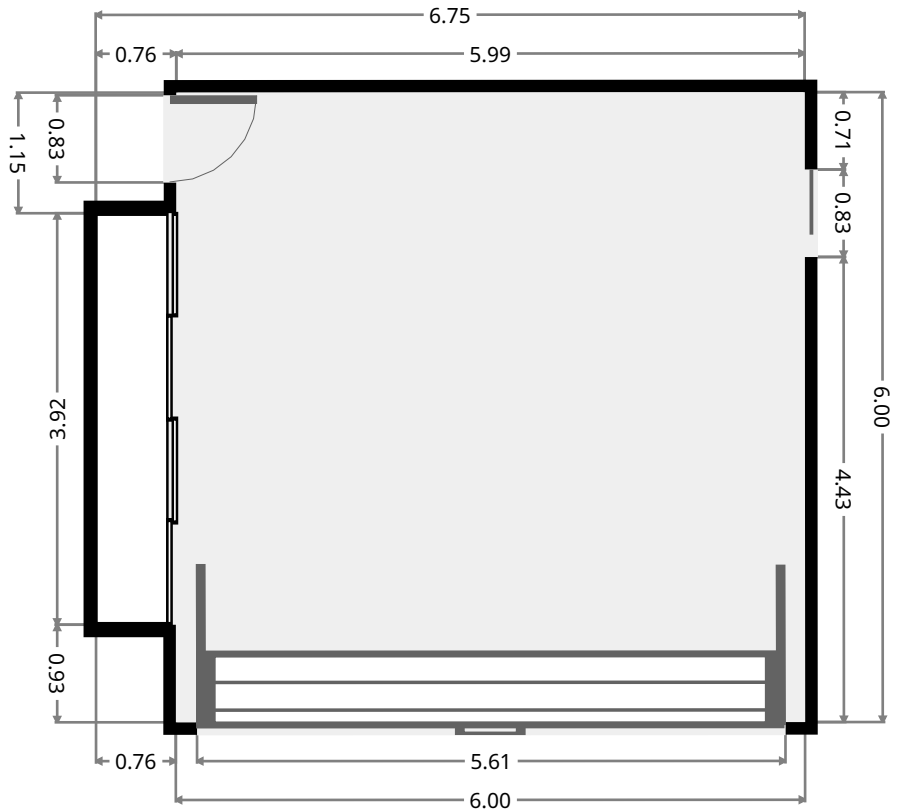
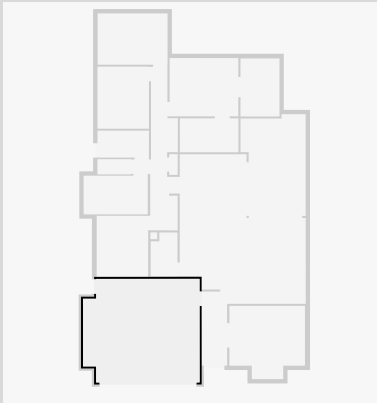

Media Room

Width: 4.25 m
 Length: 4.37 m
 Area: 16.60 m²
 Perimeter: 17.25 m

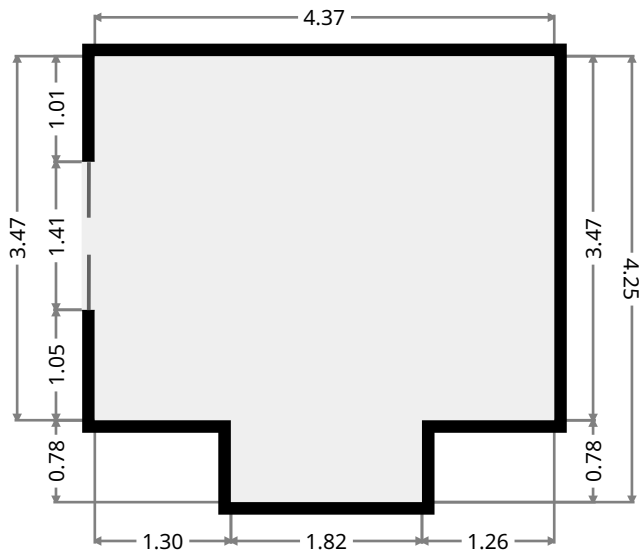
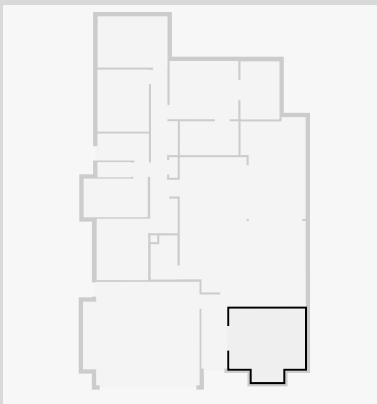

THIS FLOORPLAN IS PROVIDED WITHOUT WARRANTY OF ANY KIND. SENSOPIA DISCLAIMS ANY WARRANTY INCLUDING, WITHOUT LIMITATION, SATISFACTORY QUALITY OR ACCURACY OF DIMENSIONS.

