

14 Africander Avenue

Ground Floor

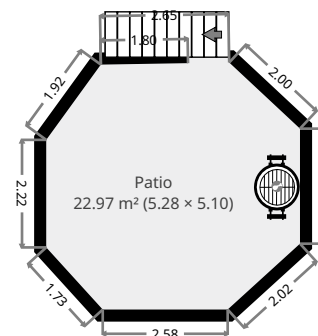

THIS FLOORPLAN IS PROVIDED WITHOUT WARRANTY OF ANY KIND. SENSOPIA DISCLAIMS ANY WARRANTY INCLUDING, WITHOUT LIMITATION, SATISFACTORY QUALITY OR ACCURACY OF DIMENSIONS.

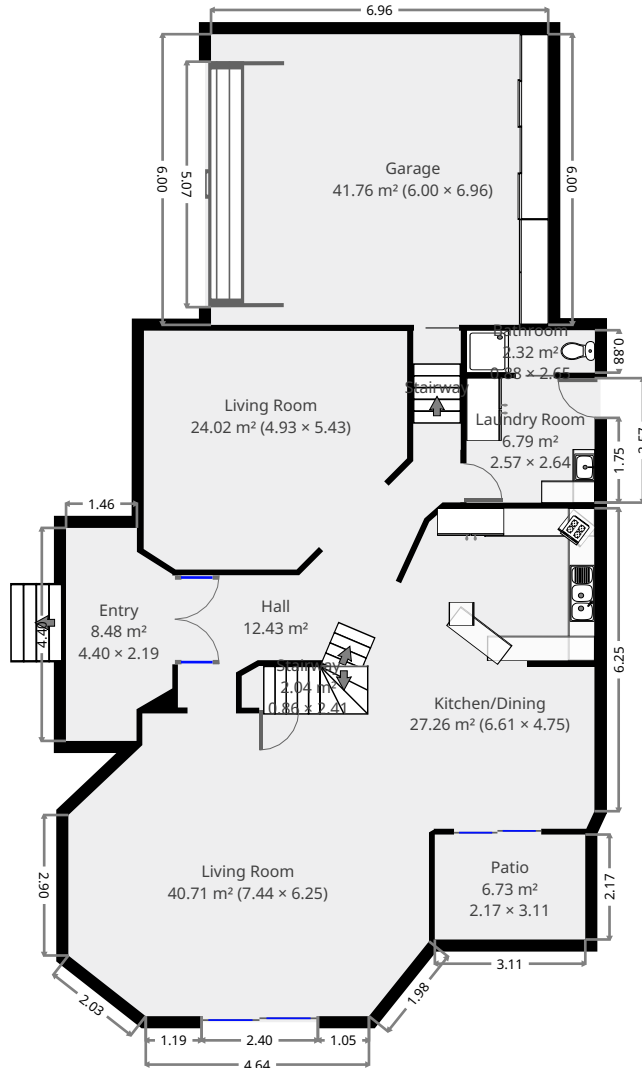

14 Africander Avenue

Living Room

Width: 6.25 m
 Length: 7.44 m
 Area: 40.71 m²
 Perimeter: 23.85 m

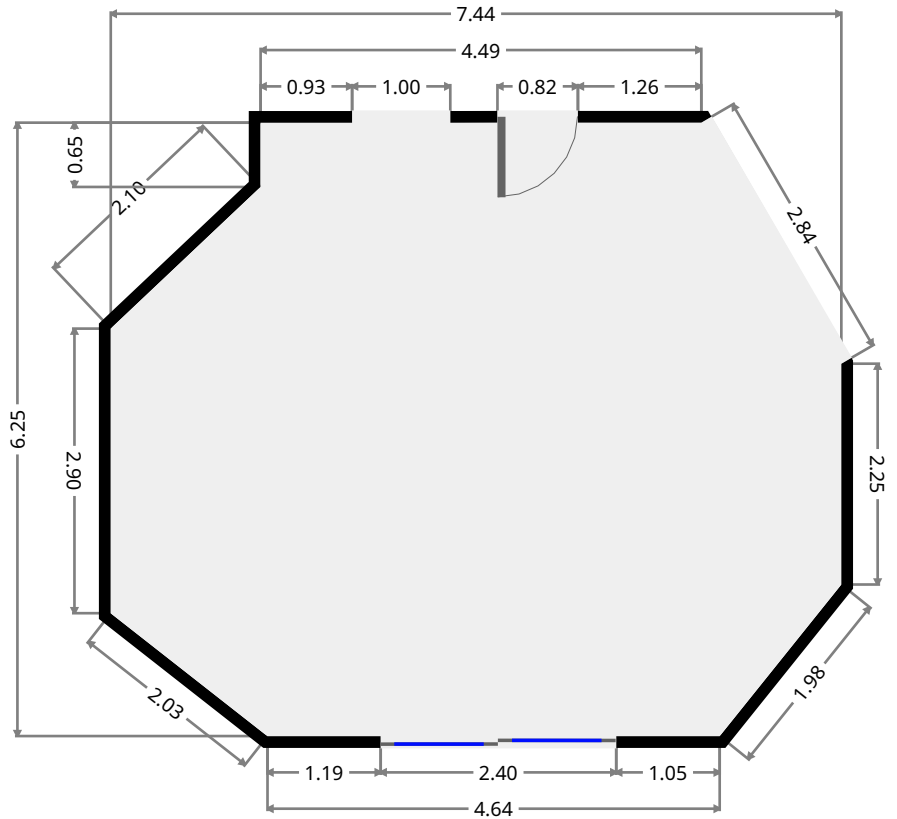
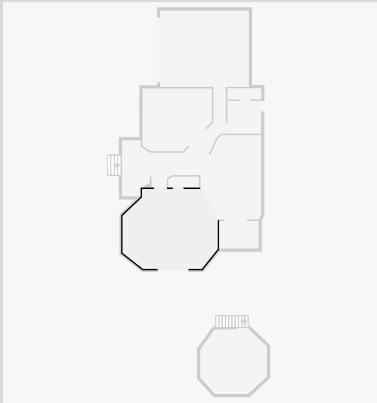

Hall

Width: 1.03 m
 Length: 3.33 m
 Area: 12.43 m²
 Perimeter: 19.48 m

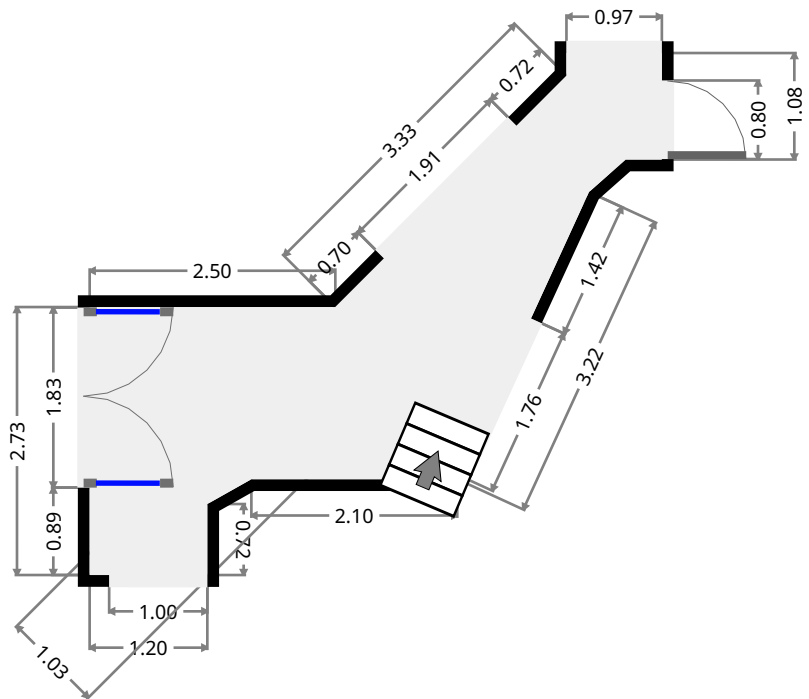
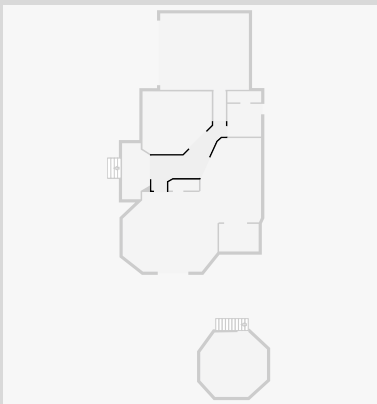

THIS FLOORPLAN IS PROVIDED WITHOUT WARRANTY OF ANY KIND. SENSOPIA DISCLAIMS ANY WARRANTY INCLUDING, WITHOUT LIMITATION, SATISFACTORY QUALITY OR ACCURACY OF DIMENSIONS.

14 Africander Avenue

Stairway

Width: 0.86 m
 Length: 2.41 m
 Area: 2.04 m²
 Perimeter: 6.39 m

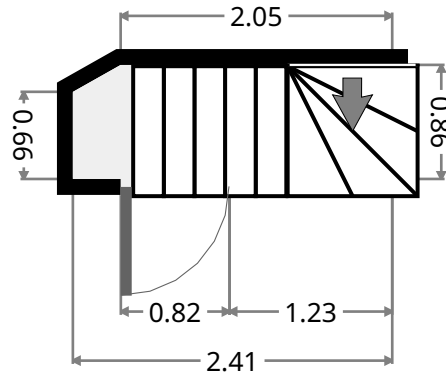
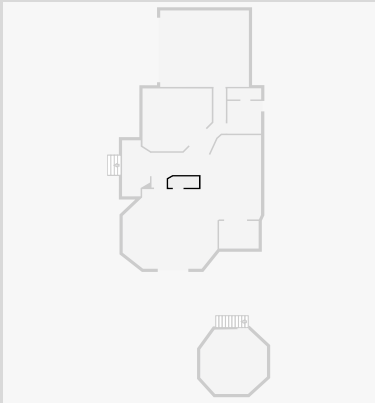

Living Room

Width: 4.93 m
 Length: 5.43 m
 Area: 24.02 m²
 Perimeter: 19.09 m

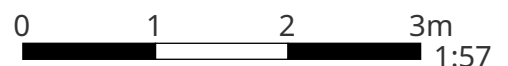
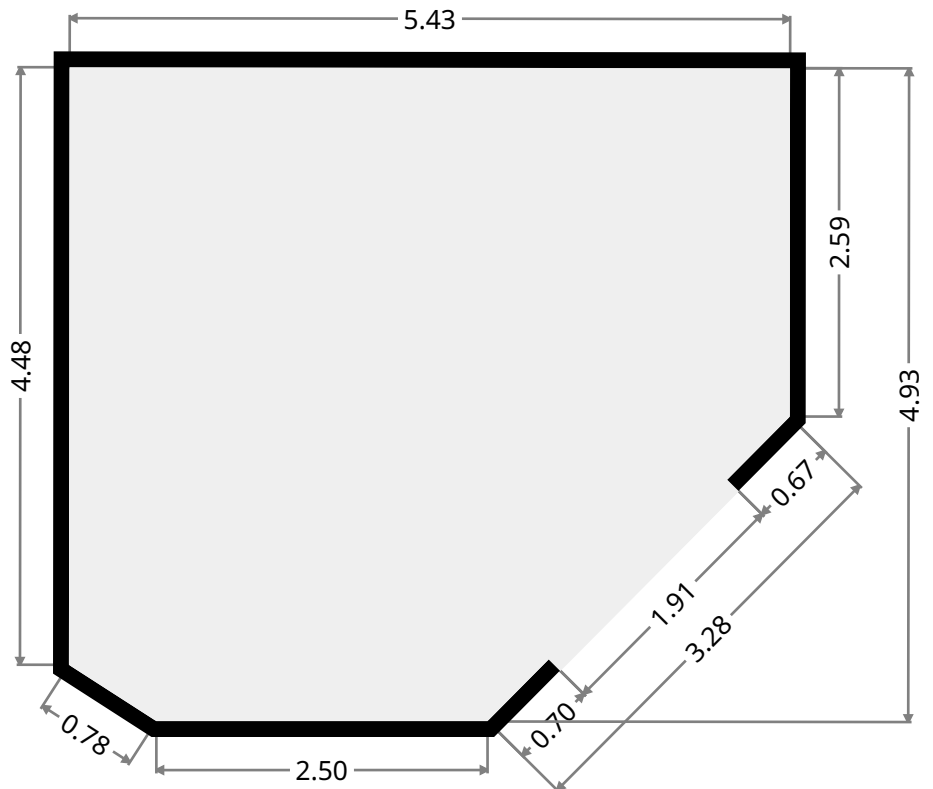
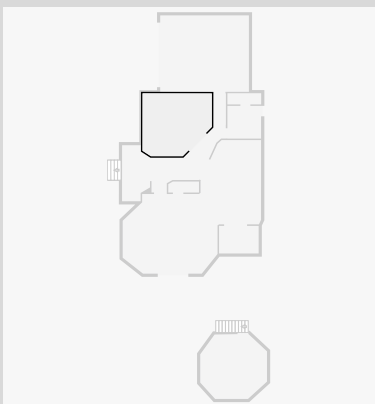

THIS FLOORPLAN IS PROVIDED WITHOUT WARRANTY OF ANY KIND. SENSOPIA DISCLAIMS ANY WARRANTY INCLUDING, WITHOUT LIMITATION, SATISFACTORY QUALITY OR ACCURACY OF DIMENSIONS.

14 Africander Avenue

Stairway

Width: 0.98 m
 Length: 2.34 m
 Area: 2.29 m²
 Perimeter: 6.64 m

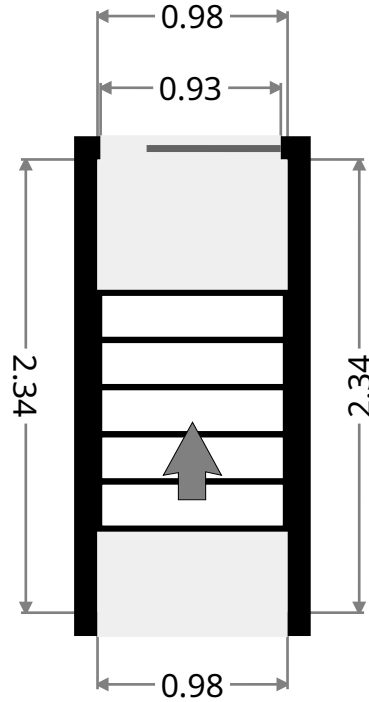
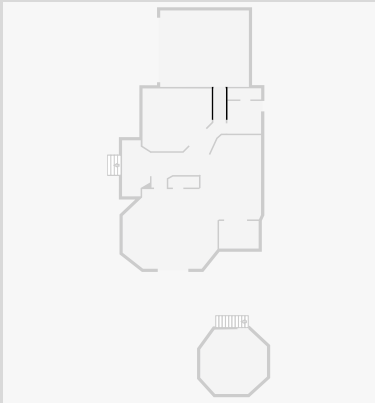

Laundry Room

Width: 2.57 m
 Length: 2.64 m
 Area: 6.79 m²
 Perimeter: 10.42 m

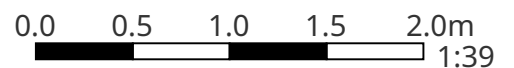
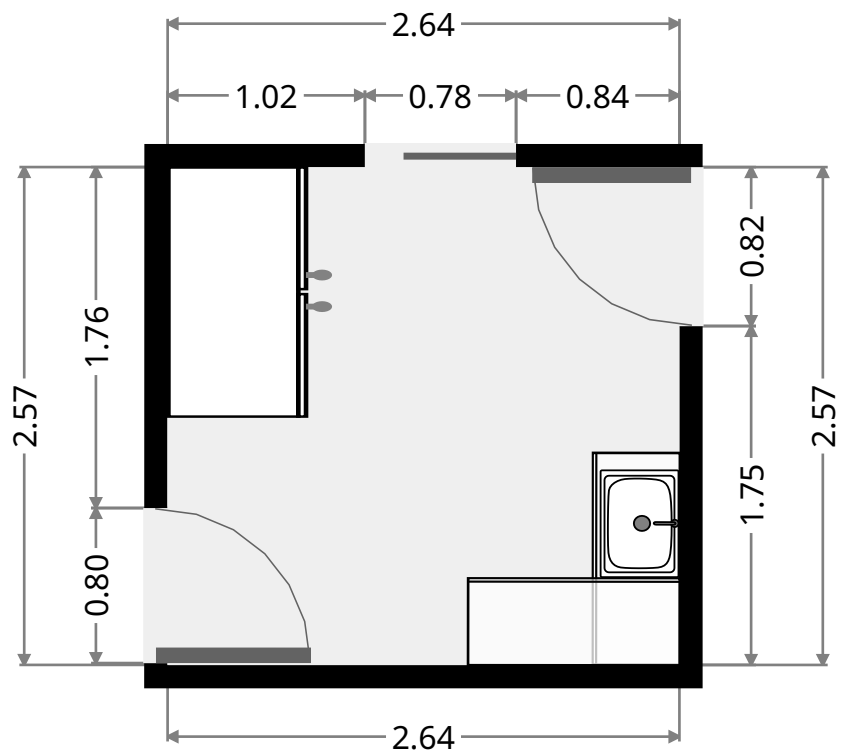
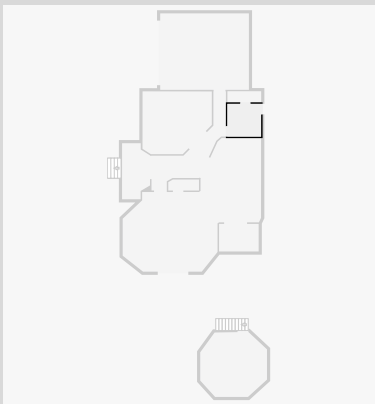

THIS FLOORPLAN IS PROVIDED WITHOUT WARRANTY OF ANY KIND. SENSOPIA DISCLAIMS ANY WARRANTY INCLUDING, WITHOUT LIMITATION, SATISFACTORY QUALITY OR ACCURACY OF DIMENSIONS.

14 Africander Avenue

Bathroom

Width: 0.88 m
Length: 2.65 m
Area: 2.32 m²
Perimeter: 7.05 m

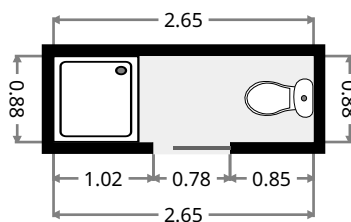
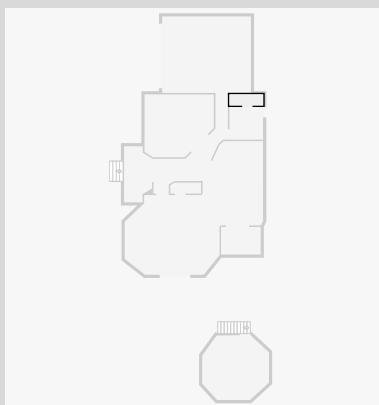

Kitchen/Dining

Width: 4.75 m
Length: 6.61 m
Area: 27.26 m²
Perimeter: 20.33 m

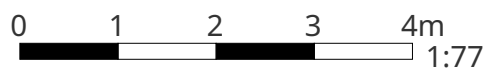
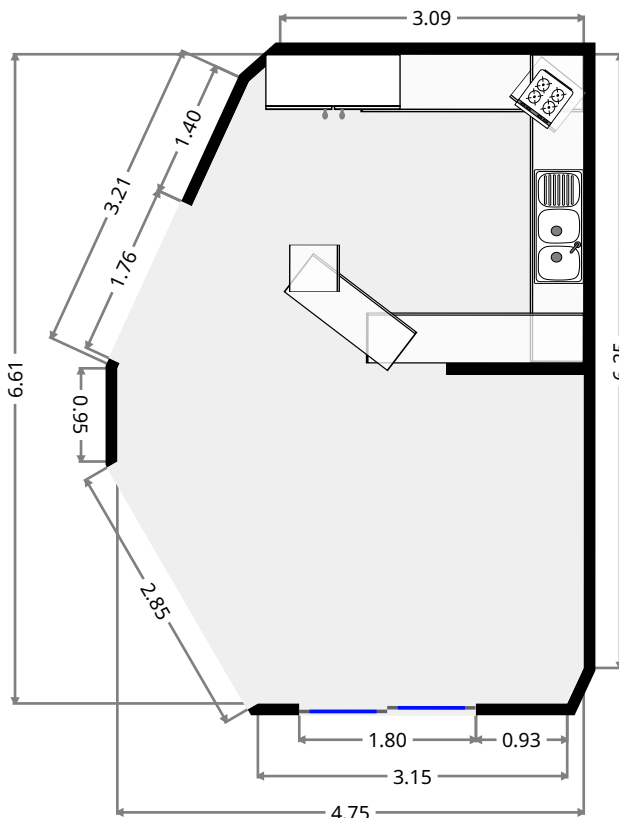
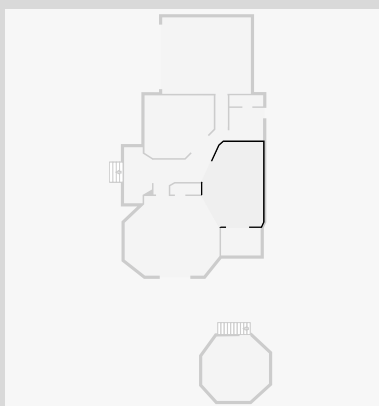

THIS FLOORPLAN IS PROVIDED WITHOUT WARRANTY OF ANY KIND. SENSOPIA DISCLAIMS ANY WARRANTY INCLUDING, WITHOUT LIMITATION, SATISFACTORY QUALITY OR ACCURACY OF DIMENSIONS.

14 Africander Avenue

Garage

Width: 6.00 m
Length: 6.96 m
Area: 41.76 m²
Perimeter: 25.92 m

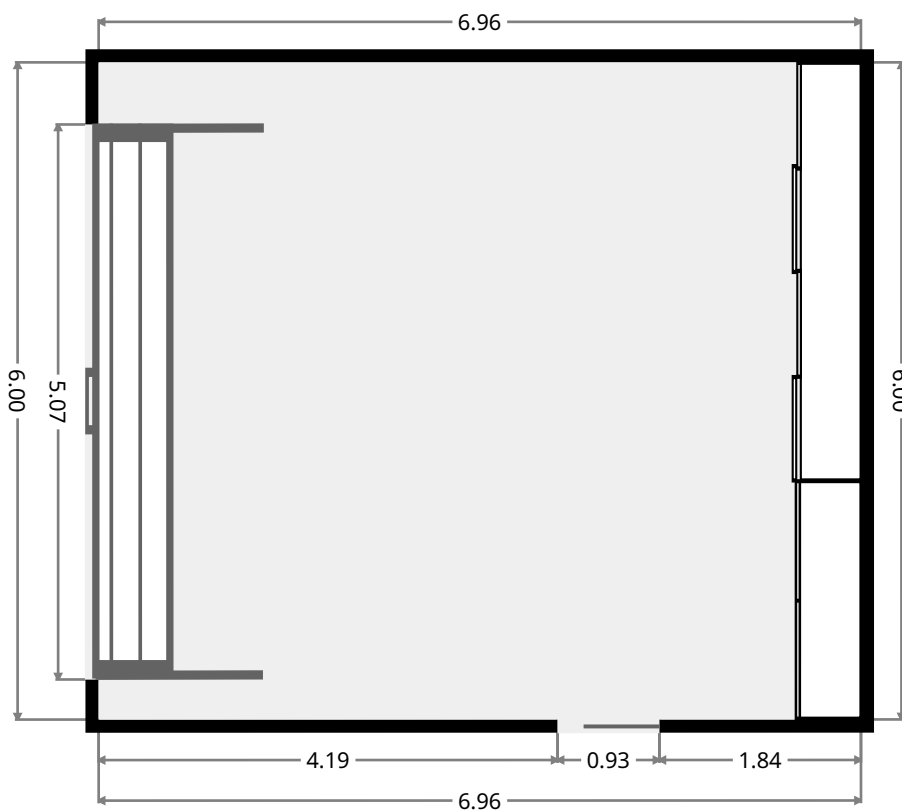
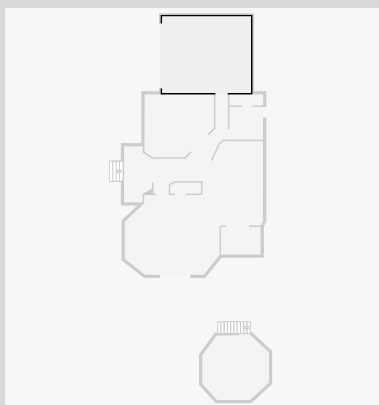

Patio

Width: 2.17 m
Length: 3.11 m
Area: 6.73 m²
Perimeter: 10.54 m

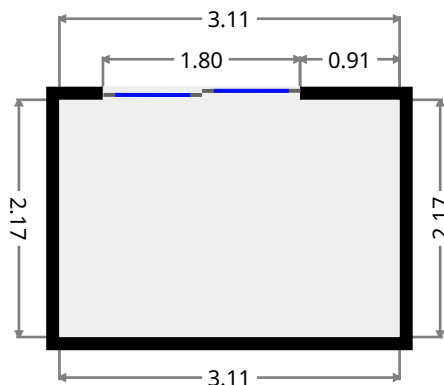
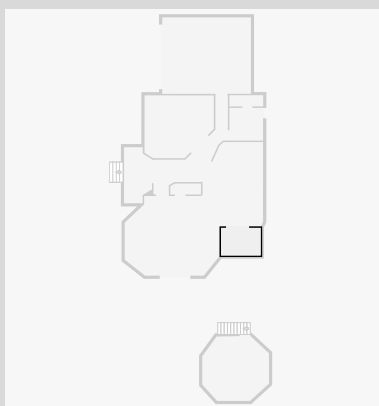

14 Africander Avenue

Patio

Width: 5.10 m
 Length: 5.28 m
 Area: 22.97 m²
 Perimeter: 17.50 m

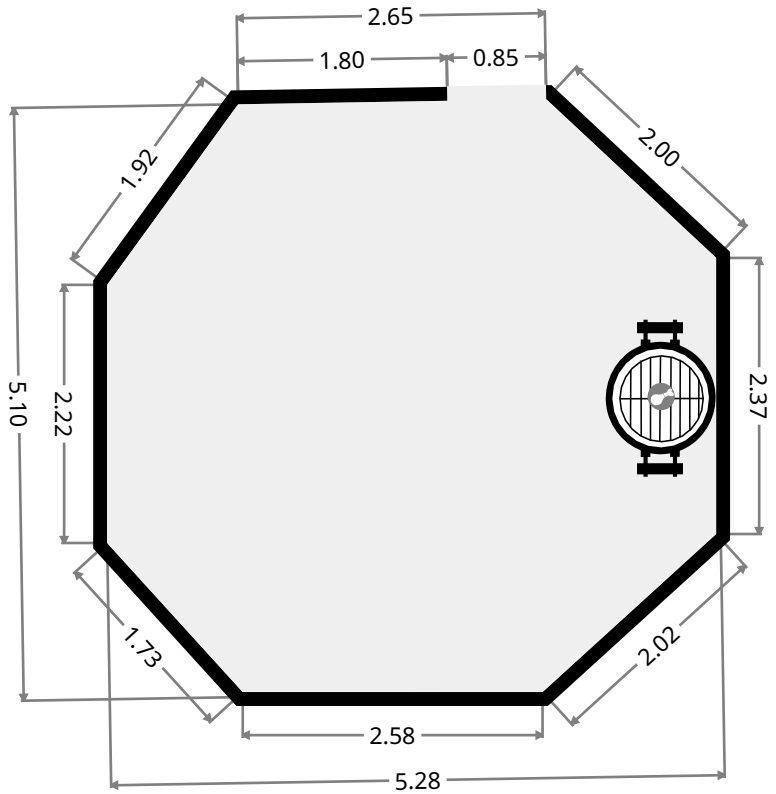
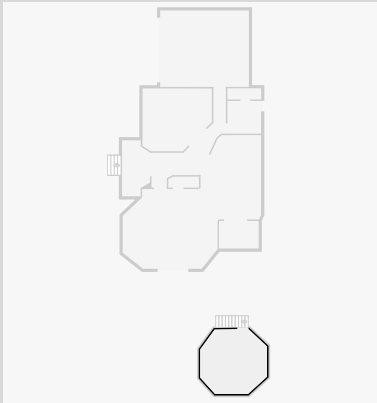

Entry

Width: 2.19 m
 Length: 4.40 m
 Area: 8.48 m²
 Perimeter: 12.54 m

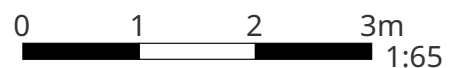
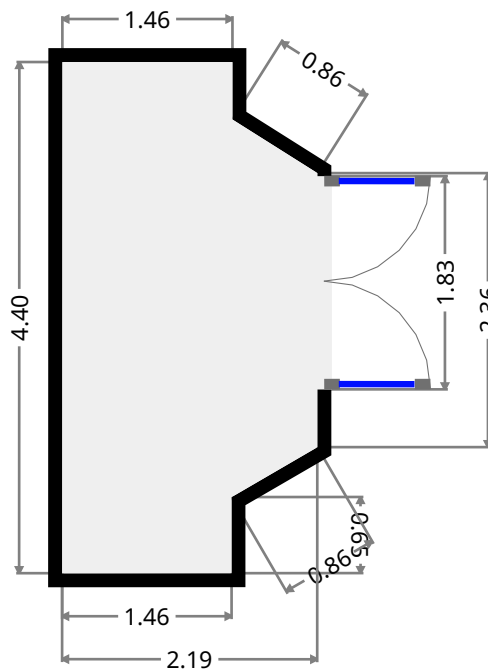
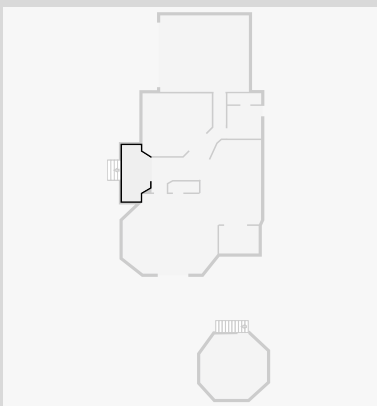

THIS FLOORPLAN IS PROVIDED WITHOUT WARRANTY OF ANY KIND. SENSOPIA DISCLAIMS ANY WARRANTY INCLUDING, WITHOUT LIMITATION, SATISFACTORY QUALITY OR ACCURACY OF DIMENSIONS.

14 Africander Avenue

1st Floor

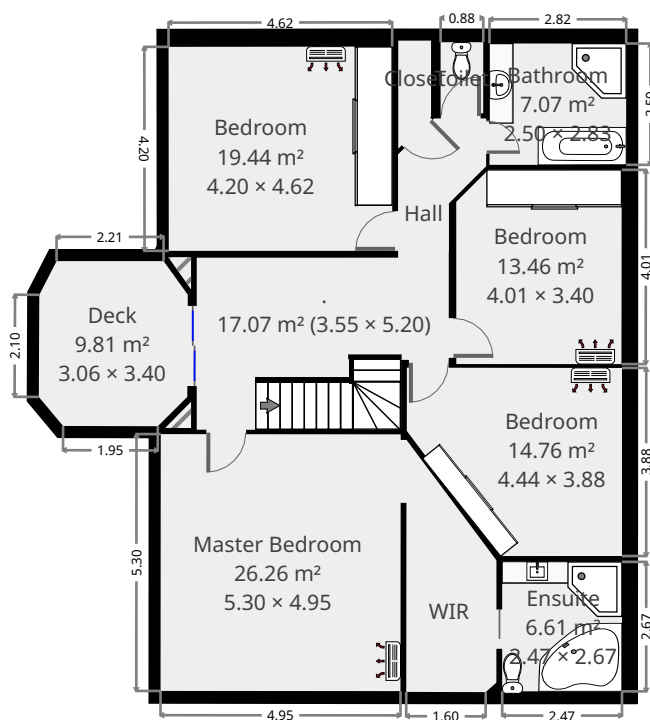

THIS FLOORPLAN IS PROVIDED WITHOUT WARRANTY OF ANY KIND. SENSOPIA DISCLAIMS ANY WARRANTY INCLUDING, WITHOUT LIMITATION, SATISFACTORY QUALITY OR ACCURACY OF DIMENSIONS.



14 Africander Avenue

•
 Width: 3.55 m
 Length: 5.20 m
 Area: 17.07 m²
 Perimeter: 17.51 m

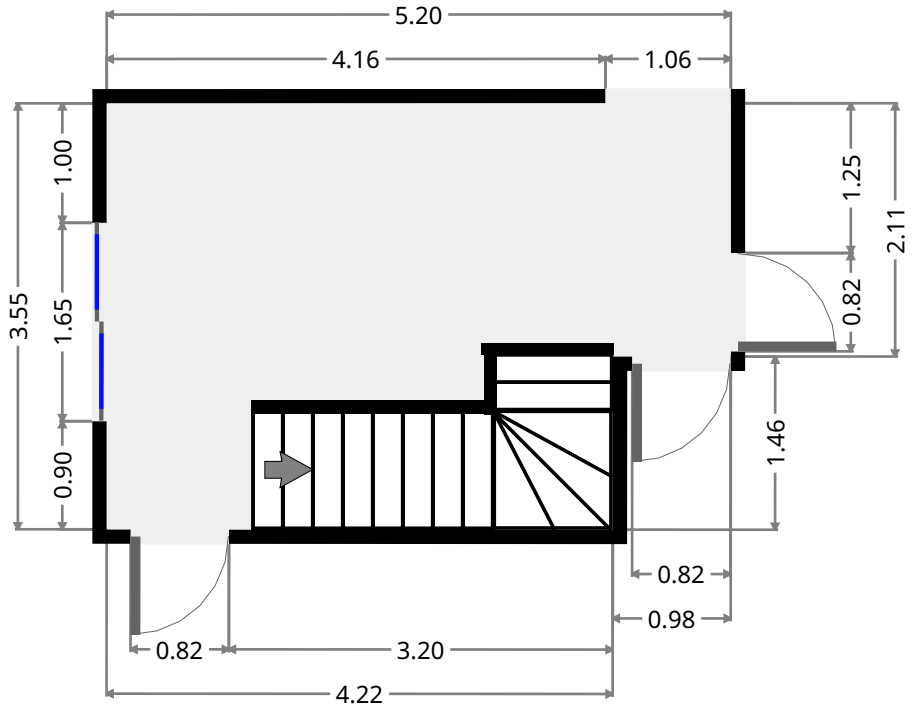
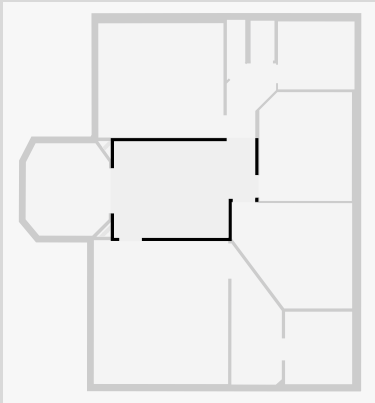

Master Bedroom

Width: 4.95 m
 Length: 5.30 m
 Area: 26.26 m²
 Perimeter: 20.51 m

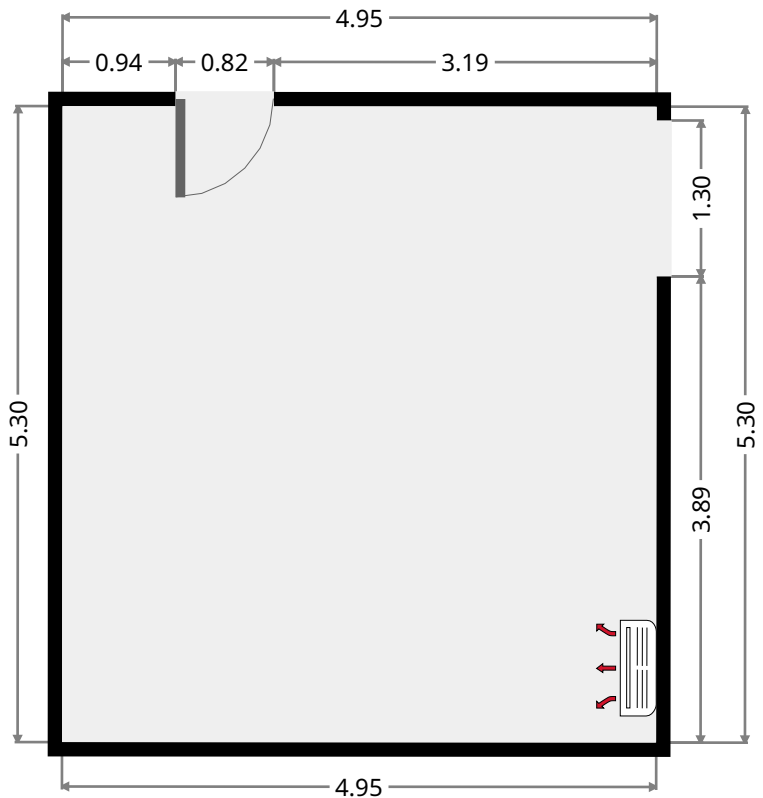
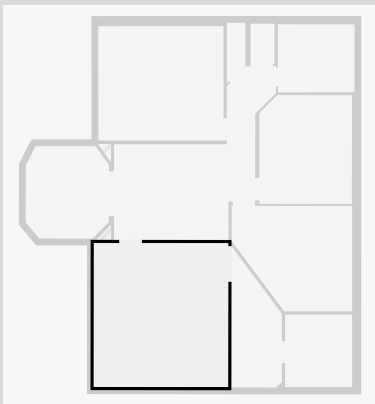

THIS FLOORPLAN IS PROVIDED WITHOUT WARRANTY OF ANY KIND. SENSOPIA DISCLAIMS ANY WARRANTY INCLUDING, WITHOUT LIMITATION, SATISFACTORY QUALITY OR ACCURACY OF DIMENSIONS.

14 Africander Avenue

Ensuite

Width: 2.47 m
 Length: 2.67 m
 Area: 6.61 m²
 Perimeter: 10.29 m

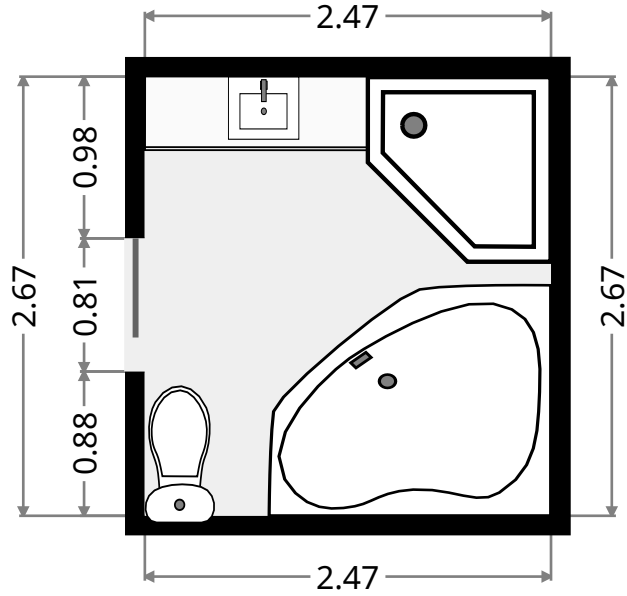
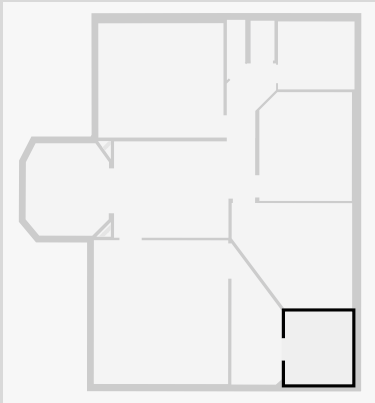

Deck

Width: 3.06 m
 Length: 3.40 m
 Area: 9.81 m²
 Perimeter: 11.66 m

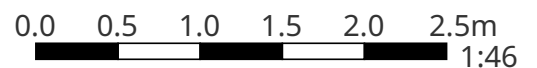
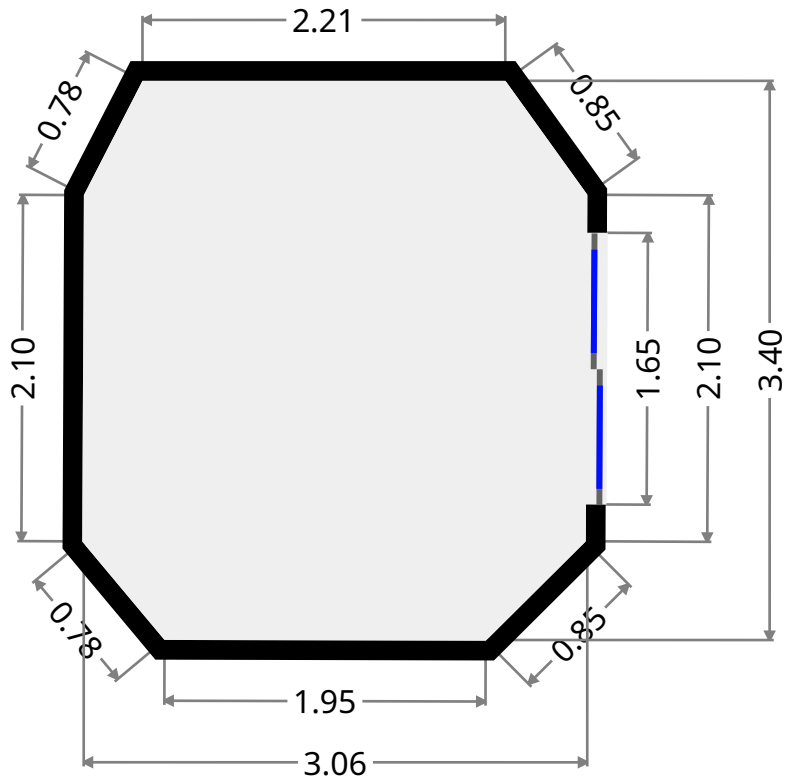
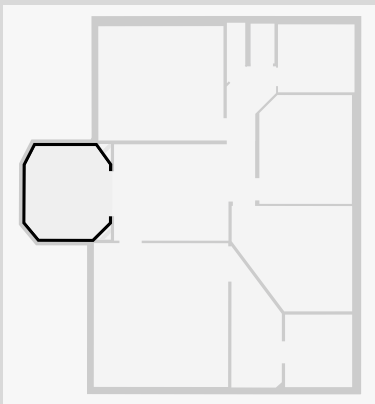

THIS FLOORPLAN IS PROVIDED WITHOUT WARRANTY OF ANY KIND. SENSOPIA DISCLAIMS ANY WARRANTY INCLUDING, WITHOUT LIMITATION, SATISFACTORY QUALITY OR ACCURACY OF DIMENSIONS.

14 Africander Avenue

Hall

Width: 1.82 m
 Length: 2.75 m
 Area: 3.67 m²
 Perimeter: 8.26 m

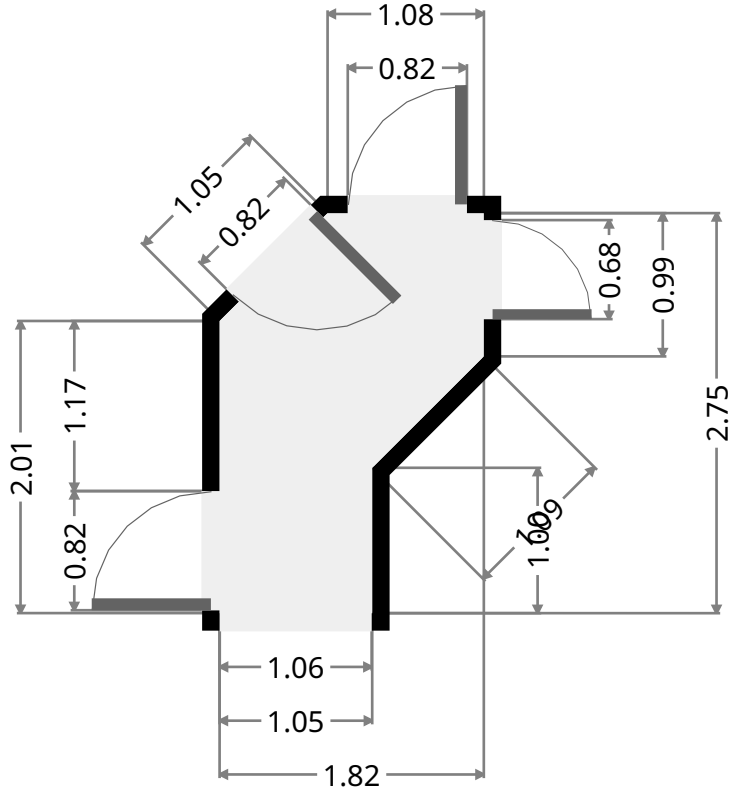
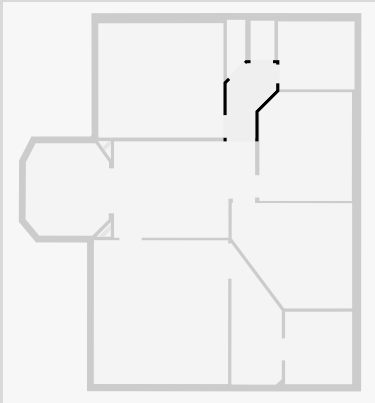

Bathroom

Width: 2.50 m
 Length: 2.83 m
 Area: 7.07 m²
 Perimeter: 10.65 m

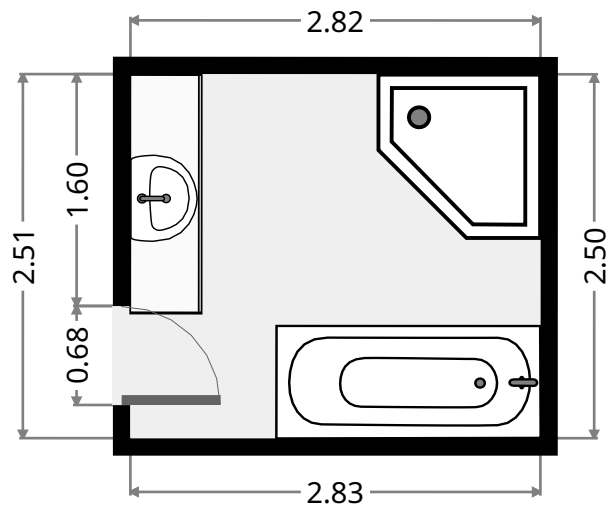
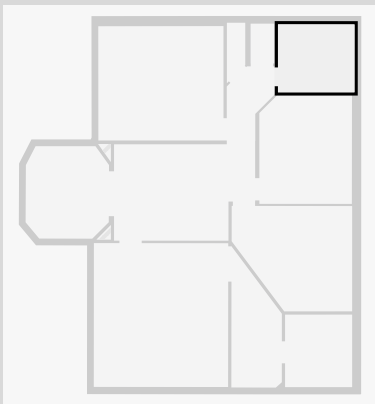

14 Africander Avenue

Toilet / Half Bath

Width: 0.87 m
Length: 1.47 m
Area: 1.29 m²
Perimeter: 4.69 m

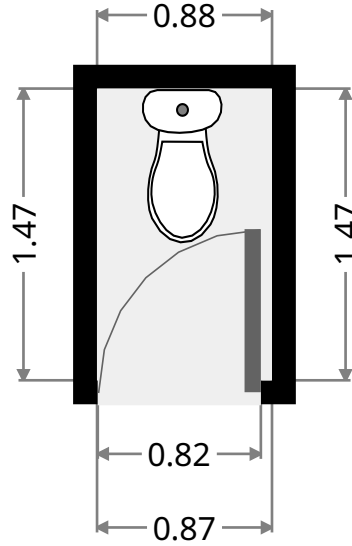
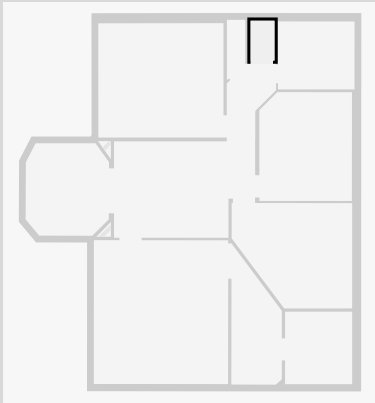

Closet

Width: 0.68 m
Length: 2.23 m
Area: 1.29 m²
Perimeter: 5.42 m

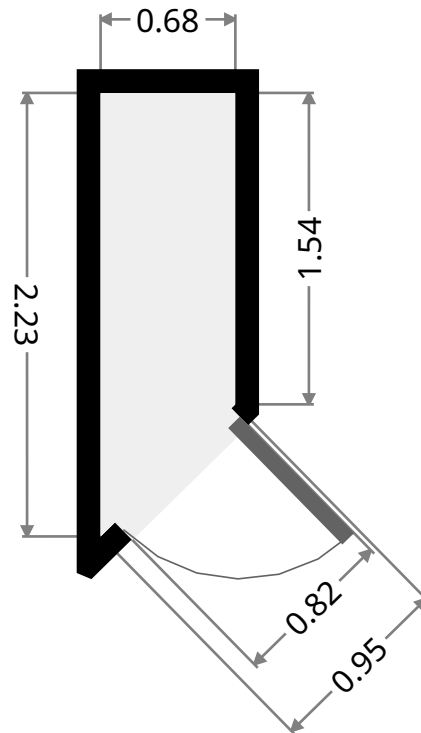
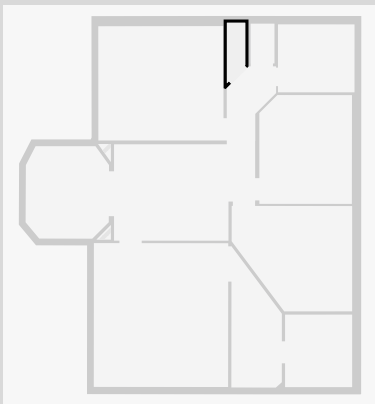

14 Africander Avenue

Bedroom

Width: 4.20 m
 Length: 4.62 m
 Area: 19.44 m²
 Perimeter: 17.66 m

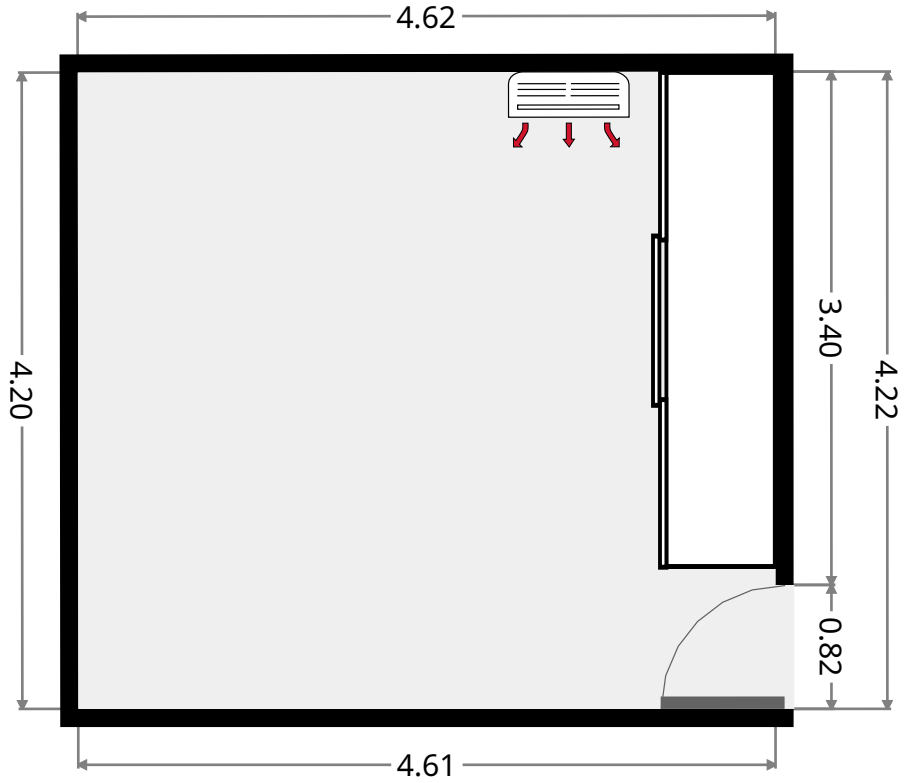
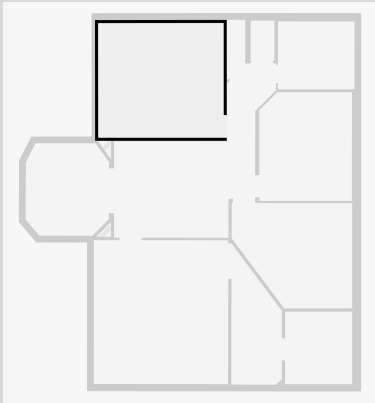

Bedroom

Width: 3.40 m
 Length: 4.01 m
 Area: 13.46 m²
 Perimeter: 14.46 m

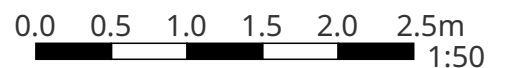
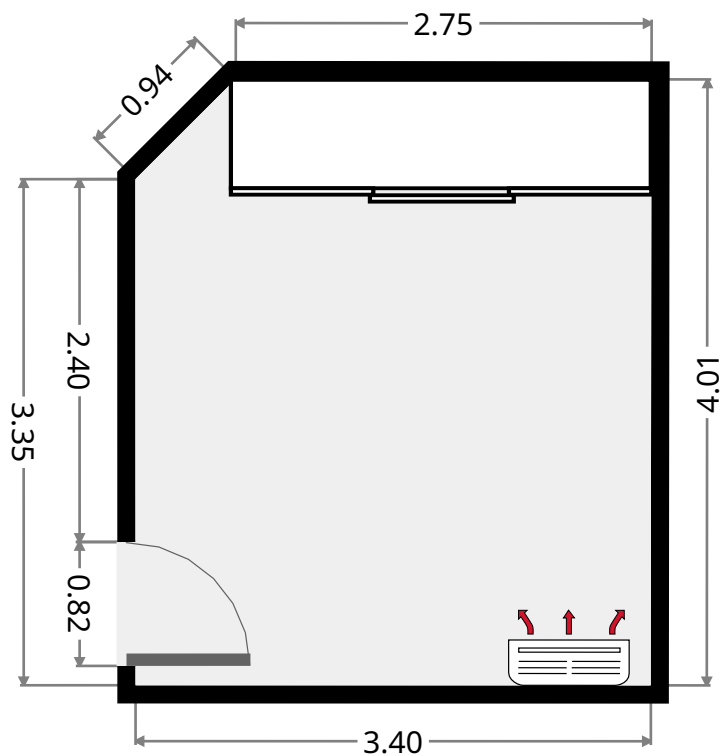
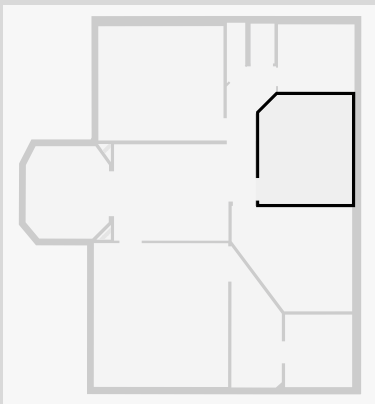

THIS FLOORPLAN IS PROVIDED WITHOUT WARRANTY OF ANY KIND. SENSOPIA DISCLAIMS ANY WARRANTY INCLUDING, WITHOUT LIMITATION, SATISFACTORY QUALITY OR ACCURACY OF DIMENSIONS.

14 Africander Avenue

Bedroom

Width: 3.88 m
 Length: 4.44 m
 Area: 14.76 m²
 Perimeter: 15.36 m

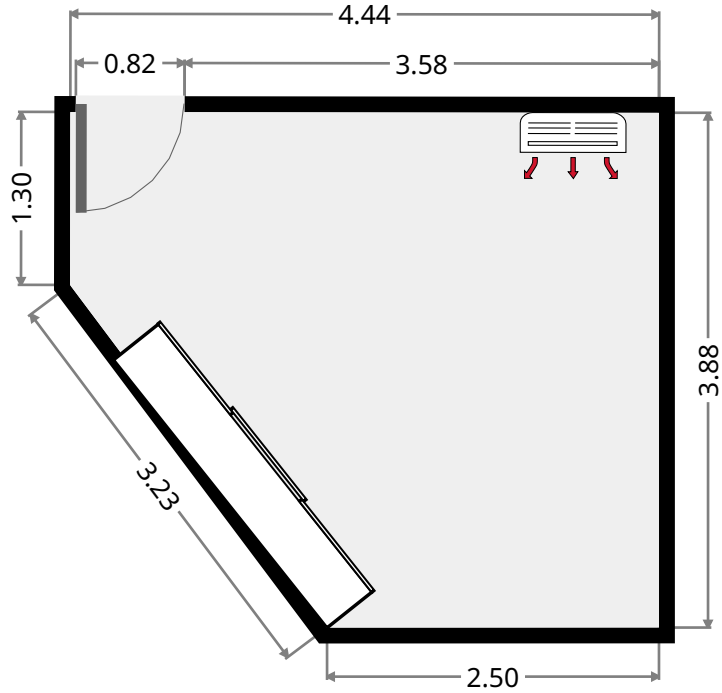
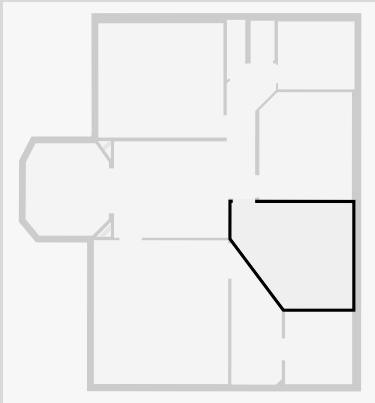

WIR

Width: 3.11 m
 Length: 5.20 m
 Area: 7.34 m²
 Perimeter: 12.76 m

