

13a Main Street

Ground Floor

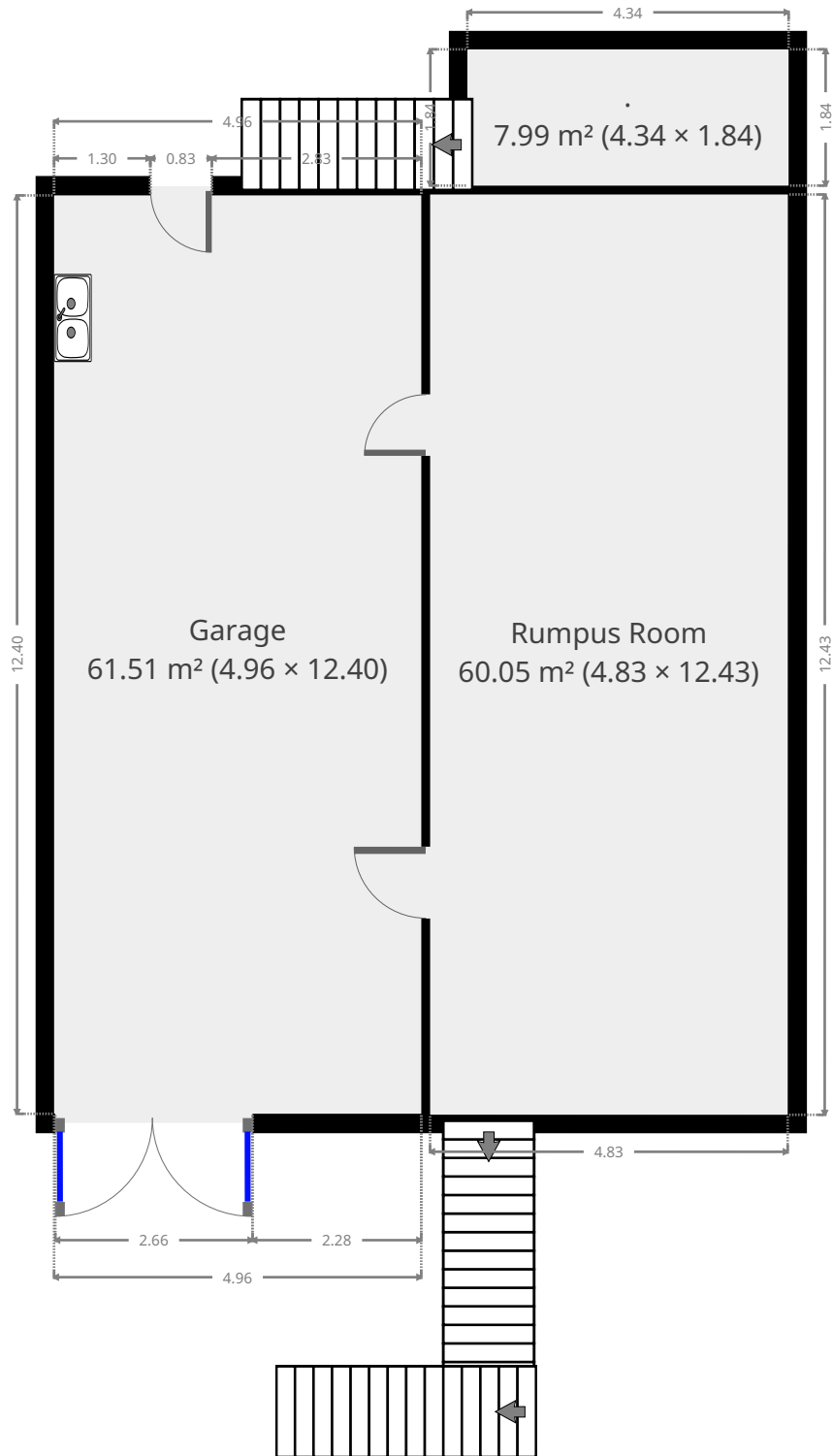

THIS FLOORPLAN IS PROVIDED WITHOUT WARRANTY OF ANY KIND. SENSOPIA DISCLAIMS ANY WARRANTY INCLUDING, WITHOUT LIMITATION, SATISFACTORY QUALITY OR ACCURACY OF DIMENSIONS.



13a Main Street

Rumpus Room

Width: 4.83 m
Length: 12.43 m
Area: 60.05 m²
Perimeter: 34.52 m

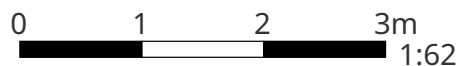
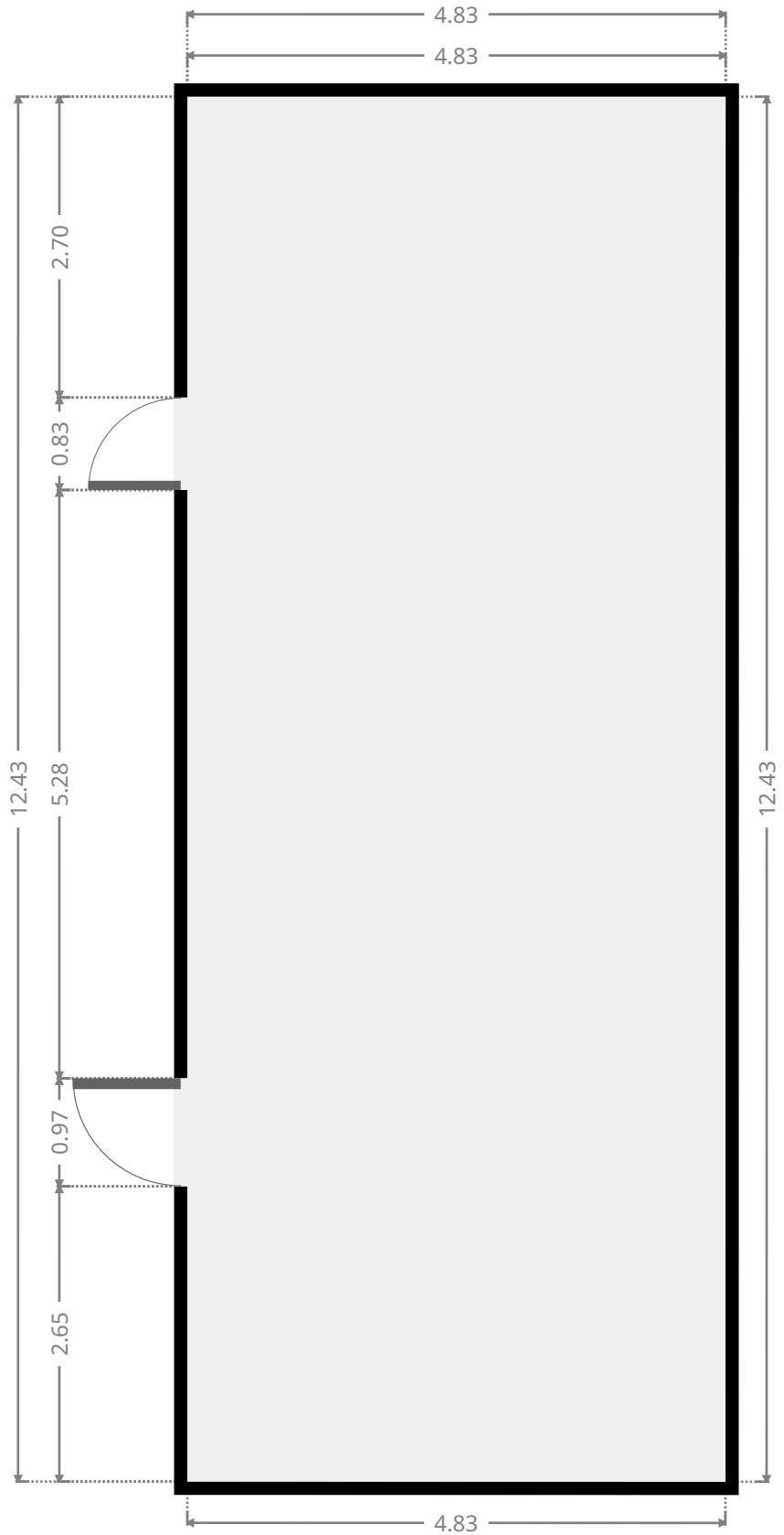
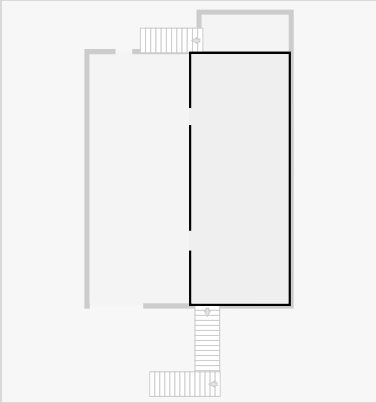

THIS FLOORPLAN IS PROVIDED WITHOUT WARRANTY OF ANY KIND. SENSOPIA DISCLAIMS ANY WARRANTY INCLUDING, WITHOUT LIMITATION, SATISFACTORY QUALITY OR ACCURACY OF DIMENSIONS.

13a Main Street

Garage

Width: 4.96 m
Length: 12.40 m
Area: 61.51 m²
Perimeter: 34.72 m

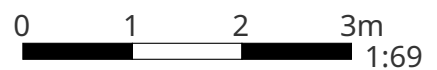
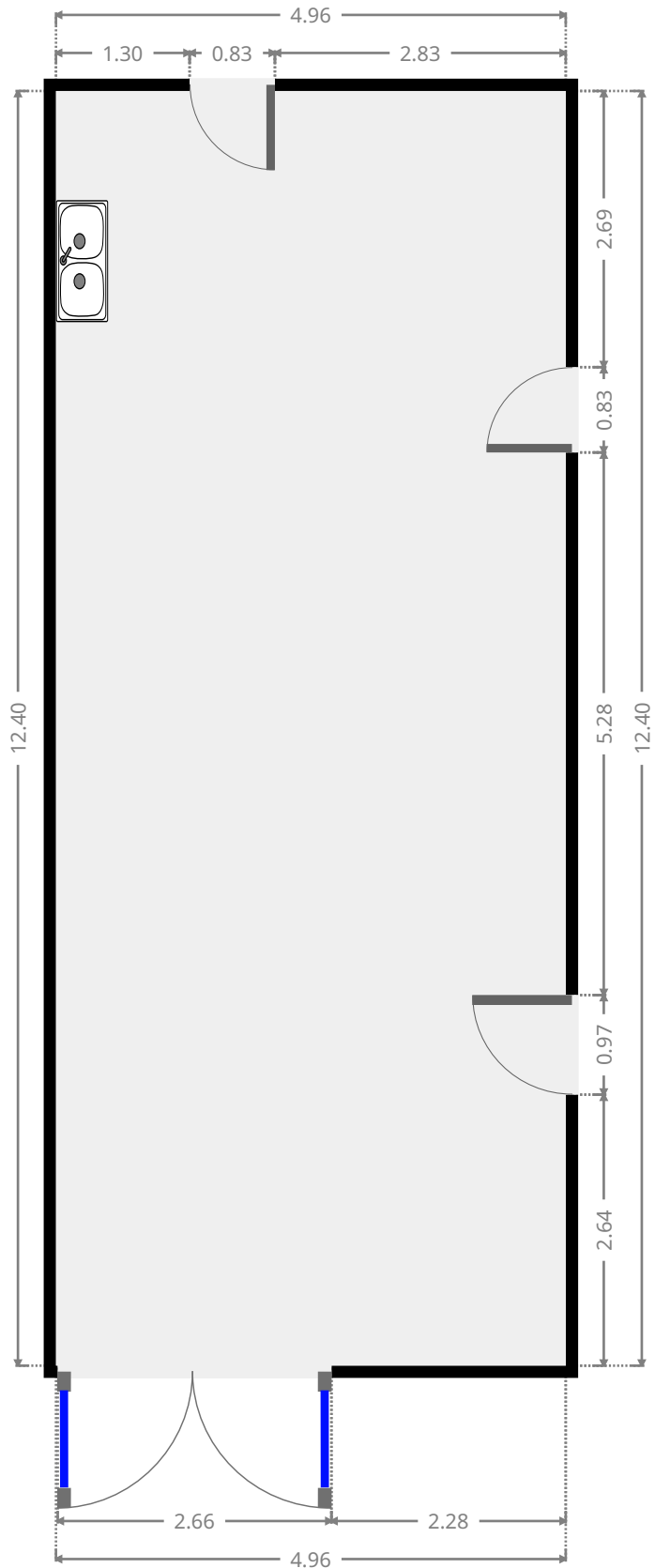
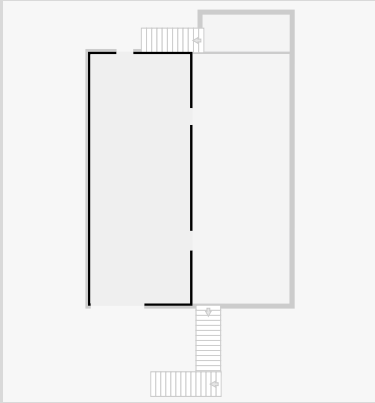

THIS FLOORPLAN IS PROVIDED WITHOUT WARRANTY OF ANY KIND. SENSOPIA DISCLAIMS ANY WARRANTY INCLUDING, WITHOUT LIMITATION, SATISFACTORY QUALITY OR ACCURACY OF DIMENSIONS.

13a Main Street

•
Width: 1.84 m
Length: 4.34 m
Area: 7.99 m²
Perimeter: 12.36 m

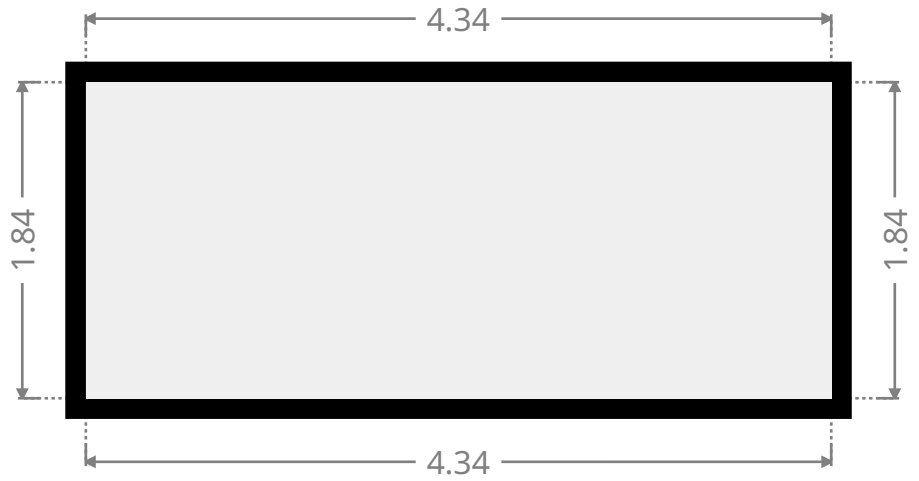
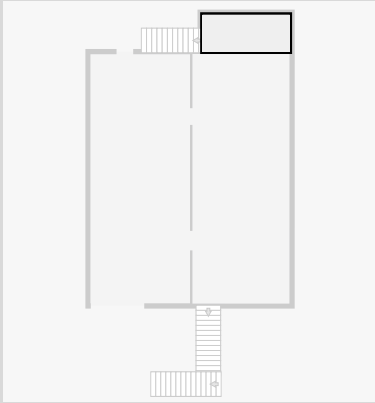

13a Main Street

1st Floor

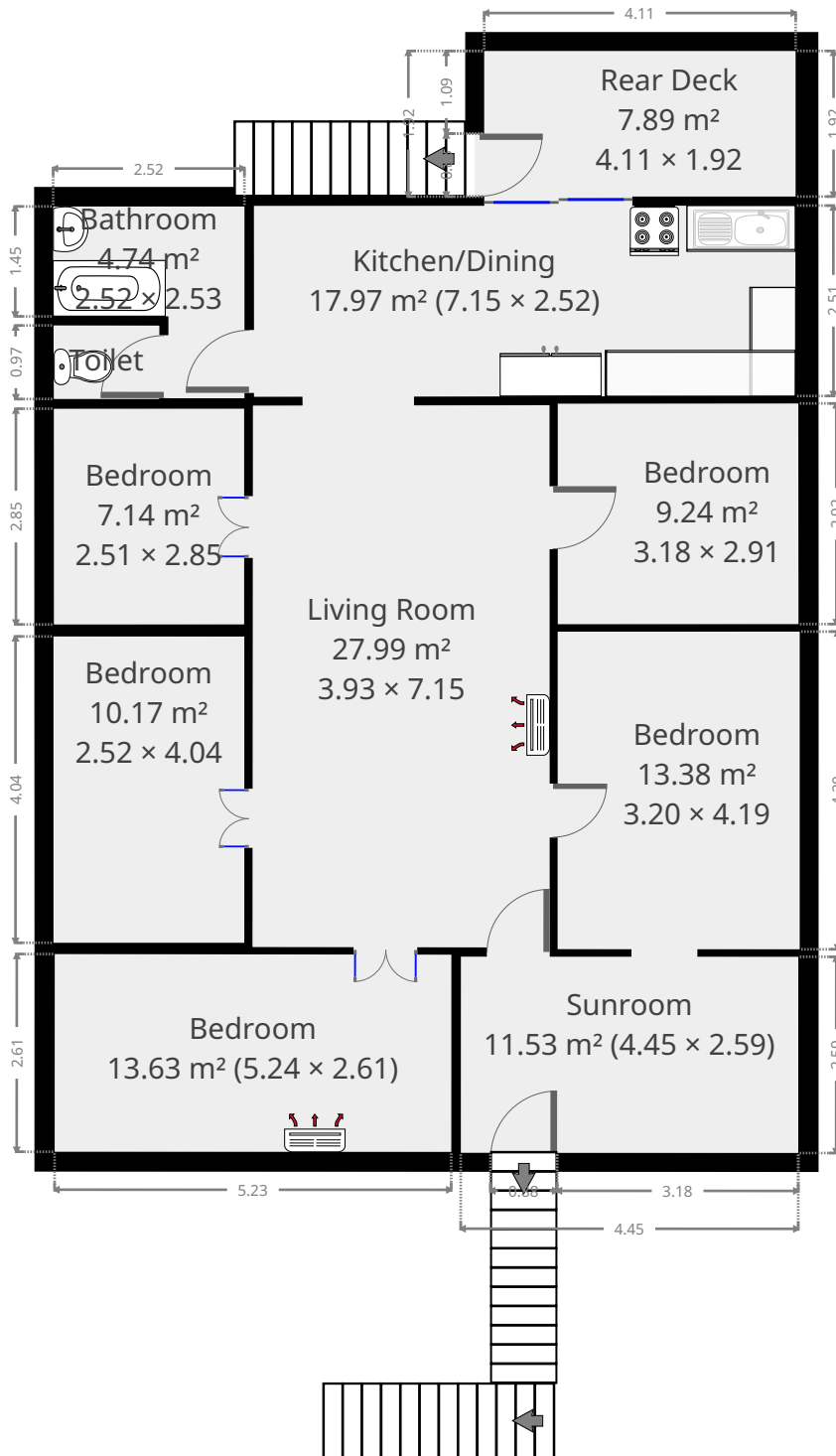

THIS FLOORPLAN IS PROVIDED WITHOUT WARRANTY OF ANY KIND. SENSOPIA DISCLAIMS ANY WARRANTY INCLUDING, WITHOUT LIMITATION, SATISFACTORY QUALITY OR ACCURACY OF DIMENSIONS.

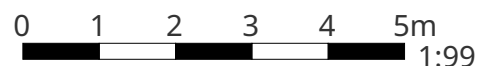

13a Main Street

Sunroom

Width: 2.59 m
 Length: 4.45 m
 Area: 11.53 m²
 Perimeter: 14.08 m

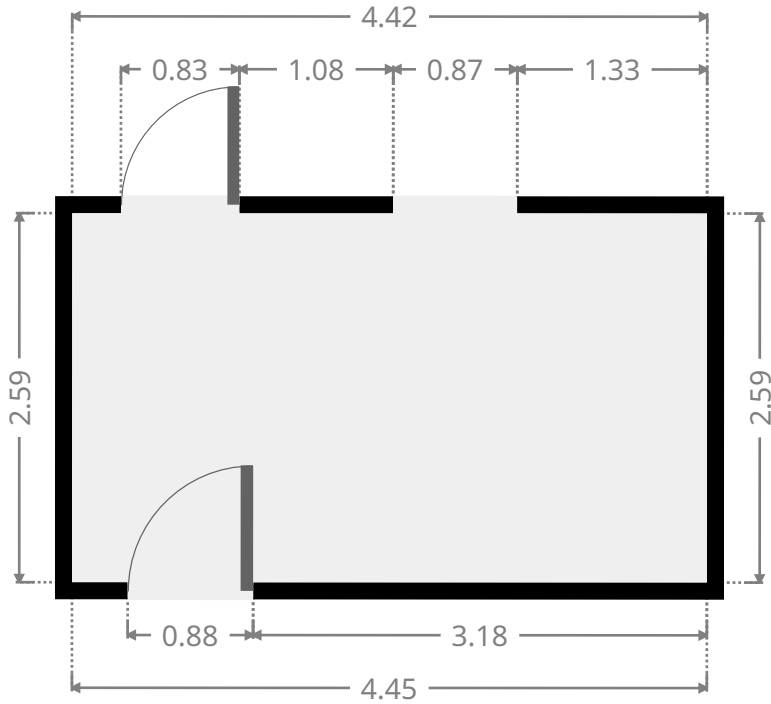
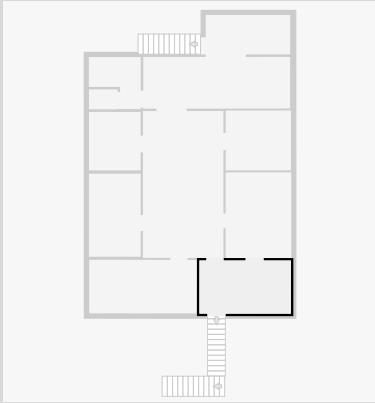

Bedroom

Width: 3.20 m
 Length: 4.19 m
 Area: 13.38 m²
 Perimeter: 14.77 m

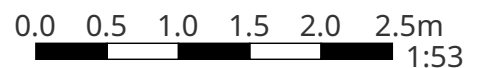
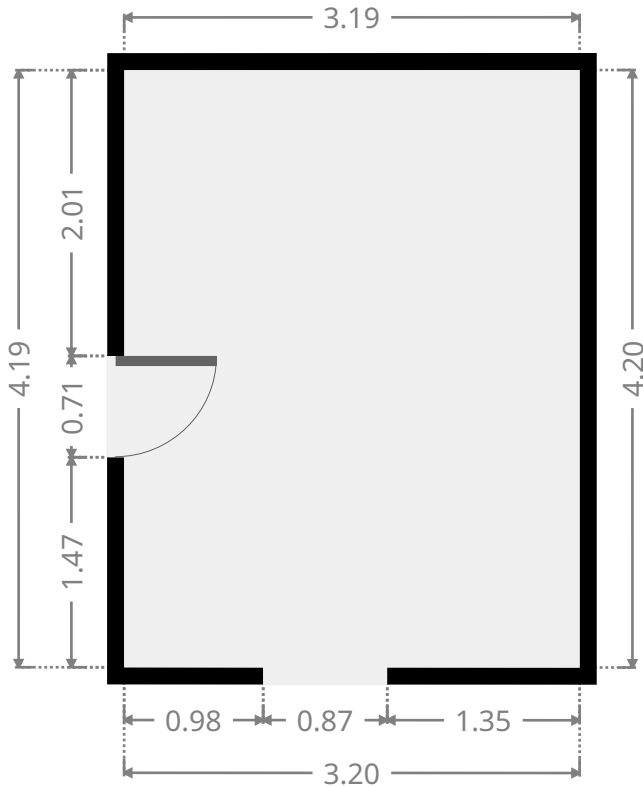
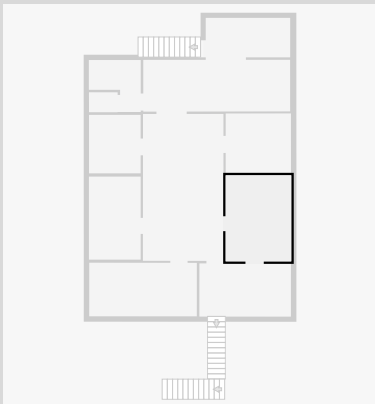

THIS FLOORPLAN IS PROVIDED WITHOUT WARRANTY OF ANY KIND. SENSOPIA DISCLAIMS ANY WARRANTY INCLUDING, WITHOUT LIMITATION, SATISFACTORY QUALITY OR ACCURACY OF DIMENSIONS.

13a Main Street

Living Room

Width: 3.93 m
 Length: 7.15 m
 Area: 27.99 m²
 Perimeter: 22.13 m

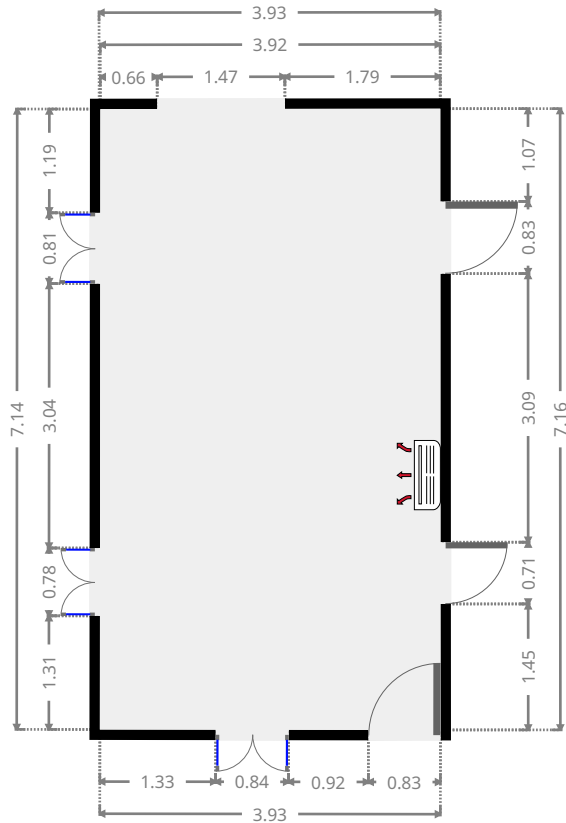
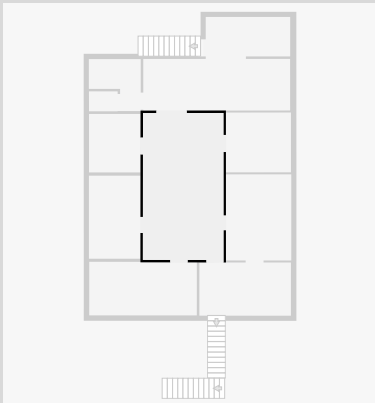

Bedroom

Width: 2.61 m
 Length: 5.24 m
 Area: 13.63 m²
 Perimeter: 15.68 m

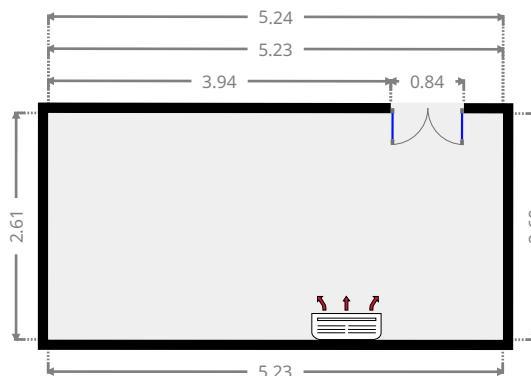
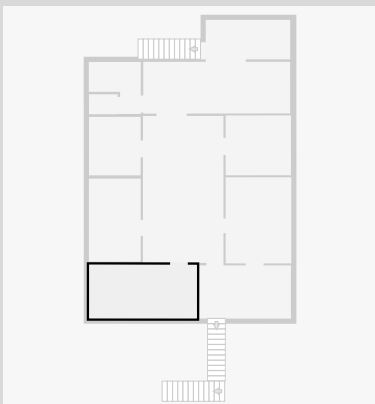

13a Main Street

Bedroom

Width: 2.52 m
Length: 4.04 m
Area: 10.17 m²
Perimeter: 13.12 m

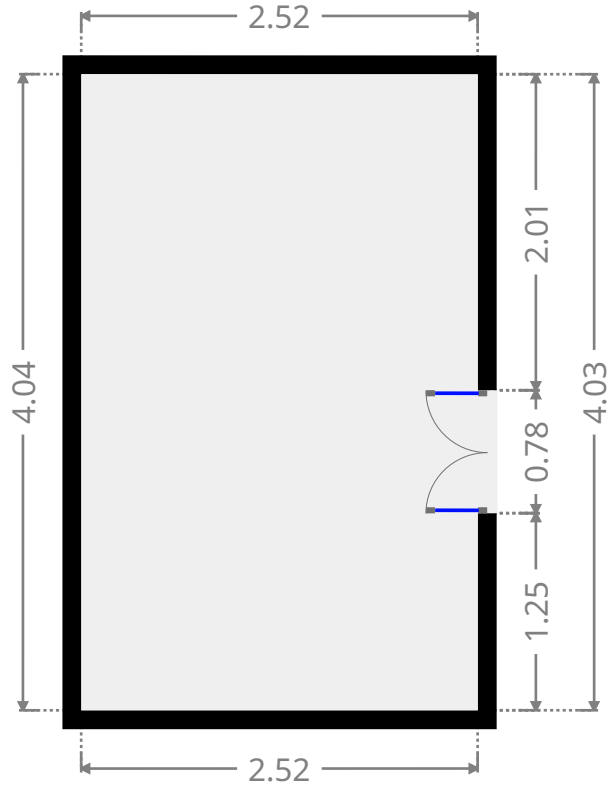
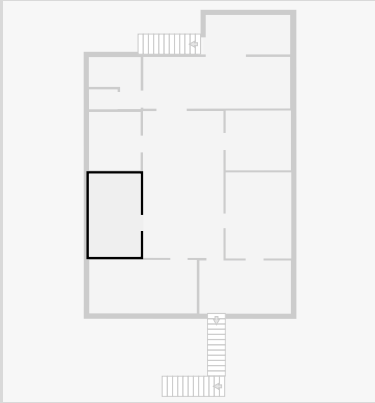

Bedroom

Width: 2.51 m
Length: 2.85 m
Area: 7.14 m²
Perimeter: 10.71 m

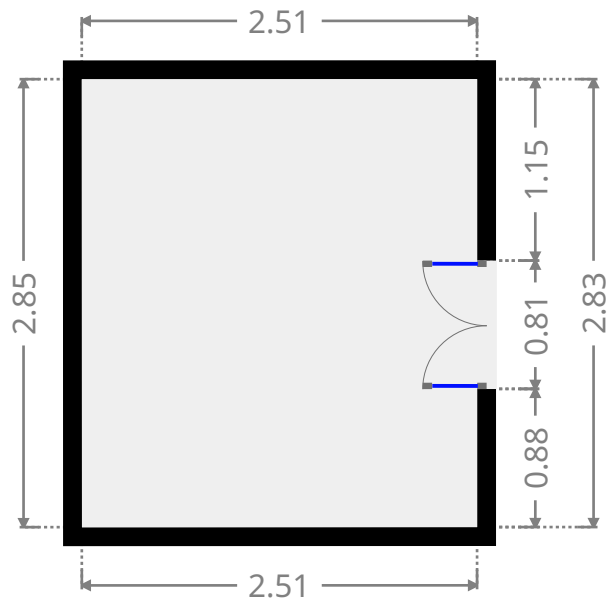
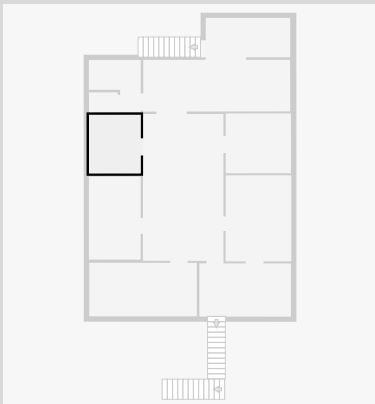

13a Main Street

Bedroom

Width: 2.91 m
 Length: 3.18 m
 Area: 9.24 m²
 Perimeter: 12.17 m

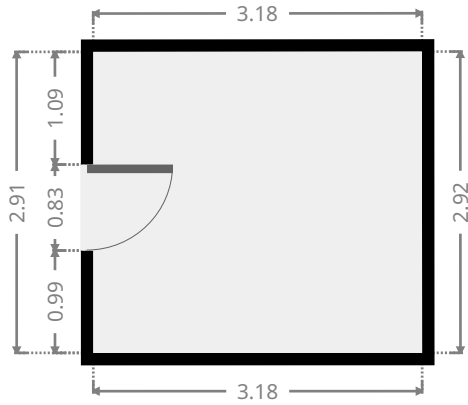
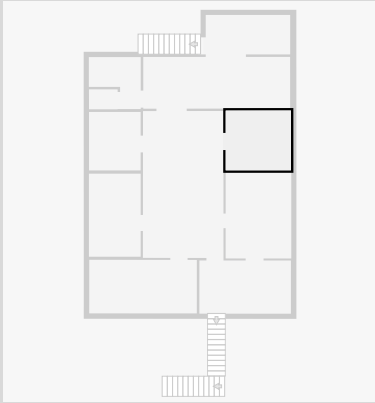

Kitchen/Dining

Width: 2.52 m
 Length: 7.15 m
 Area: 17.97 m²
 Perimeter: 19.32 m

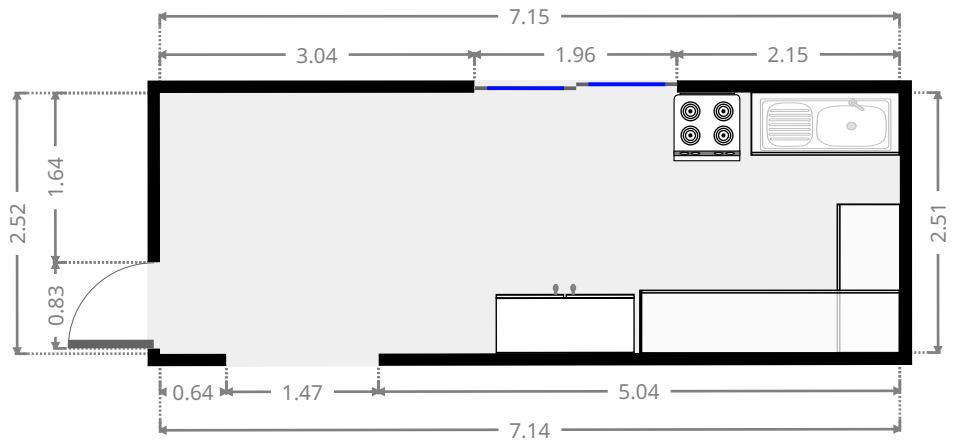
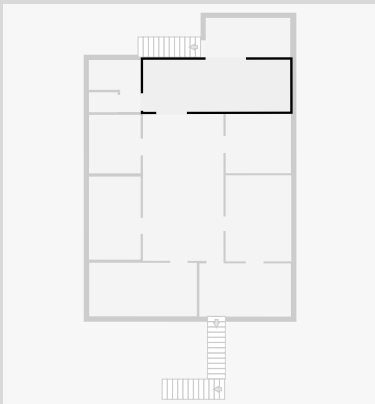

13a Main Street

Rear Deck

Width: 1.92 m
 Length: 4.11 m
 Area: 7.89 m²
 Perimeter: 12.06 m

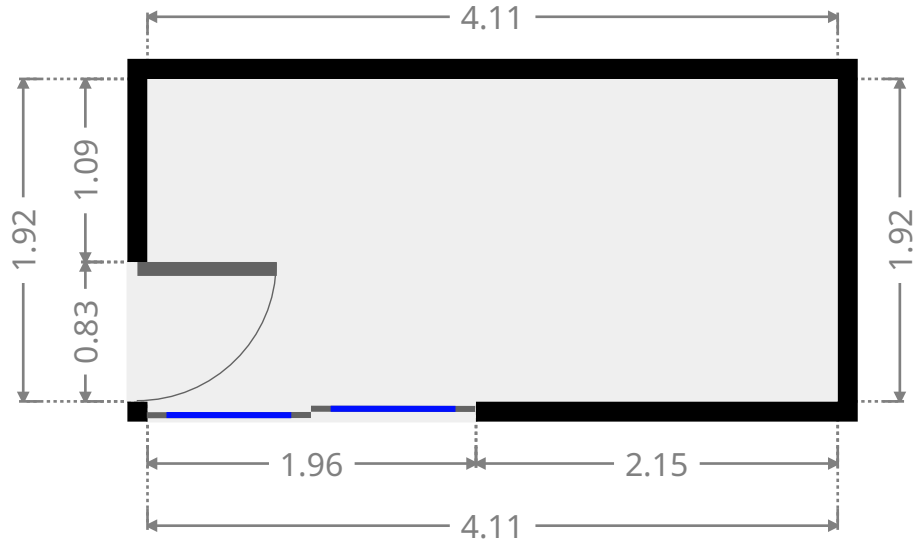
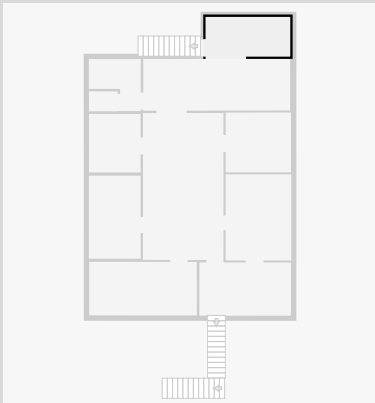

Bathroom

Width: 2.52 m
 Length: 2.53 m
 Area: 4.74 m²
 Perimeter: 10.11 m

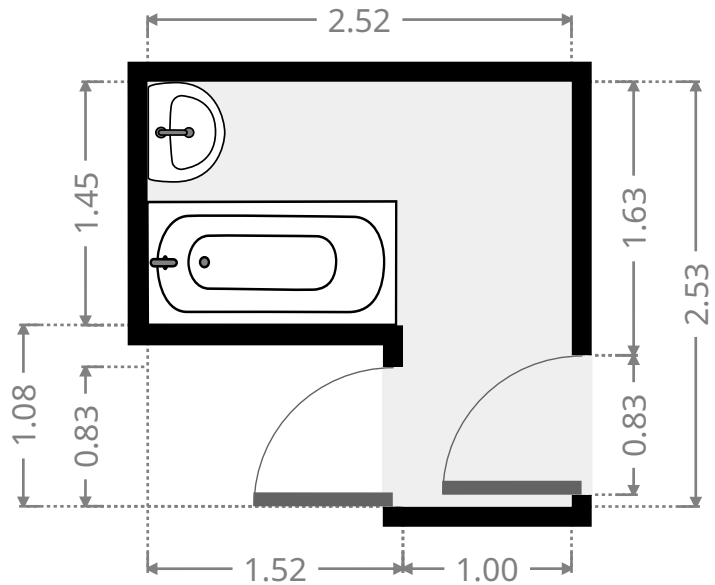
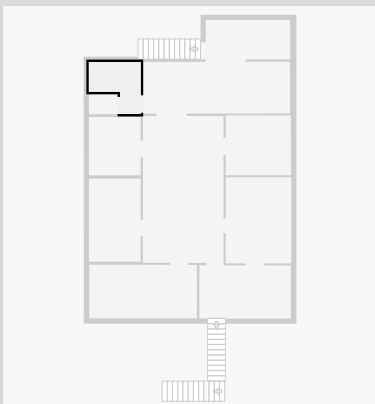

THIS FLOORPLAN IS PROVIDED WITHOUT WARRANTY OF ANY KIND. SENSOPIA DISCLAIMS ANY WARRANTY INCLUDING, WITHOUT LIMITATION, SATISFACTORY QUALITY OR ACCURACY OF DIMENSIONS.

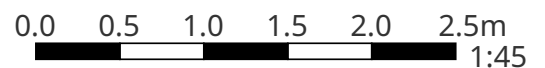

13a Main Street

Toilet / Half Bath

Width: 0.97 m
Length: 1.40 m
Area: 1.35 m²
Perimeter: 4.72 m

