

# 139 Haynes Street

**SUBMITTED BY**

Ray White Rockhampton Casey  
stockers@cqoz.com

---

**CREATED ON**

2021-12-08

---

**Floors**

2

---

▼ Ground Floor

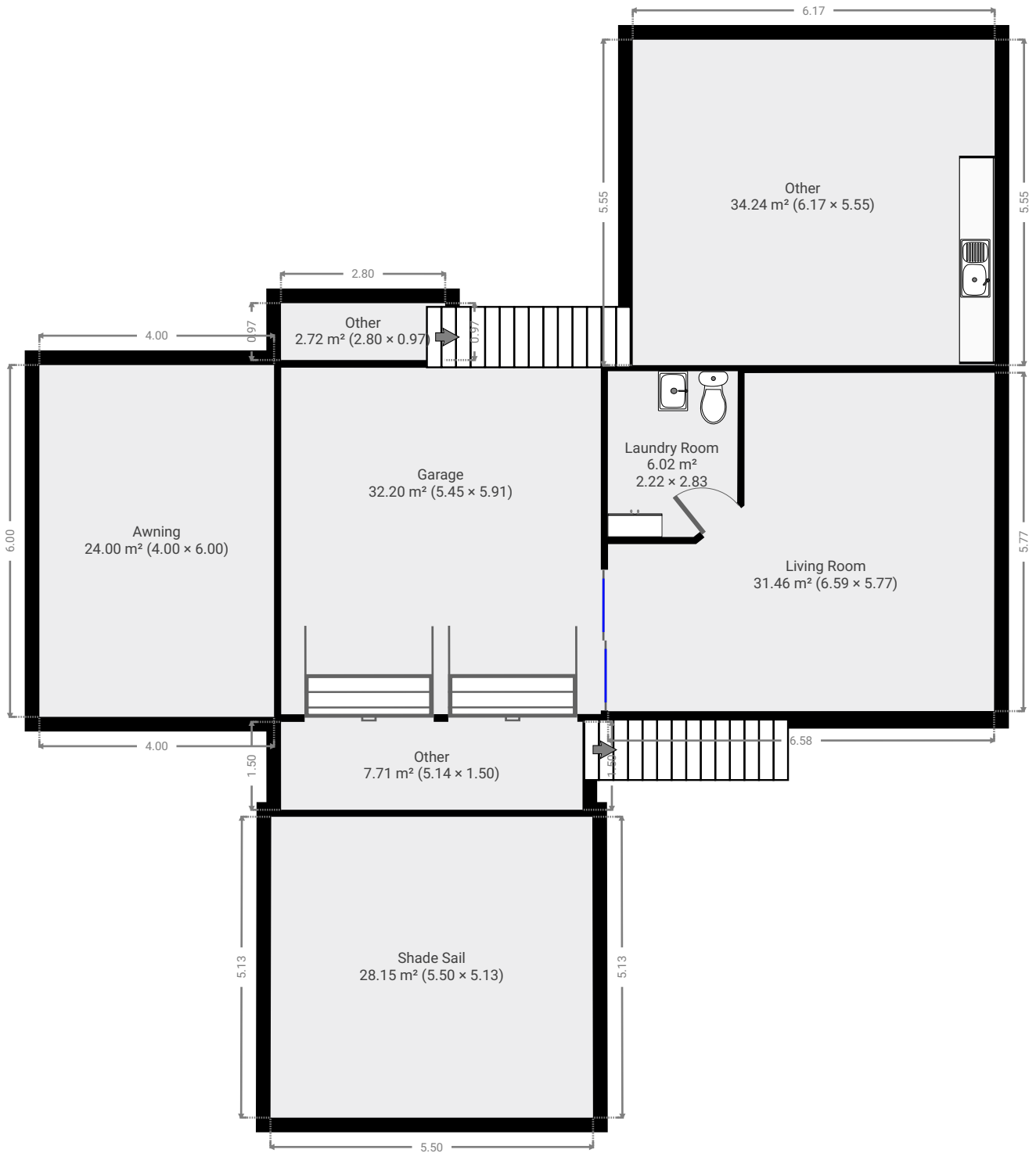

▼ **Garage**  
Ground Floor

WIDTH: 5.45 m • LENGTH: 5.91 m  
AREA: 32.20 m<sup>2</sup> • PERIMETER: 22.72 m

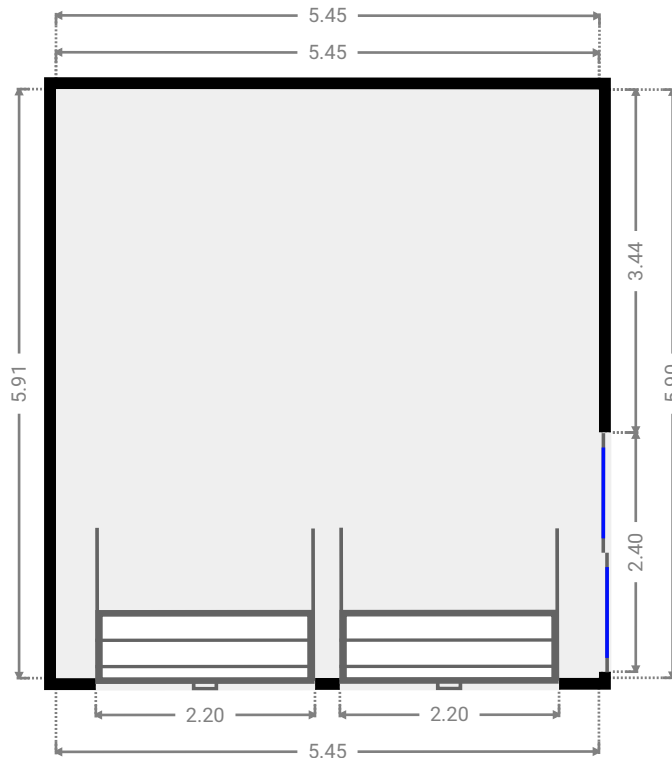
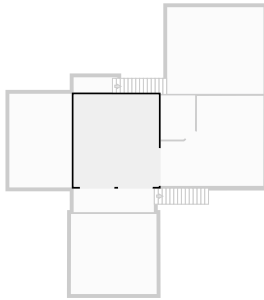

▼ **Living Room**  
Ground Floor

WIDTH: 6.59 m • LENGTH: 5.77 m  
AREA: 31.46 m<sup>2</sup> • PERIMETER: 24.28 m

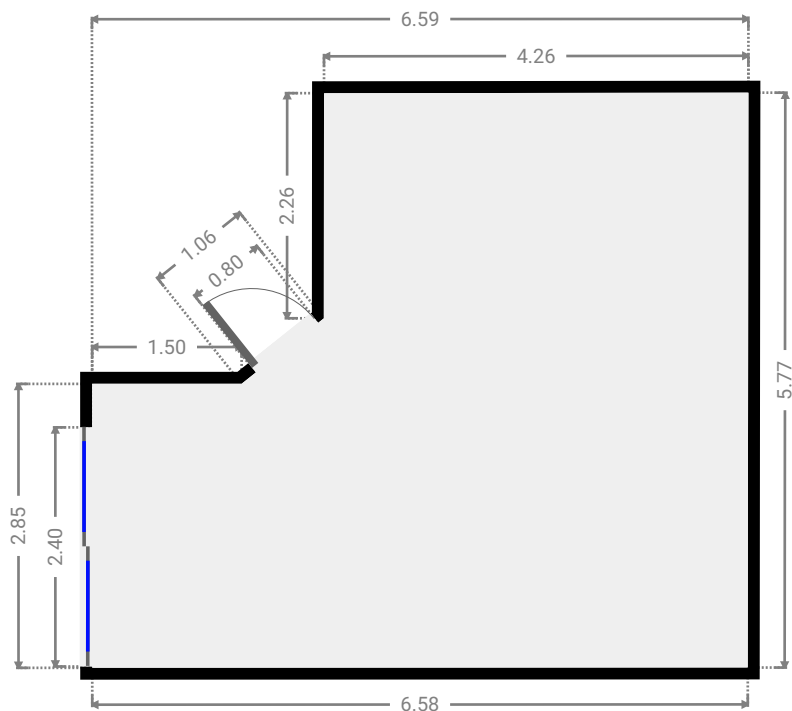
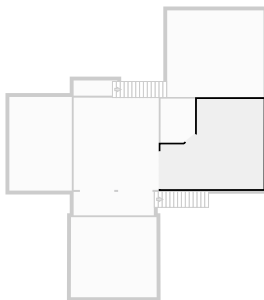

▼ **Laundry Room**  
Ground Floor

WIDTH: 2.22 m • LENGTH: 2.83 m  
AREA: 6.02 m<sup>2</sup> • PERIMETER: 9.69 m

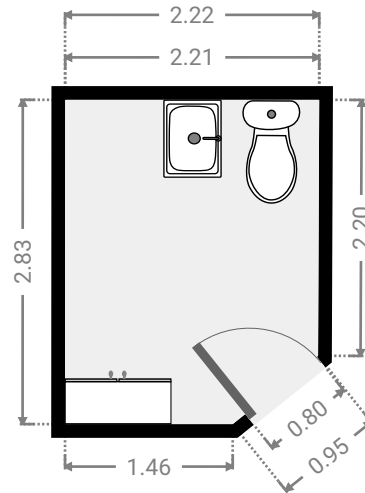
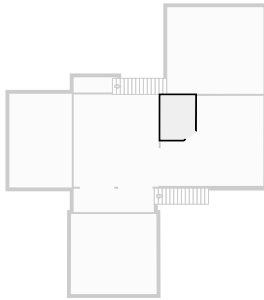

▼ **Other**  
Ground Floor

WIDTH: 6.17 m • LENGTH: 5.55 m  
AREA: 34.24 m<sup>2</sup> • PERIMETER: 23.44 m

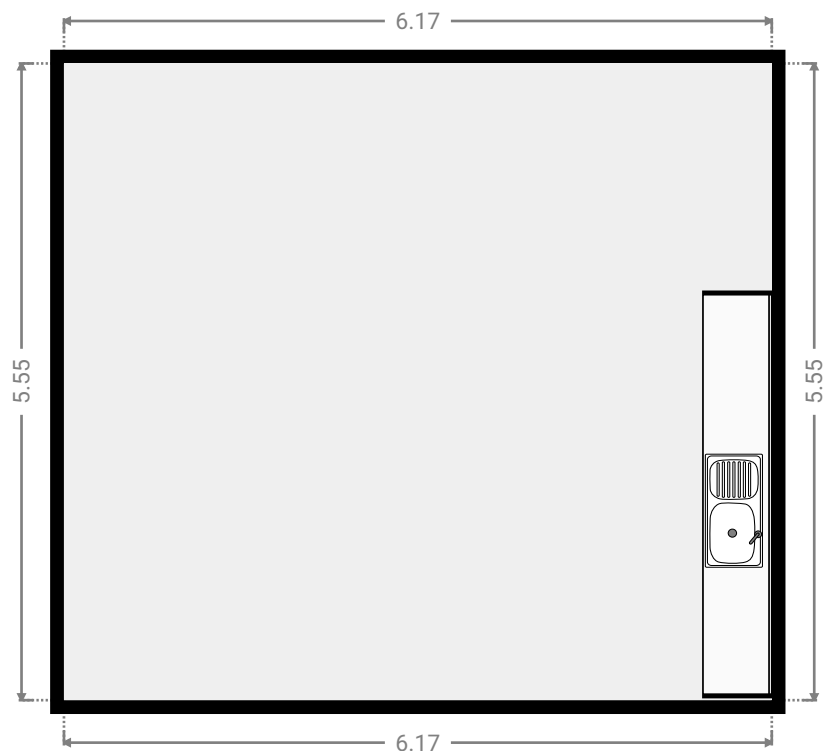
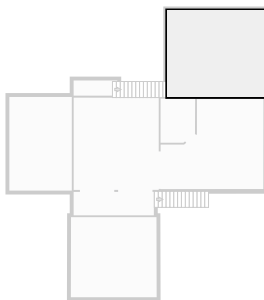

▼ Other  
Ground Floor

WIDTH: 2.80 m • LENGTH: 0.97 m  
AREA: 2.72 m<sup>2</sup> • PERIMETER: 7.54 m

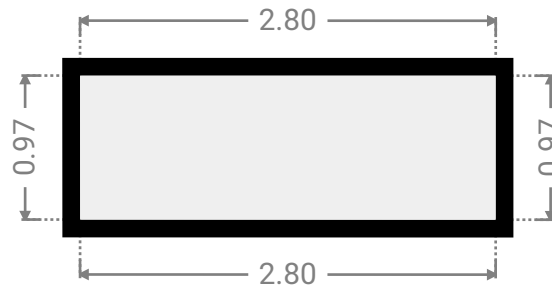
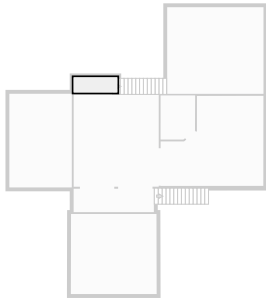

▼ Other  
Ground Floor

WIDTH: 5.14 m • LENGTH: 1.50 m  
AREA: 7.71 m<sup>2</sup> • PERIMETER: 13.28 m

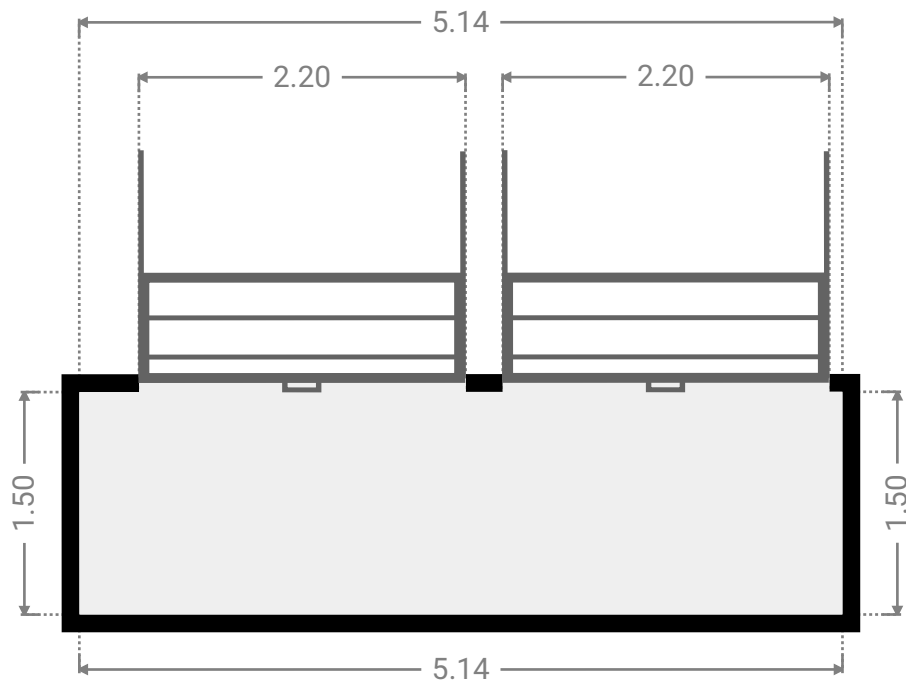
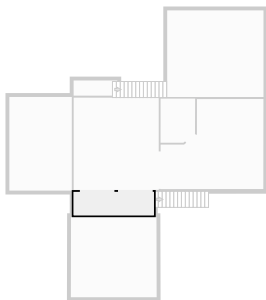

▼ **Shade Sail**  
Ground Floor

WIDTH: 5.50 m • LENGTH: 5.13 m  
AREA: 28.15 m<sup>2</sup> • PERIMETER: 21.23 m

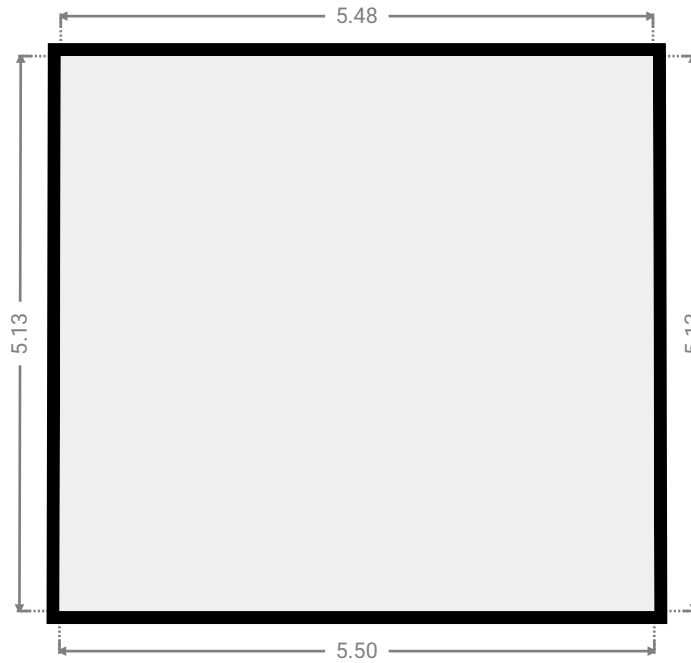
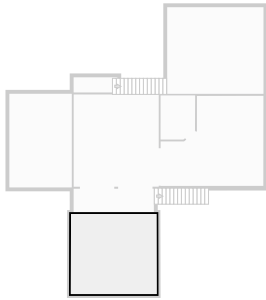

▼ **Awning**  
Ground Floor

WIDTH: 4.00 m • LENGTH: 6.00 m  
AREA: 24.00 m<sup>2</sup> • PERIMETER: 20.00 m

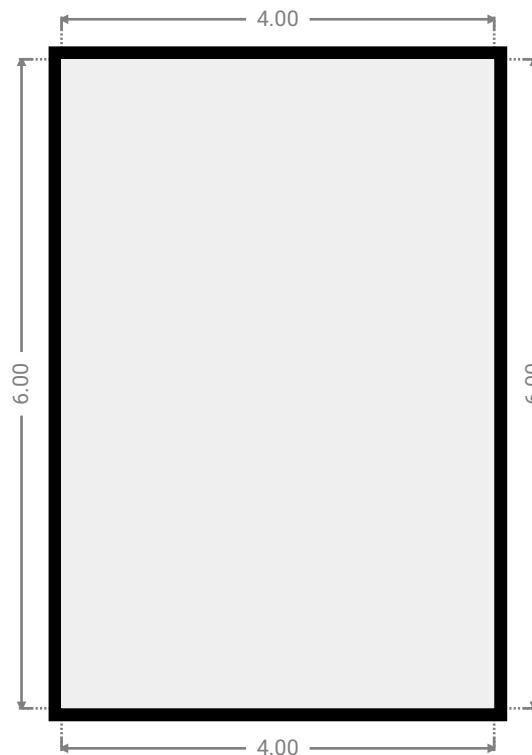
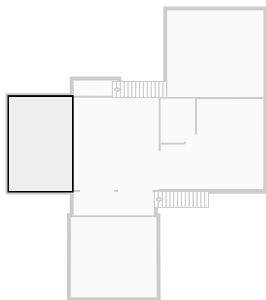

▼ 1st Floor

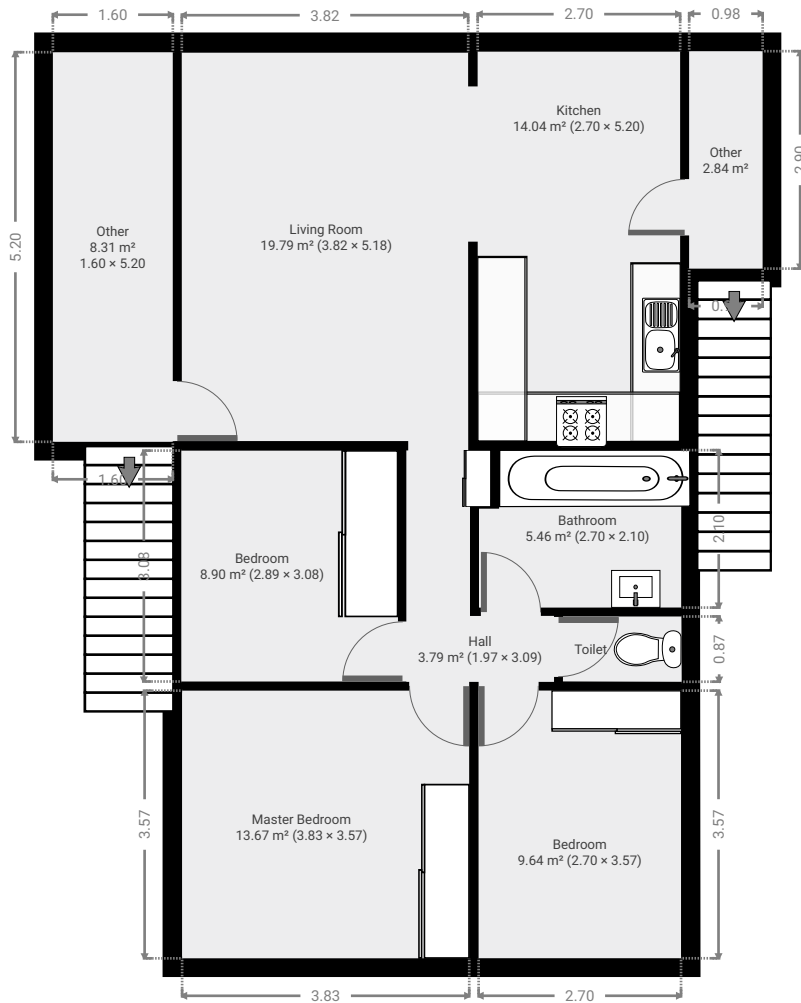

▼ Living Room  
1st Floor

WIDTH: 5.18 m • LENGTH: 3.82 m  
AREA: 19.79 m<sup>2</sup> • PERIMETER: 18.00 m

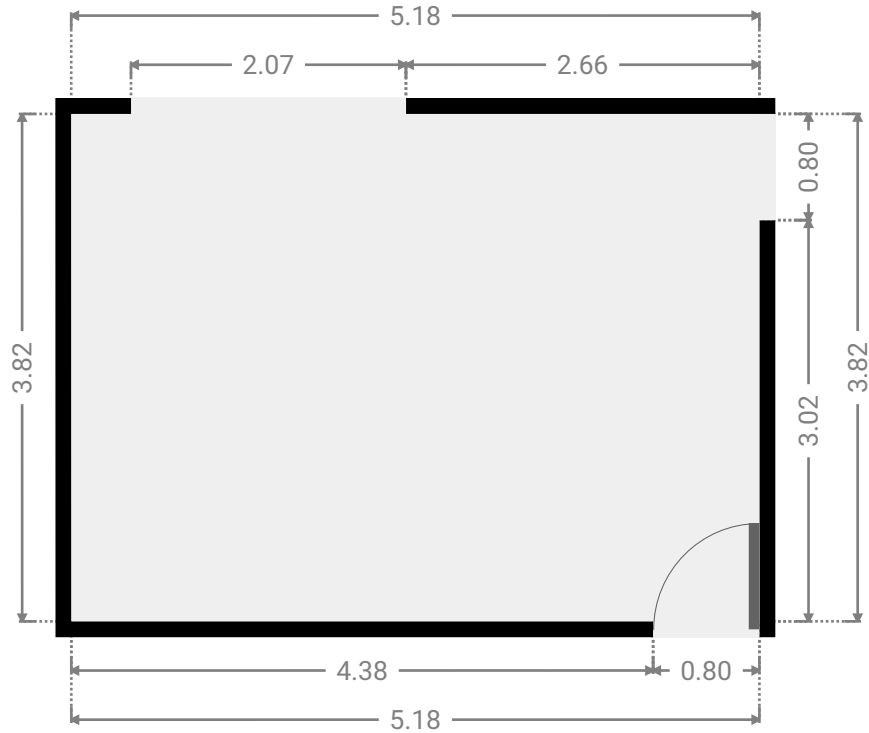
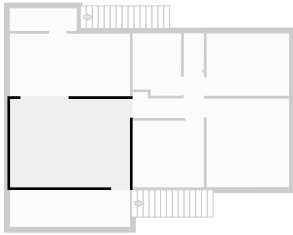

▼ Kitchen  
1st Floor

WIDTH: 5.20 m • LENGTH: 2.70 m  
AREA: 14.04 m<sup>2</sup> • PERIMETER: 15.80 m

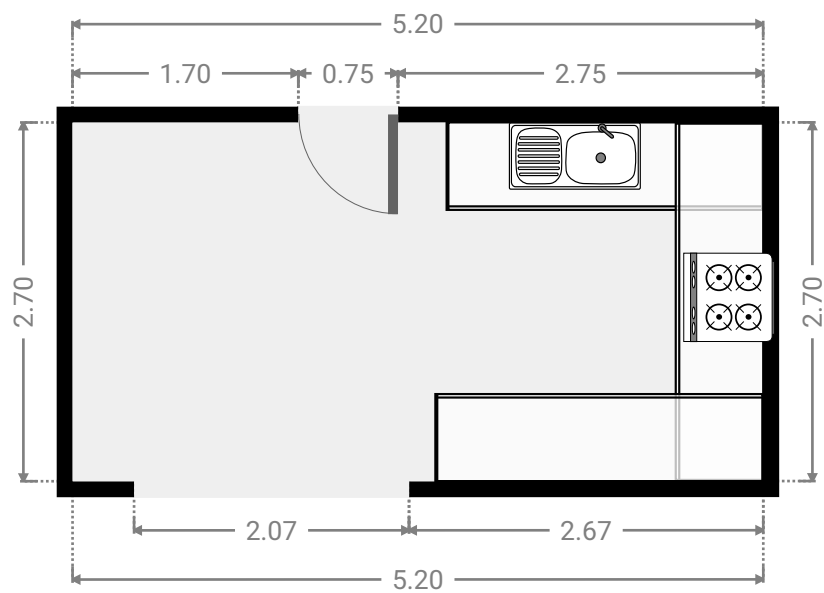



▼ **Other**  
1st Floor

WIDTH: 2.90 m • LENGTH: 0.98 m  
AREA: 2.84 m<sup>2</sup> • PERIMETER: 7.76 m

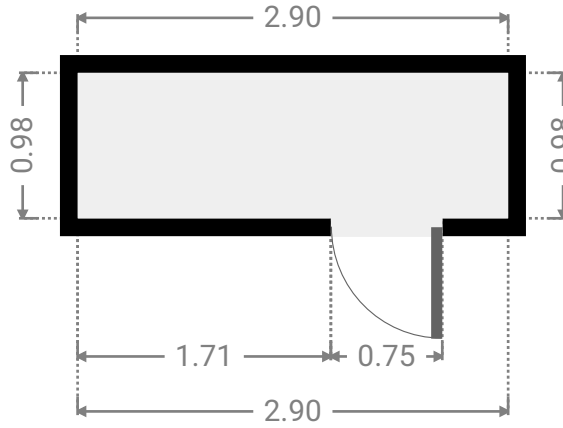
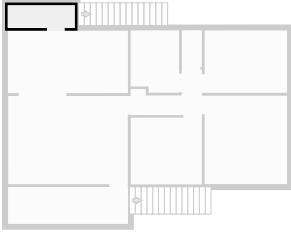

▼ **Hall**  
1st Floor

WIDTH: 3.09 m • LENGTH: 1.97 m  
AREA: 3.79 m<sup>2</sup> • PERIMETER: 10.67 m

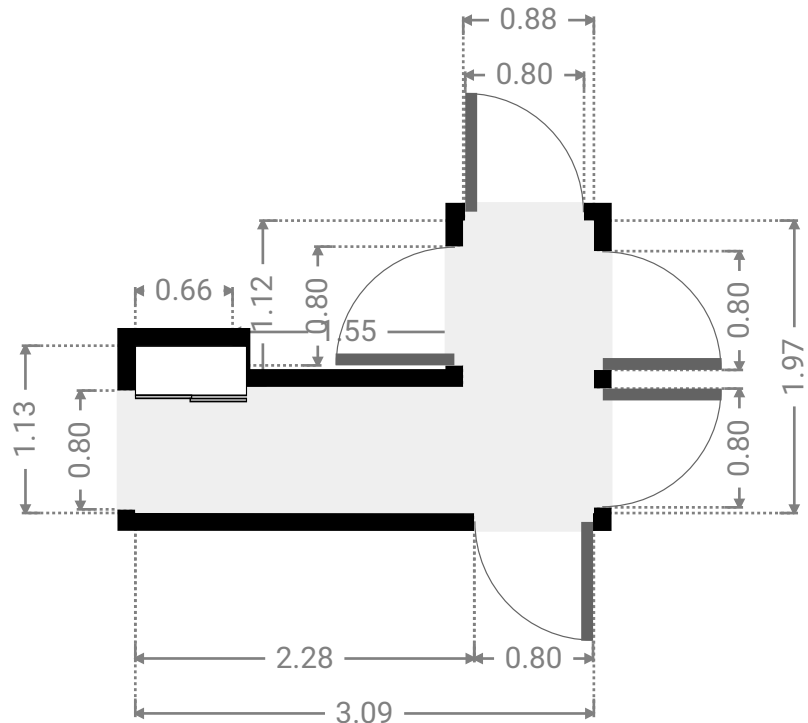
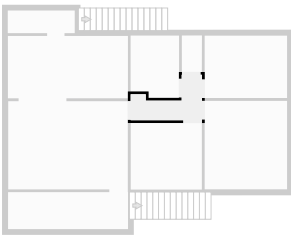

▼ **Bedroom**  
1st Floor

WIDTH: 3.08 m • LENGTH: 2.89 m  
AREA: 8.90 m<sup>2</sup> • PERIMETER: 11.94 m

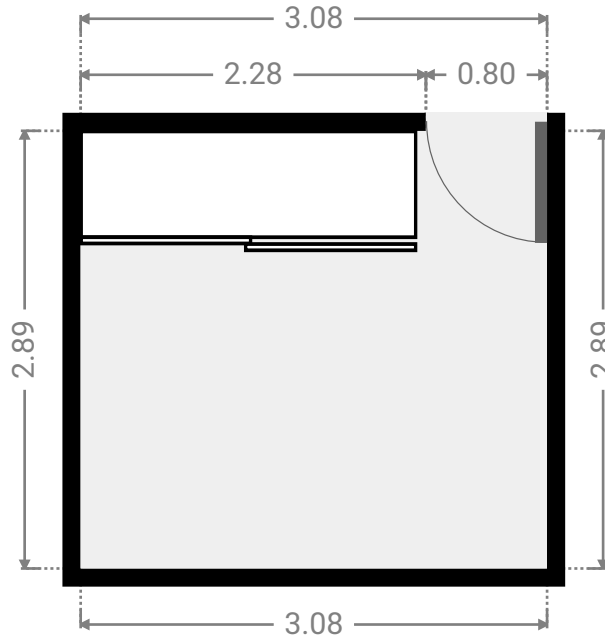
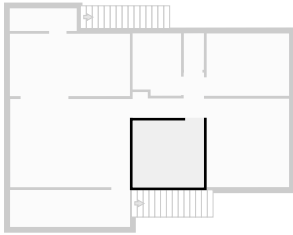

▼ **Master Bedroom**  
1st Floor

WIDTH: 3.57 m • LENGTH: 3.83 m  
AREA: 13.67 m<sup>2</sup> • PERIMETER: 14.80 m

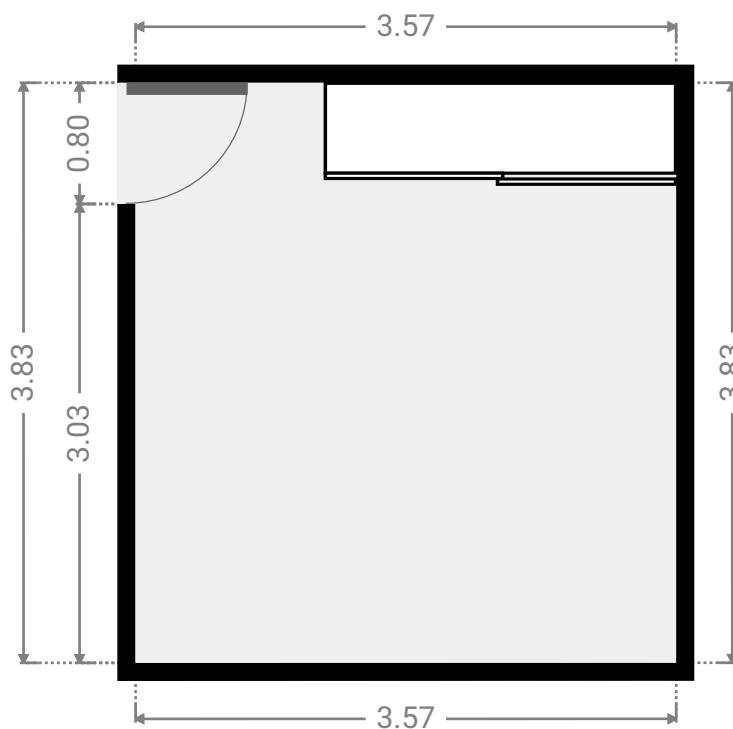
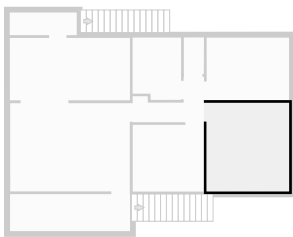

▼ **Bedroom**  
1st Floor

WIDTH: 3.57 m • LENGTH: 2.70 m  
AREA: 9.64 m<sup>2</sup> • PERIMETER: 12.54 m

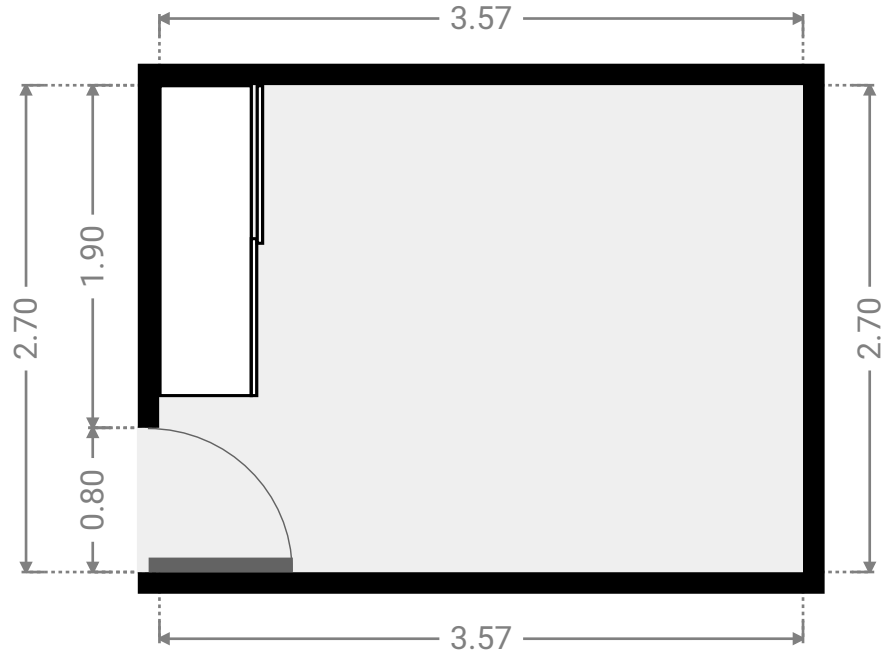
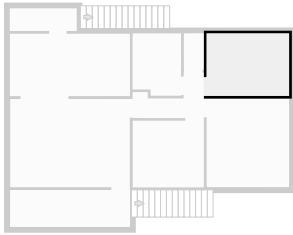

▼ **Bathroom**  
1st Floor

WIDTH: 2.10 m • LENGTH: 2.70 m  
AREA: 5.46 m<sup>2</sup> • PERIMETER: 9.60 m

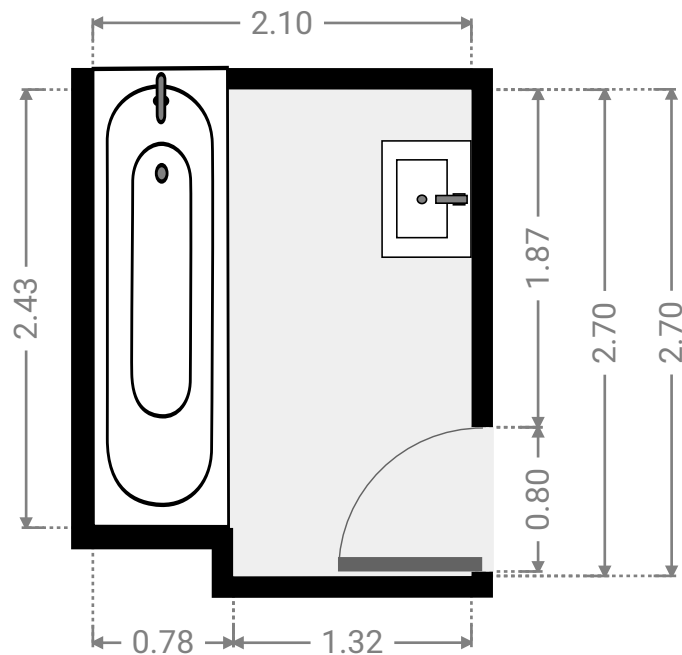
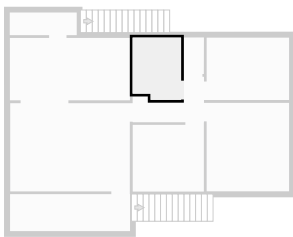

▼ Toilet  
1st Floor

WIDTH: 0.87 m • LENGTH: 1.58 m  
AREA: 1.37 m<sup>2</sup> • PERIMETER: 4.90 m

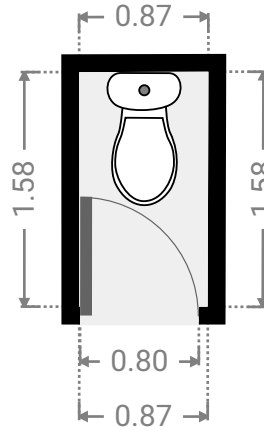
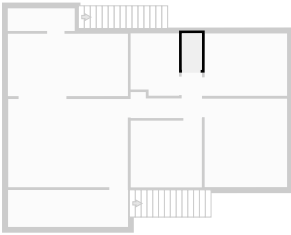

▼ Other  
1st Floor

WIDTH: 5.20 m • LENGTH: 1.60 m  
AREA: 8.31 m<sup>2</sup> • PERIMETER: 13.59 m

