

# 138 Gair Street

## Ground Floor

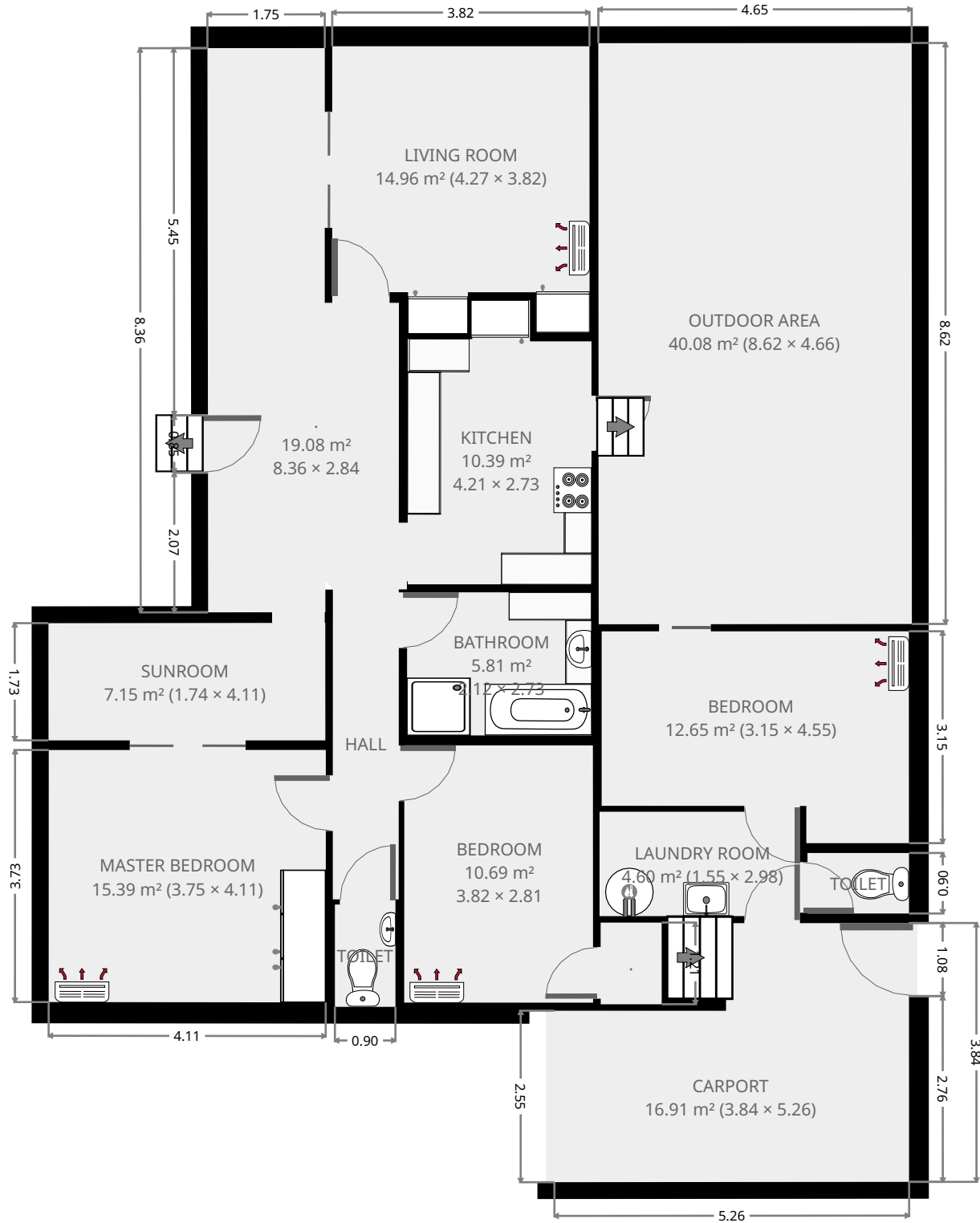

THIS FLOORPLAN IS PROVIDED WITHOUT WARRANTY OF ANY KIND. SENSOPIA DISCLAIMS ANY WARRANTY INCLUDING, WITHOUT LIMITATION, SATISFACTORY QUALITY OR ACCURACY OF DIMENSIONS.



# 138 Gair Street

•  
 Width: 2.84 m  
 Length: 8.36 m  
 Area: 19.08 m<sup>2</sup>  
 Perimeter: 22.42 m

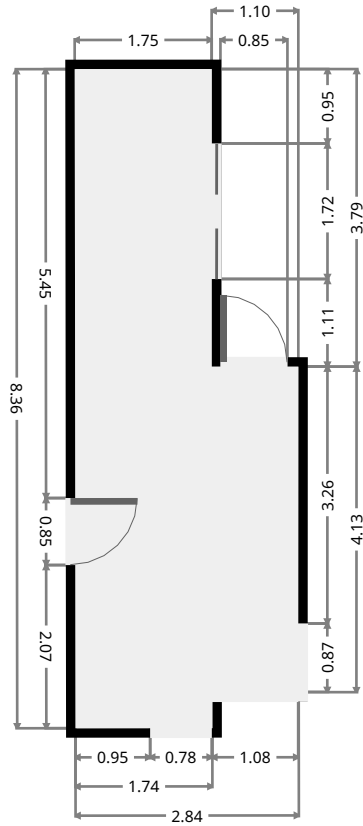
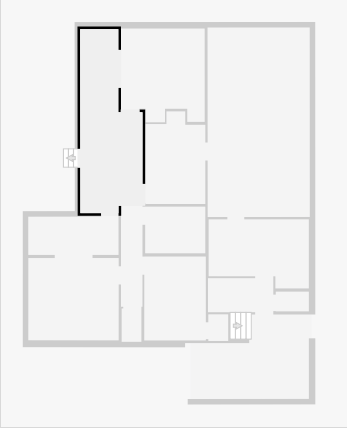

## Living Room

Width: 3.82 m  
 Length: 4.27 m  
 Area: 14.96 m<sup>2</sup>  
 Perimeter: 17.36 m

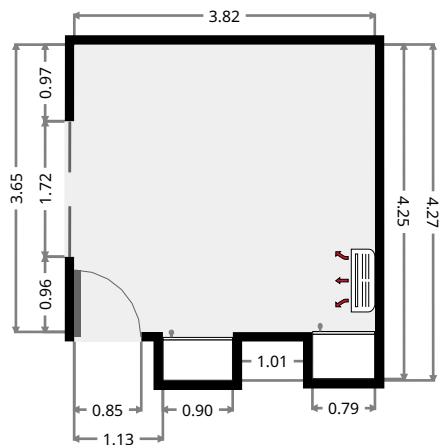
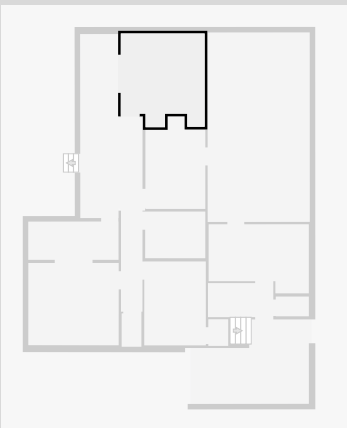

# 138 Gair Street

## Hall

Width: 0.98 m  
 Length: 4.61 m  
 Area: 4.50 m<sup>2</sup>  
 Perimeter: 11.17 m

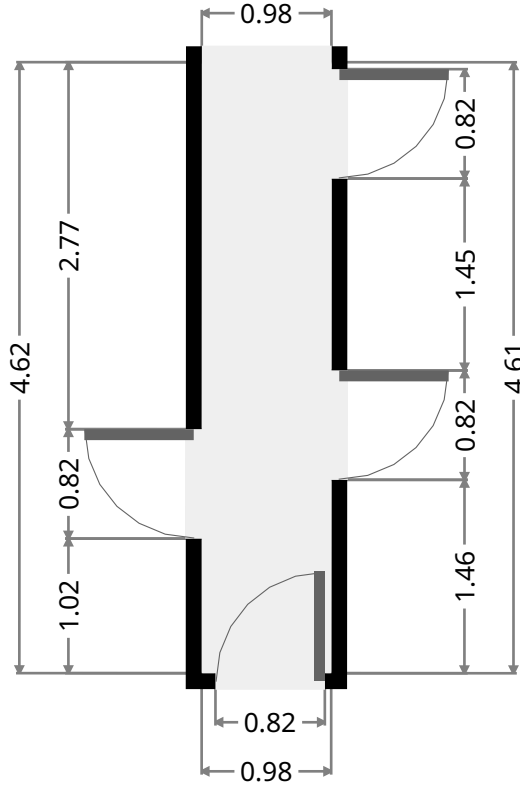
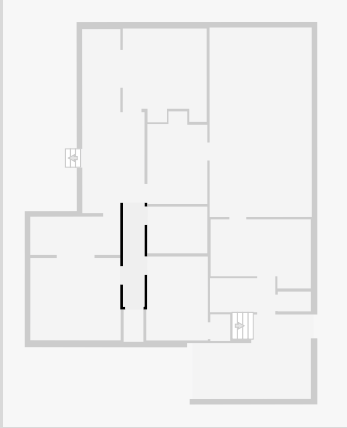

## Kitchen

Width: 2.73 m  
 Length: 4.21 m  
 Area: 10.39 m<sup>2</sup>  
 Perimeter: 13.88 m

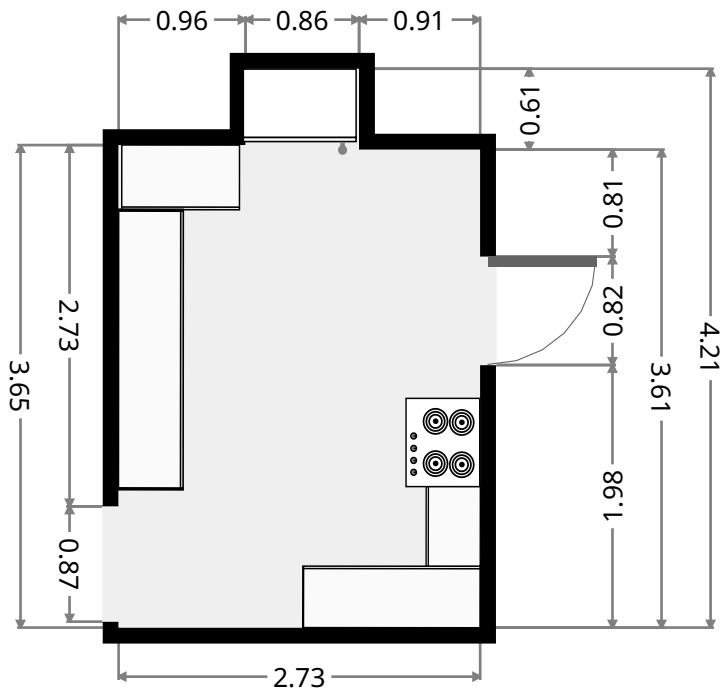
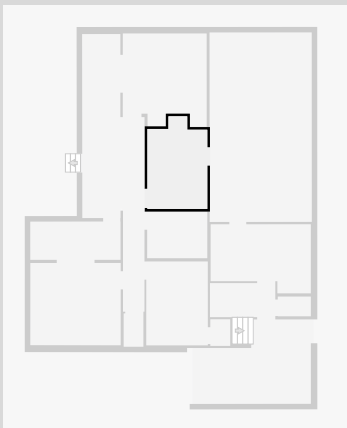

# 138 Gair Street

## Sunroom

Width: 1.74 m  
 Length: 4.11 m  
 Area: 7.15 m<sup>2</sup>  
 Perimeter: 11.70 m

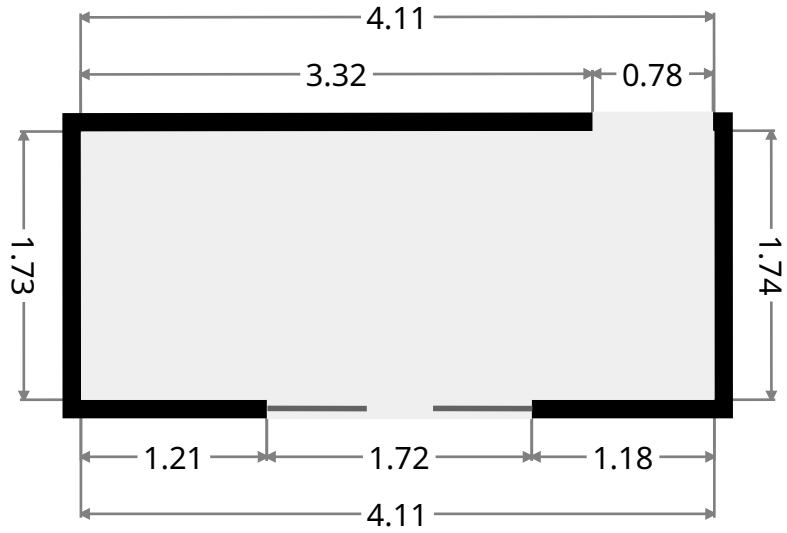
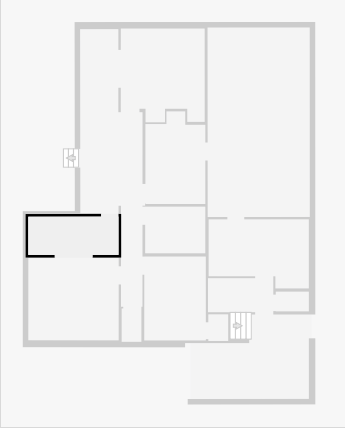

## Master Bedroom

Width: 3.75 m  
 Length: 4.11 m  
 Area: 15.39 m<sup>2</sup>  
 Perimeter: 15.71 m

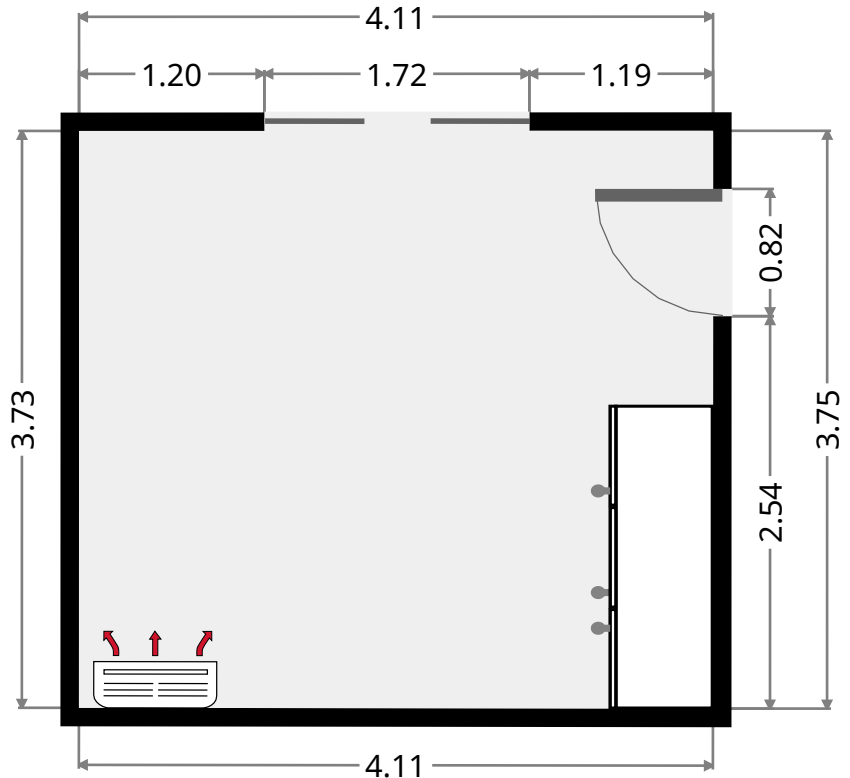
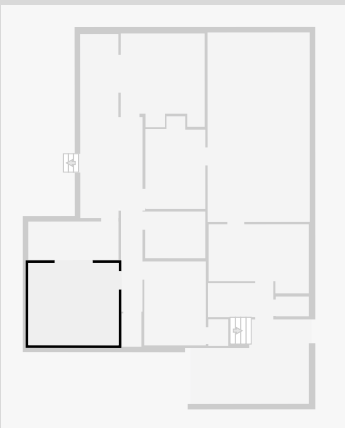

THIS FLOORPLAN IS PROVIDED WITHOUT WARRANTY OF ANY KIND. SENSOPIA DISCLAIMS ANY WARRANTY INCLUDING, WITHOUT LIMITATION, SATISFACTORY QUALITY OR ACCURACY OF DIMENSIONS.

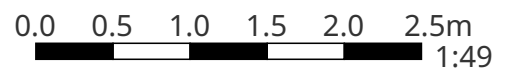

# 138 Gair Street

## Bedroom

Width: 2.81 m  
Length: 3.82 m  
Area: 10.69 m<sup>2</sup>  
Perimeter: 13.24 m

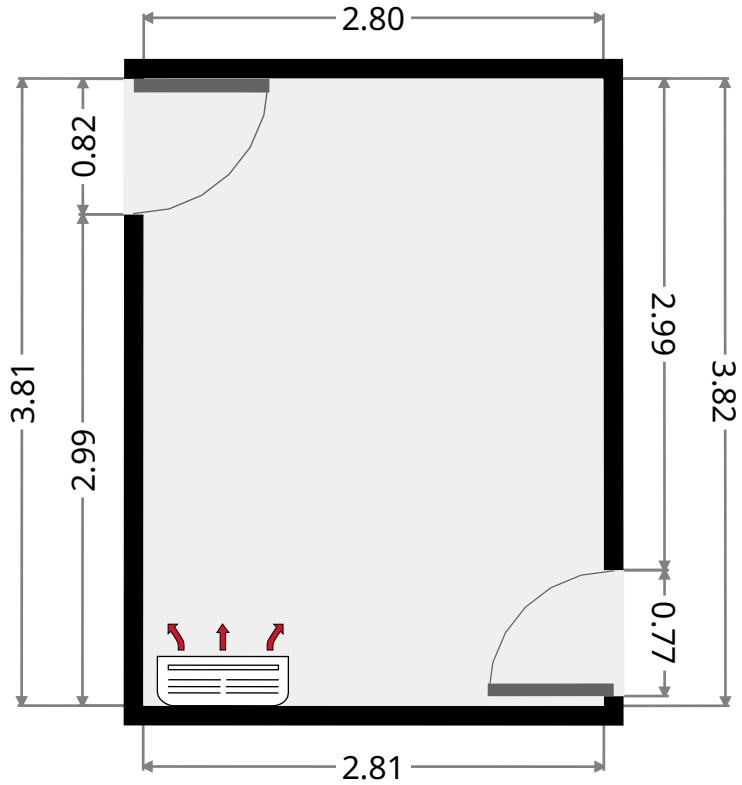
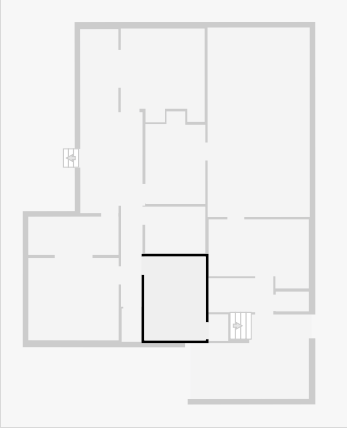

## Bathroom

Width: 2.12 m  
Length: 2.73 m  
Area: 5.81 m<sup>2</sup>  
Perimeter: 9.72 m

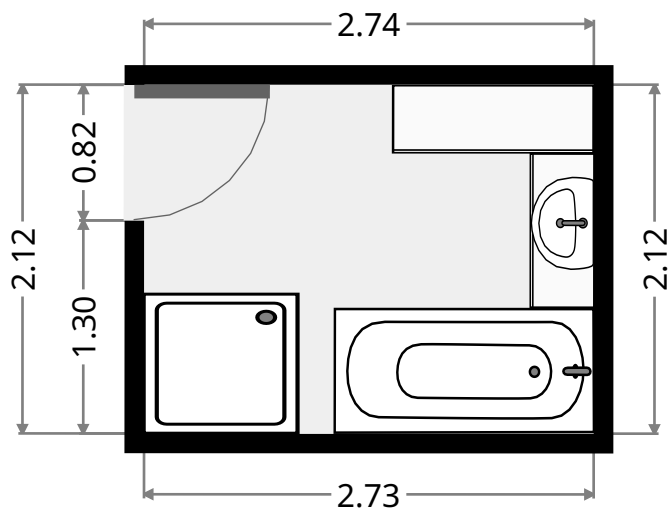
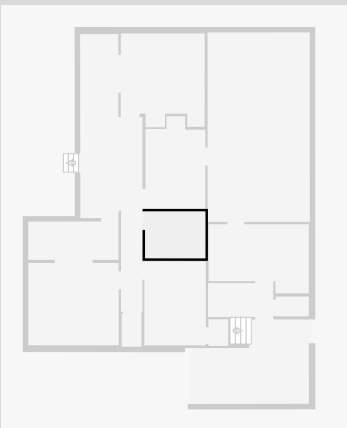

# 138 Gair Street

## Toilet

Width: 0.90 m  
 Length: 1.52 m  
 Area: 1.36 m<sup>2</sup>  
 Perimeter: 4.83 m

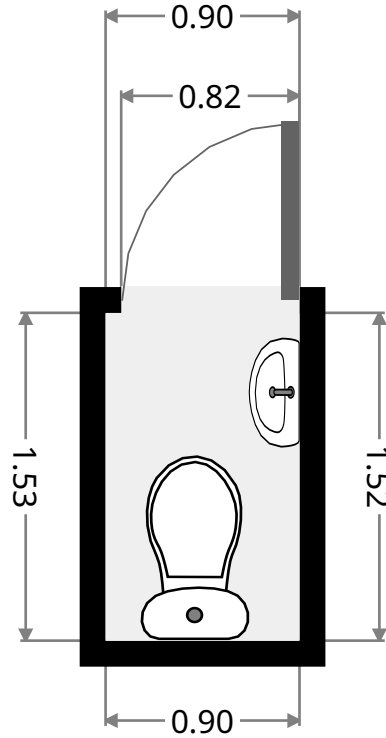
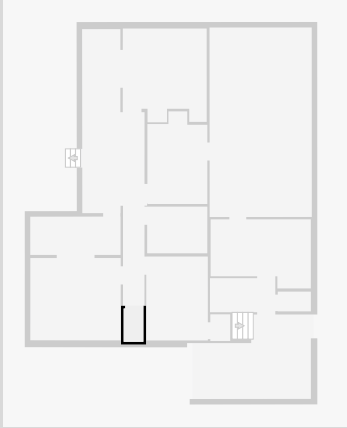

•  
 Width: 0.91 m  
 Length: 1.21 m  
 Area: 1.10 m<sup>2</sup>  
 Perimeter: 4.23 m

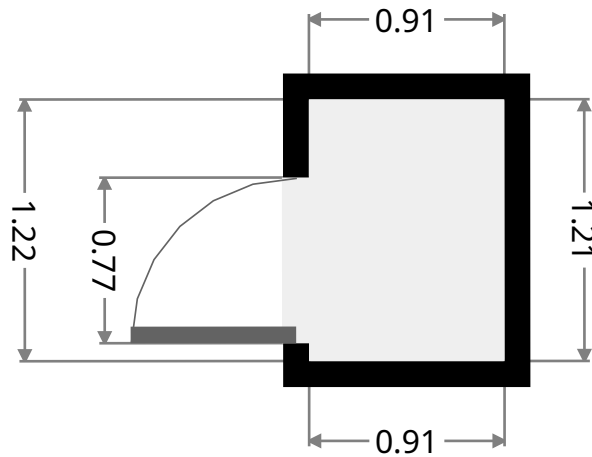
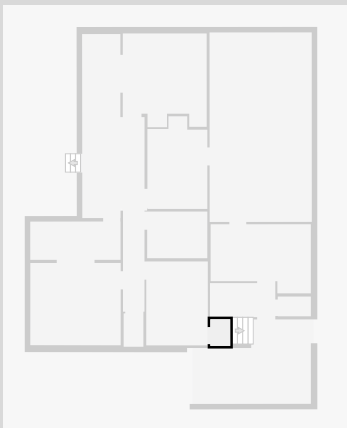

# 138 Gair Street

## Laundry Room

Width: 1.55 m  
 Length: 2.98 m  
 Area: 4.60 m<sup>2</sup>  
 Perimeter: 9.04 m

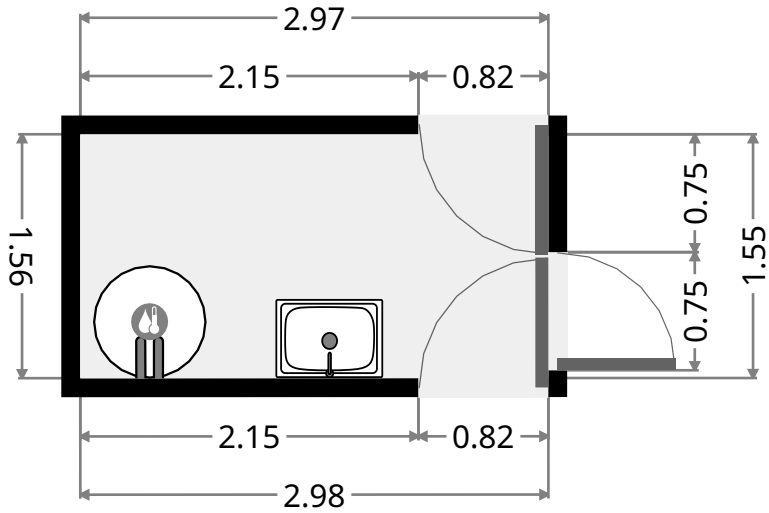
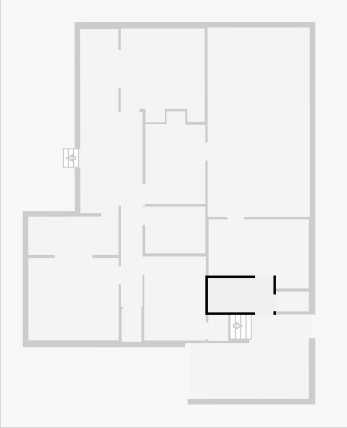

## Bedroom

Width: 3.15 m  
 Length: 4.55 m  
 Area: 12.65 m<sup>2</sup>  
 Perimeter: 15.40 m

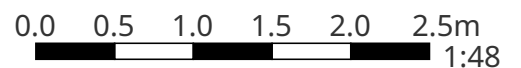
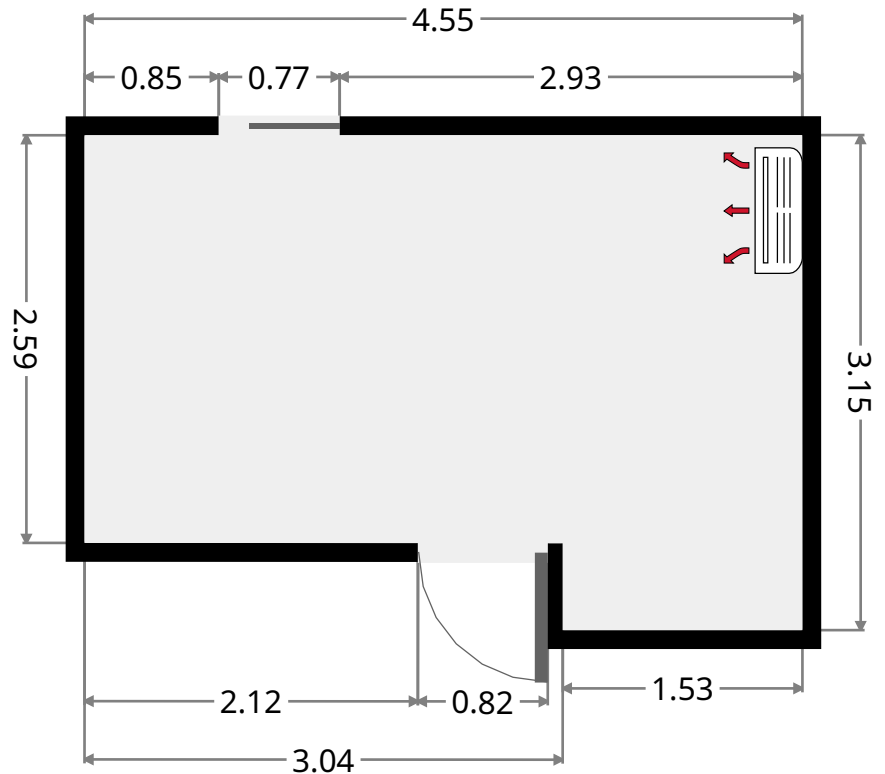
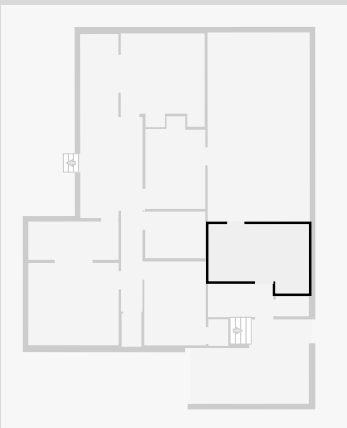

THIS FLOORPLAN IS PROVIDED WITHOUT WARRANTY OF ANY KIND. SENSOPIA DISCLAIMS ANY WARRANTY INCLUDING, WITHOUT LIMITATION, SATISFACTORY QUALITY OR ACCURACY OF DIMENSIONS.

# 138 Gair Street

## Toilet

Width: 0.90 m  
Length: 1.51 m  
Area: 1.35 m<sup>2</sup>  
Perimeter: 4.81 m

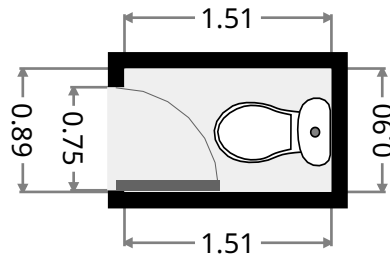
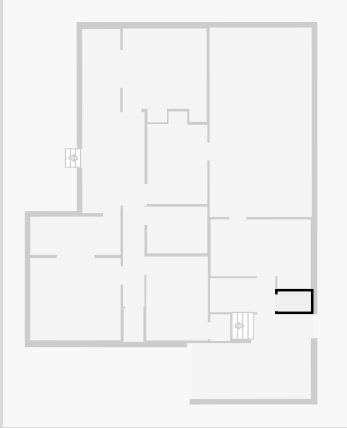

## Carport

Width: 3.84 m  
Length: 5.26 m  
Area: 16.91 m<sup>2</sup>  
Perimeter: 18.21 m

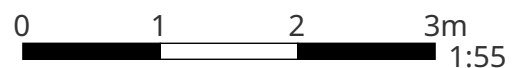
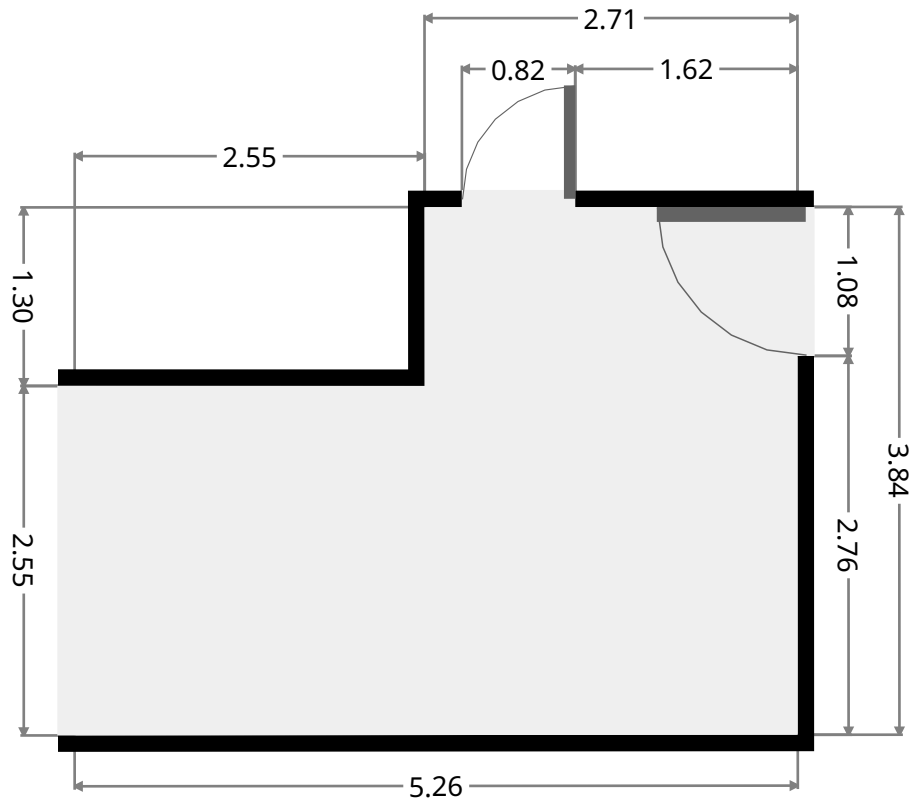
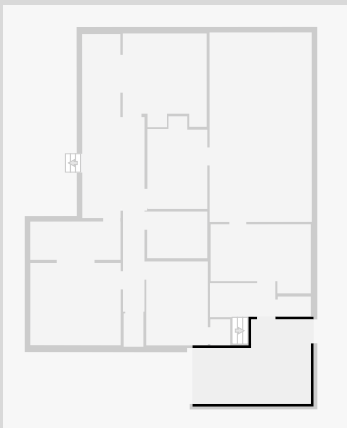

THIS FLOORPLAN IS PROVIDED WITHOUT WARRANTY OF ANY KIND. SENSOPIA DISCLAIMS ANY WARRANTY INCLUDING, WITHOUT LIMITATION, SATISFACTORY QUALITY OR ACCURACY OF DIMENSIONS.



# 138 Gair Street

## Outdoor Area

Width: 4.66 m  
Length: 8.62 m  
Area: 40.08 m<sup>2</sup>  
Perimeter: 26.54 m

