

# 131 Murphy Drive

## Ground Floor

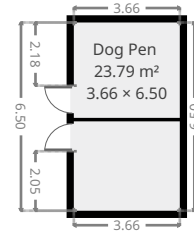

THIS FLOORPLAN IS PROVIDED WITHOUT WARRANTY OF ANY KIND. SENSOPIA DISCLAIMS ANY WARRANTY INCLUDING, WITHOUT LIMITATION, SATISFACTORY QUALITY OR ACCURACY OF DIMENSIONS.

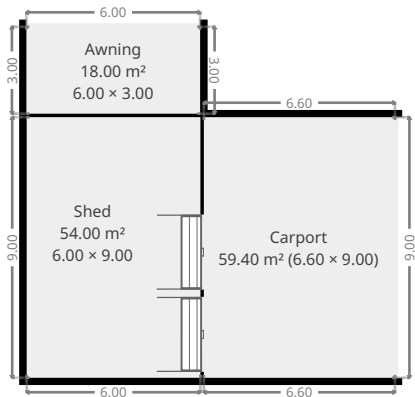
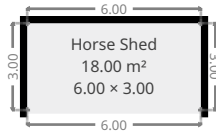

# 131 Murphy Drive

## Master Bedroom

Width: 2.98 m  
 Length: 3.62 m  
 Area: 10.61 m<sup>2</sup>  
 Perimeter: 12.88 m

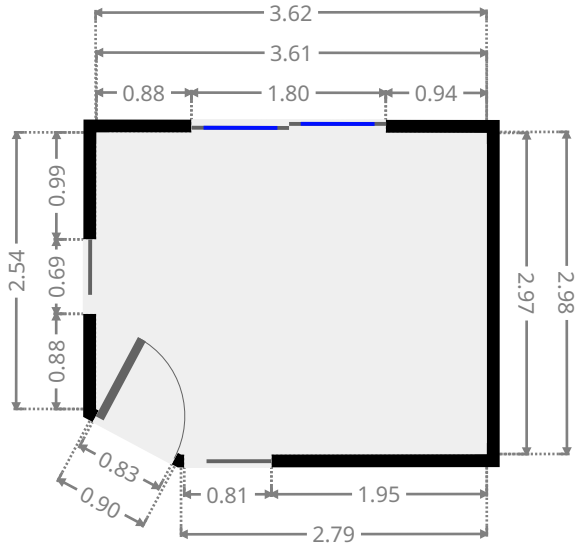
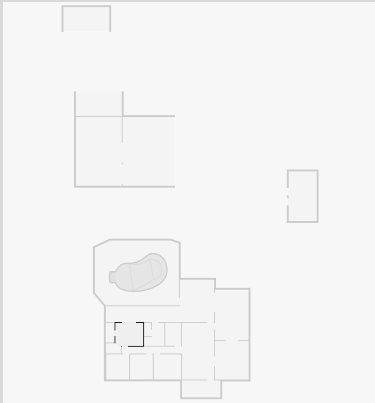

## Dog Pen

Width: 3.66 m  
 Length: 6.50 m  
 Area: 23.79 m<sup>2</sup>  
 Perimeter: 20.32 m

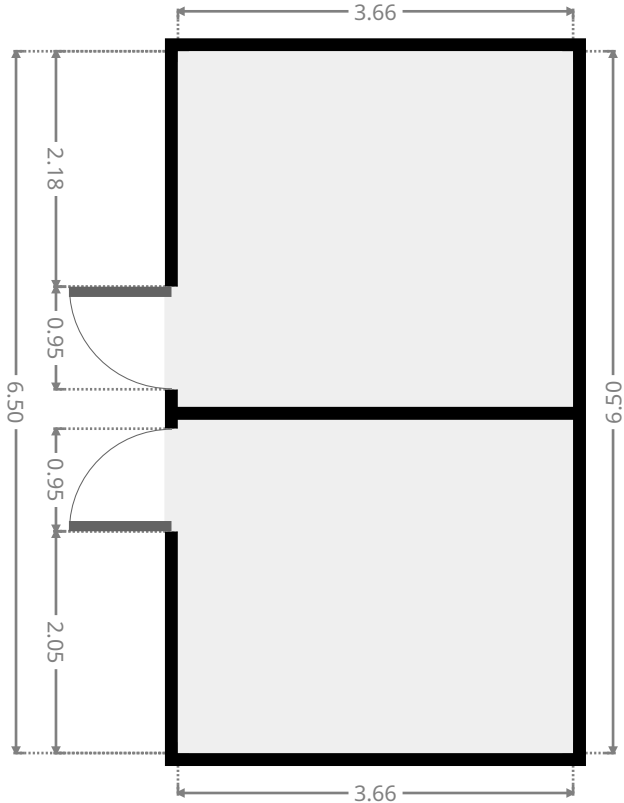
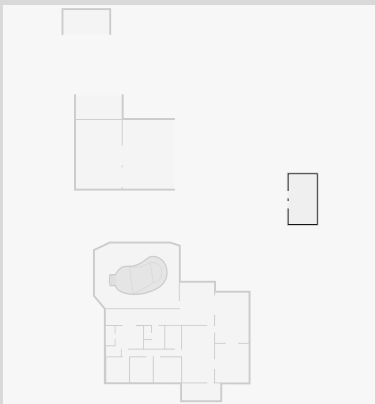

THIS FLOORPLAN IS PROVIDED WITHOUT WARRANTY OF ANY KIND. SENSOPIA DISCLAIMS ANY WARRANTY INCLUDING, WITHOUT LIMITATION, SATISFACTORY QUALITY OR ACCURACY OF DIMENSIONS.

# 131 Murphy Drive

## Horse Shed

Width: 3.00 m  
Length: 6.00 m  
Area: 18.00 m<sup>2</sup>  
Perimeter: 18.00 m

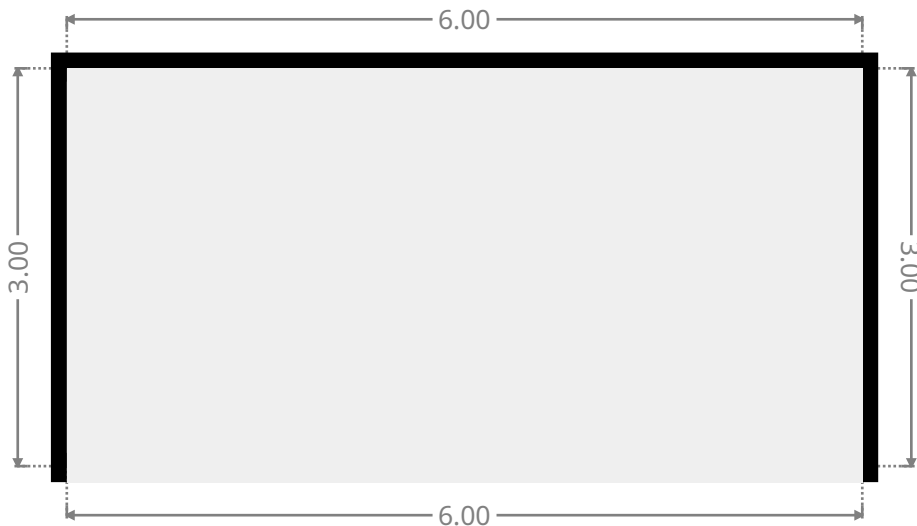
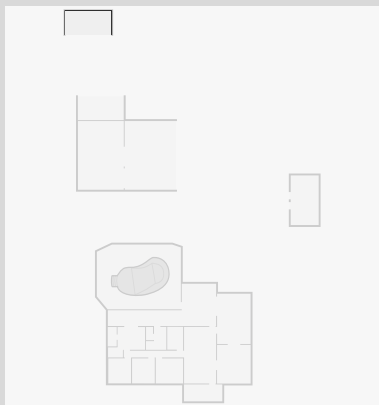

## Awning

Width: 3.00 m  
Length: 6.00 m  
Area: 18.00 m<sup>2</sup>  
Perimeter: 18.00 m

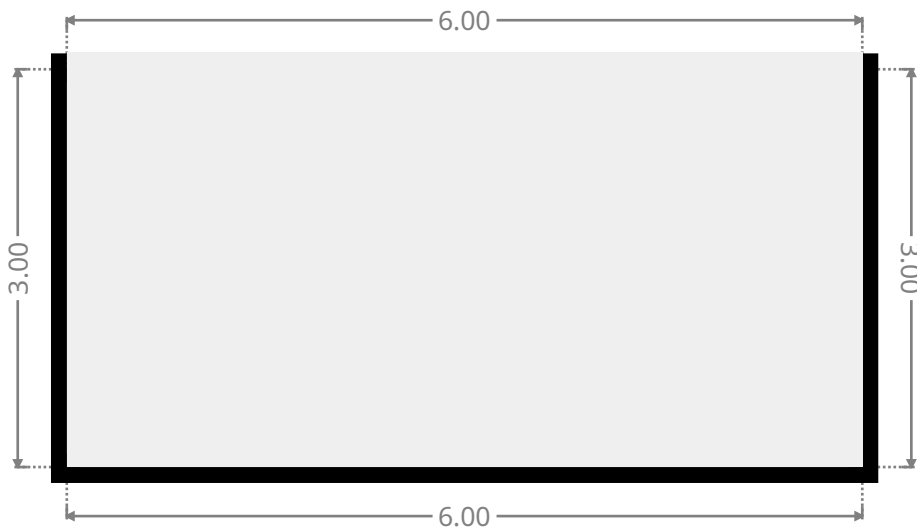
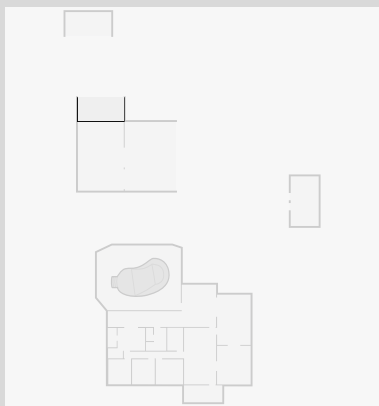

# 131 Murphy Drive

## Carport

Width: 6.60 m  
Length: 9.00 m  
Area: 59.40 m<sup>2</sup>  
Perimeter: 31.20 m

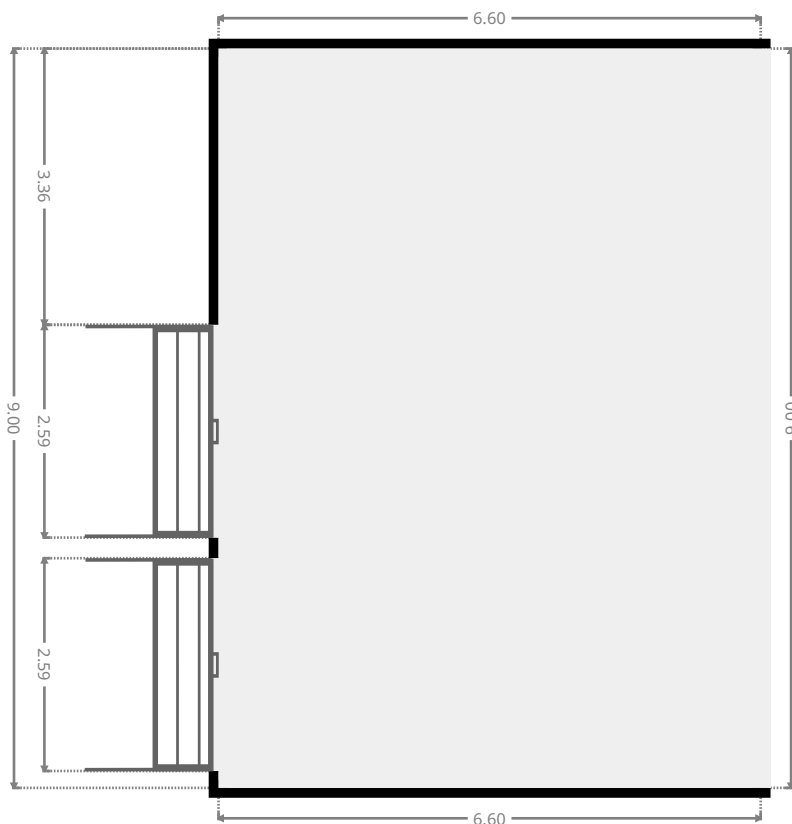
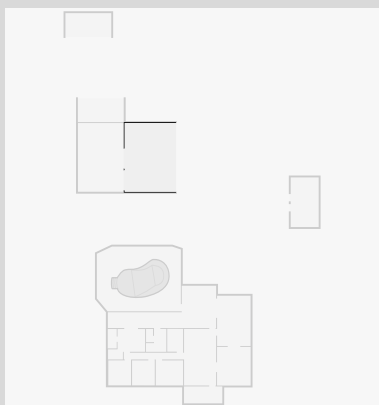

## Shed

Width: 6.00 m  
Length: 9.00 m  
Area: 54.00 m<sup>2</sup>  
Perimeter: 30.00 m

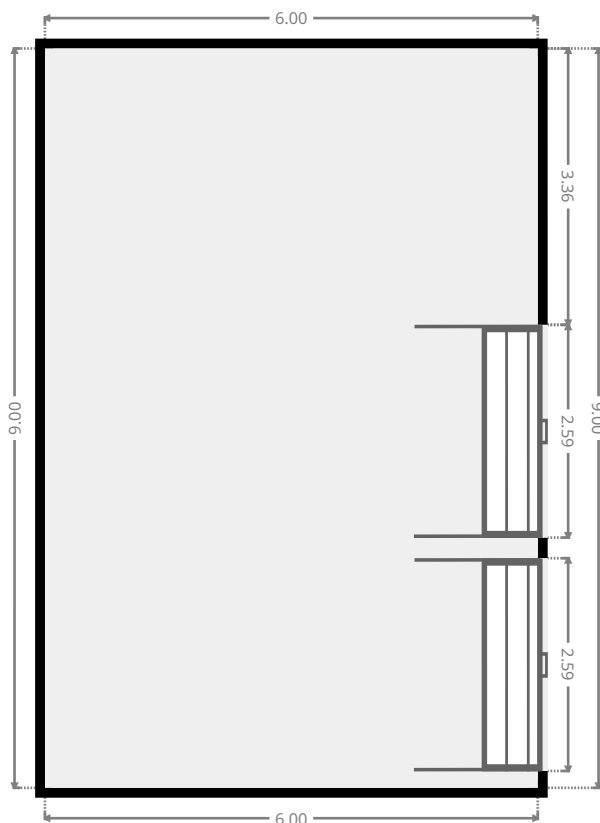
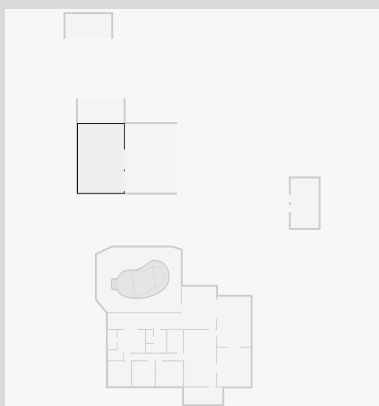

THIS FLOORPLAN IS PROVIDED WITHOUT WARRANTY OF ANY KIND. SENSOPIA DISCLAIMS ANY WARRANTY INCLUDING, WITHOUT LIMITATION, SATISFACTORY QUALITY OR ACCURACY OF DIMENSIONS.

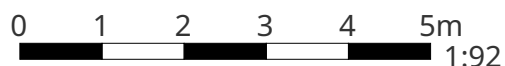

# 131 Murphy Drive

## Outdoor

Width: 8.49 m  
Length: 11.00 m  
Area: 91.03 m<sup>2</sup>  
Perimeter: 37.03 m

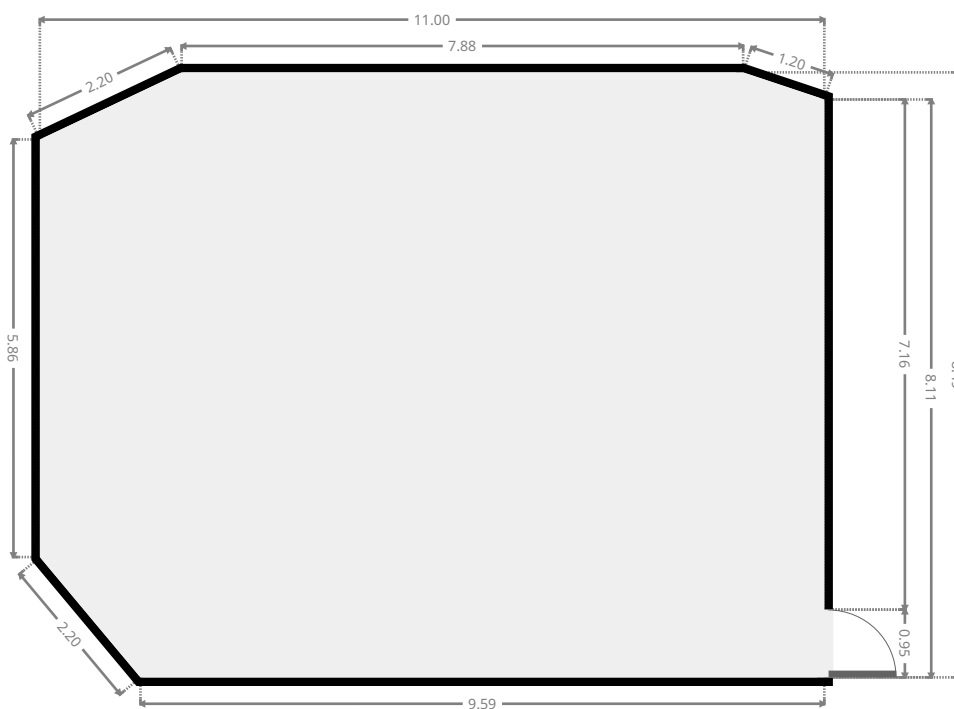
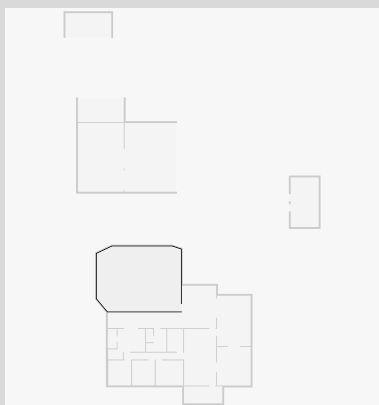

THIS FLOORPLAN IS PROVIDED WITHOUT WARRANTY OF ANY KIND. SENSOPIA DISCLAIMS ANY WARRANTY INCLUDING, WITHOUT LIMITATION, SATISFACTORY QUALITY OR ACCURACY OF DIMENSIONS.



# 131 Murphy Drive

## Outdoor Area

Width: 5.54 m  
Length: 14.18 m  
Area: 44.94 m<sup>2</sup>  
Perimeter: 39.44 m

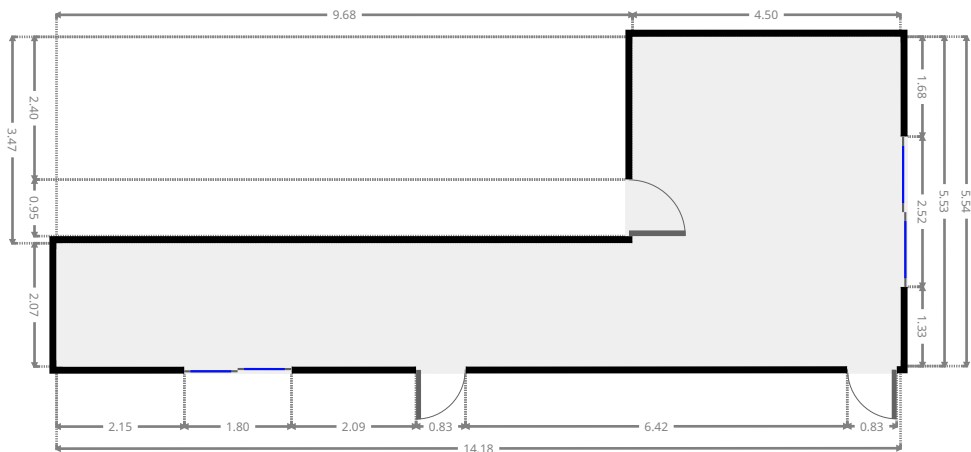
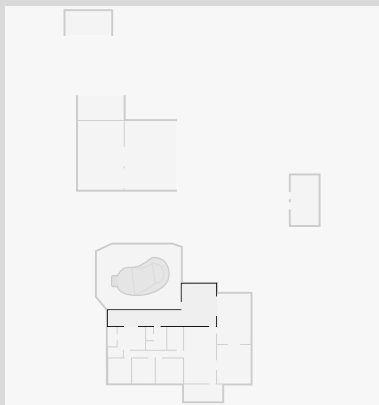

THIS FLOORPLAN IS PROVIDED WITHOUT WARRANTY OF ANY KIND. SENSOPIA DISCLAIMS ANY WARRANTY INCLUDING, WITHOUT LIMITATION, SATISFACTORY QUALITY OR ACCURACY OF DIMENSIONS.



# 131 Murphy Drive

## Other

Width: 2.22 m  
Length: 5.01 m  
Area: 11.10 m<sup>2</sup>  
Perimeter: 14.45 m

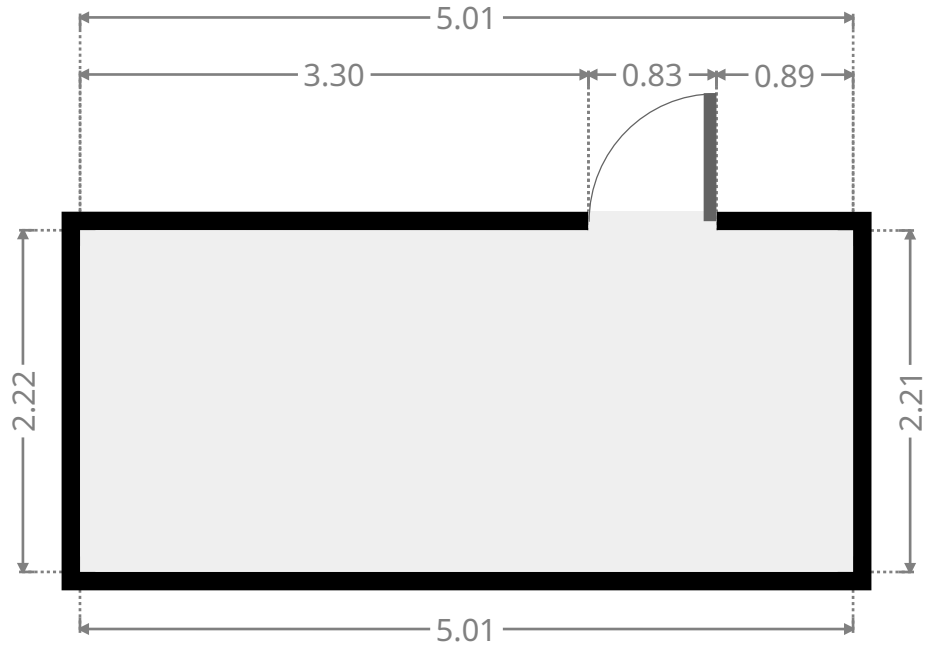
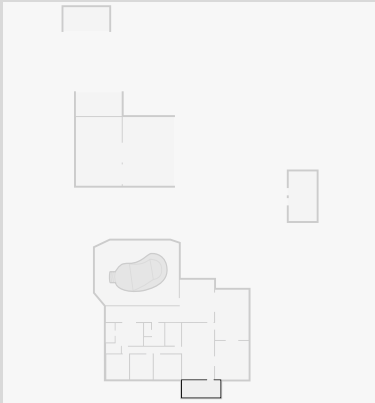

## Bathroom

Width: 1.17 m  
Length: 2.54 m  
Area: 2.98 m<sup>2</sup>  
Perimeter: 7.43 m

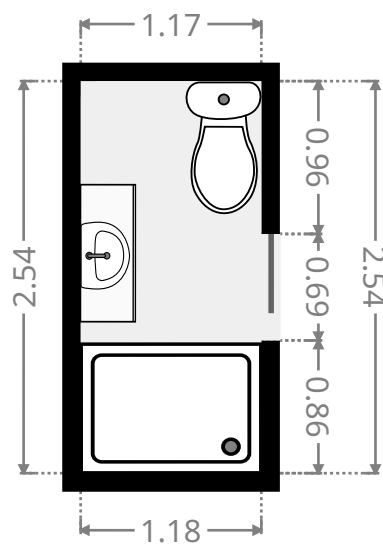
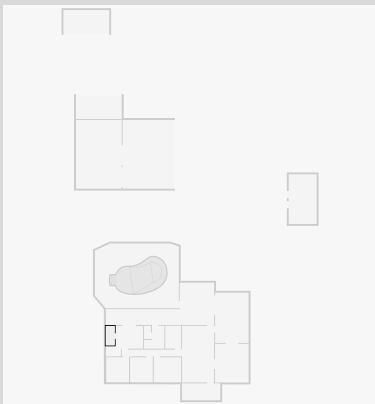

# 131 Murphy Drive

## WIR

Width: 1.33 m  
 Length: 1.95 m  
 Area: 2.42 m<sup>2</sup>  
 Perimeter: 6.24 m

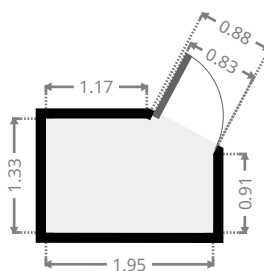
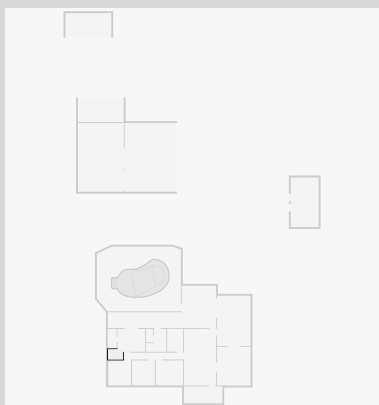

## Kitchen

Width: 4.21 m  
 Length: 7.42 m  
 Area: 31.17 m<sup>2</sup>  
 Perimeter: 23.24 m

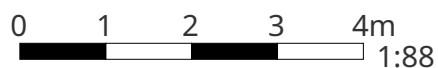
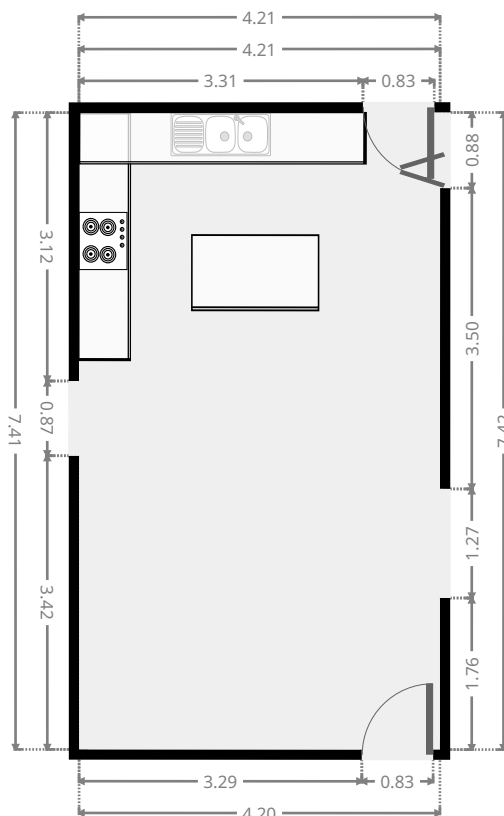
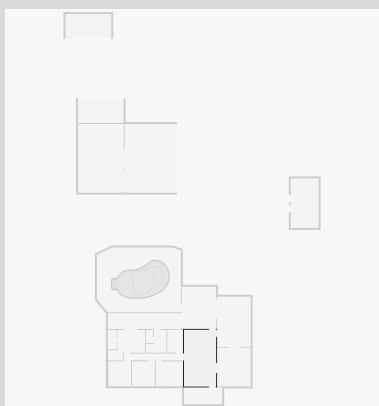

THIS FLOORPLAN IS PROVIDED WITHOUT WARRANTY OF ANY KIND. SENSOPIA DISCLAIMS ANY WARRANTY INCLUDING, WITHOUT LIMITATION, SATISFACTORY QUALITY OR ACCURACY OF DIMENSIONS.



# 131 Murphy Drive

## Bedroom

Width: 2.99 m  
 Length: 3.27 m  
 Area: 9.76 m<sup>2</sup>  
 Perimeter: 12.51 m

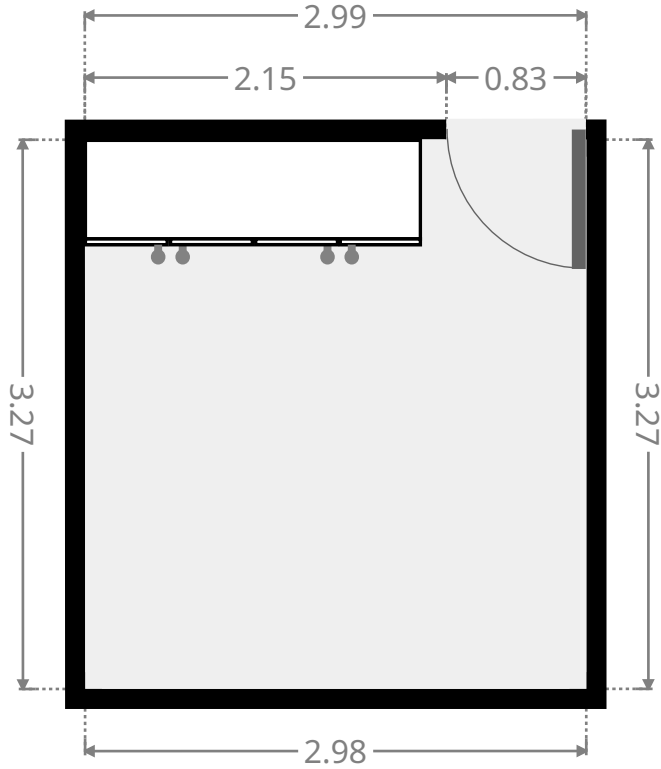
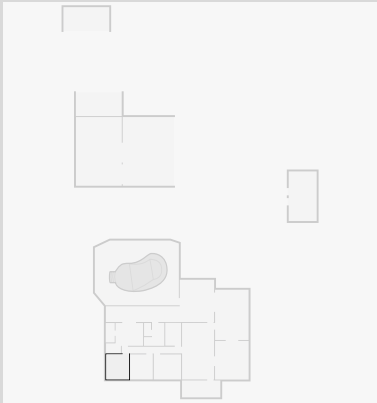

## Bedroom

Width: 2.97 m  
 Length: 3.27 m  
 Area: 9.72 m<sup>2</sup>  
 Perimeter: 12.49 m

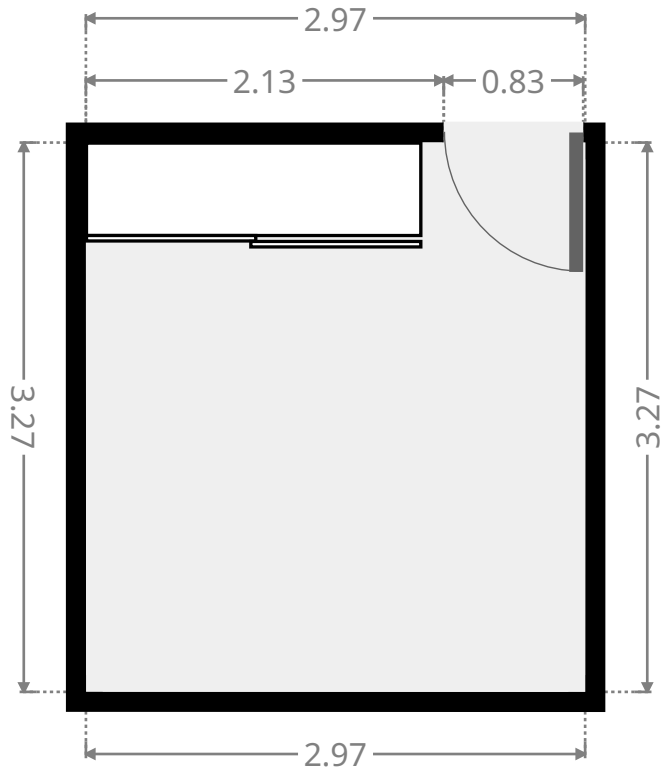
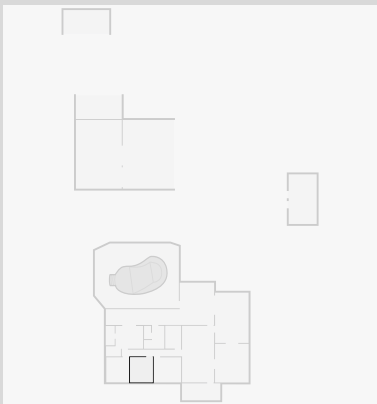

THIS FLOORPLAN IS PROVIDED WITHOUT WARRANTY OF ANY KIND. SENSOPIA DISCLAIMS ANY WARRANTY INCLUDING, WITHOUT LIMITATION, SATISFACTORY QUALITY OR ACCURACY OF DIMENSIONS.

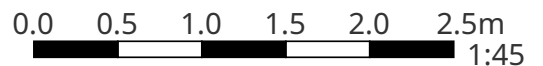

# 131 Murphy Drive

## Toilet / Half Bath

Width: 0.92 m  
 Length: 1.73 m  
 Area: 1.60 m<sup>2</sup>  
 Perimeter: 5.31 m

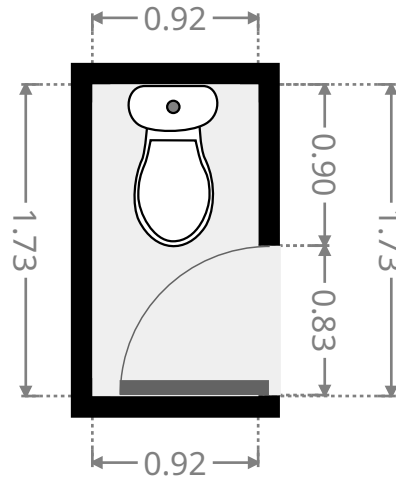
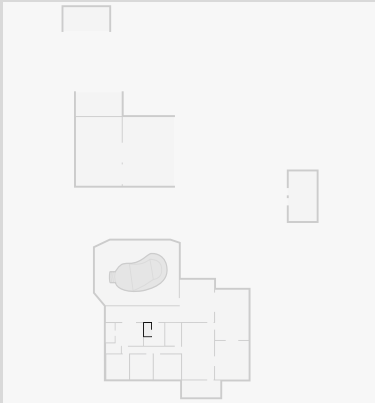

## Laundry Room

Width: 2.67 m  
 Length: 3.00 m  
 Area: 6.04 m<sup>2</sup>  
 Perimeter: 11.33 m

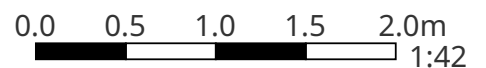
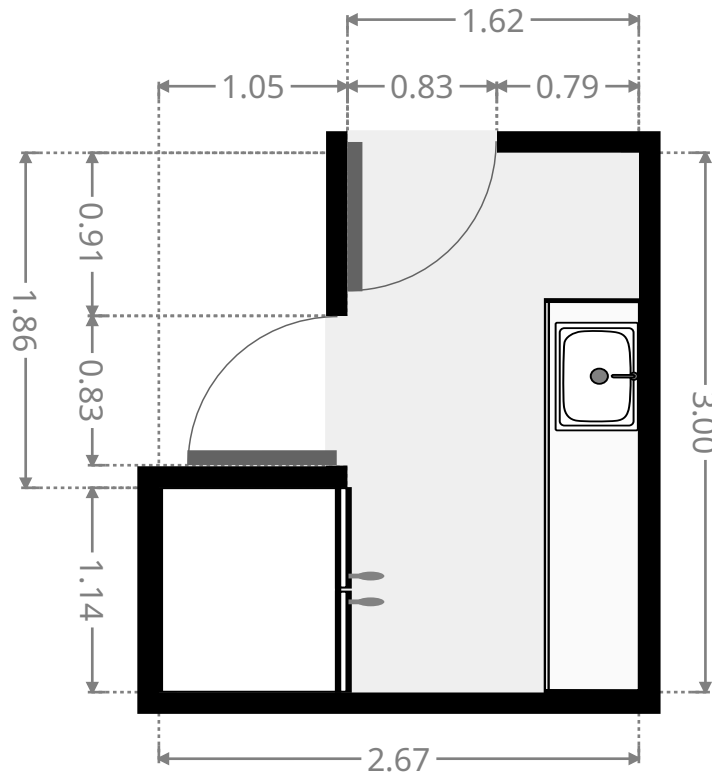
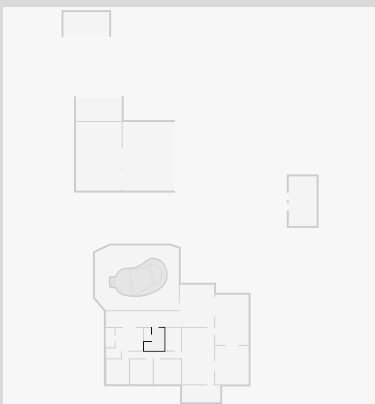

THIS FLOORPLAN IS PROVIDED WITHOUT WARRANTY OF ANY KIND. SENSOPIA DISCLAIMS ANY WARRANTY INCLUDING, WITHOUT LIMITATION, SATISFACTORY QUALITY OR ACCURACY OF DIMENSIONS.

# 131 Murphy Drive

## Bedroom

Width: 3.28 m  
Length: 3.59 m  
Area: 11.74 m<sup>2</sup>  
Perimeter: 13.72 m

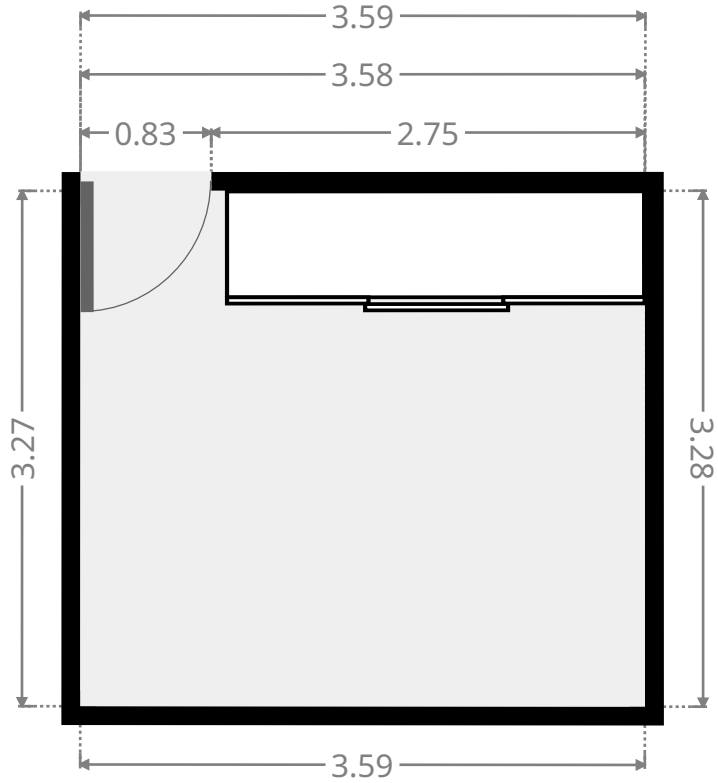
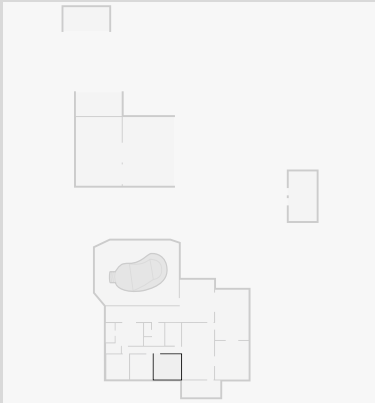

## Bathroom

Width: 2.08 m  
Length: 2.99 m  
Area: 6.22 m<sup>2</sup>  
Perimeter: 10.14 m

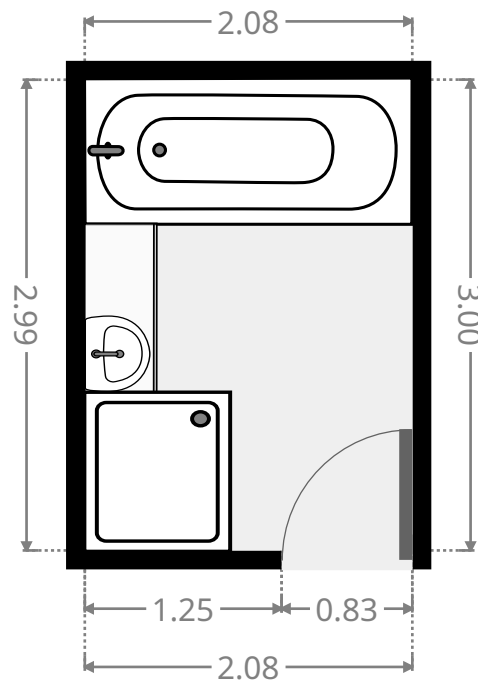
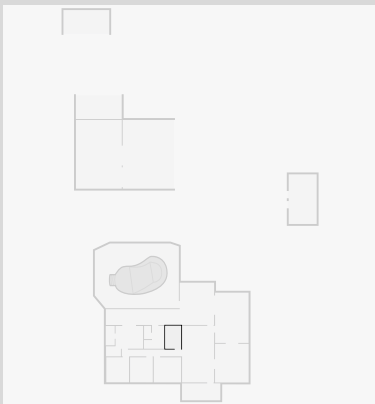

# 131 Murphy Drive

## Hall

Width: 0.88 m  
 Length: 7.78 m  
 Area: 6.88 m<sup>2</sup>  
 Perimeter: 17.33 m

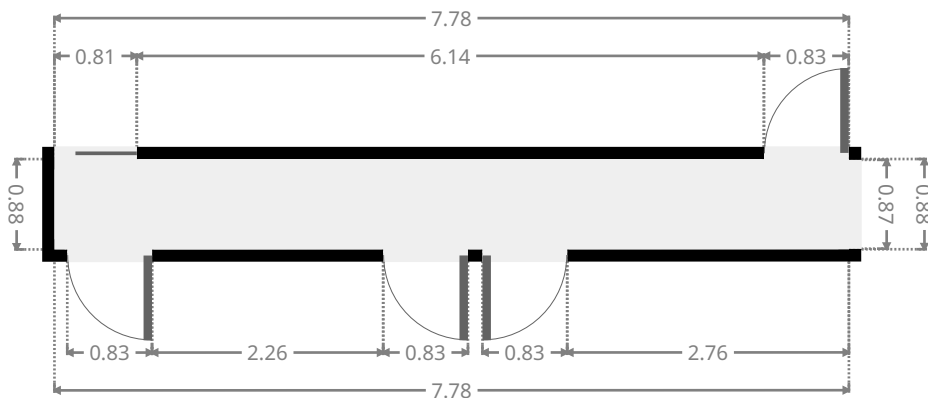
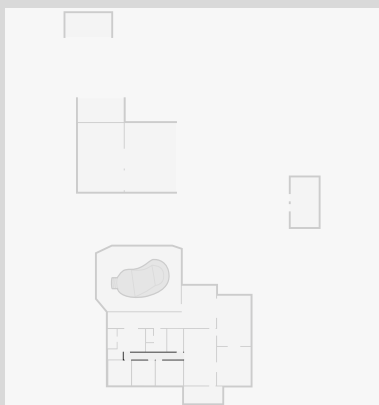

## Rumpus

Width: 4.38 m  
 Length: 6.58 m  
 Area: 28.84 m<sup>2</sup>  
 Perimeter: 21.93 m

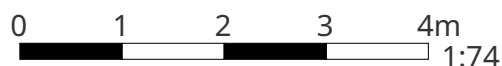
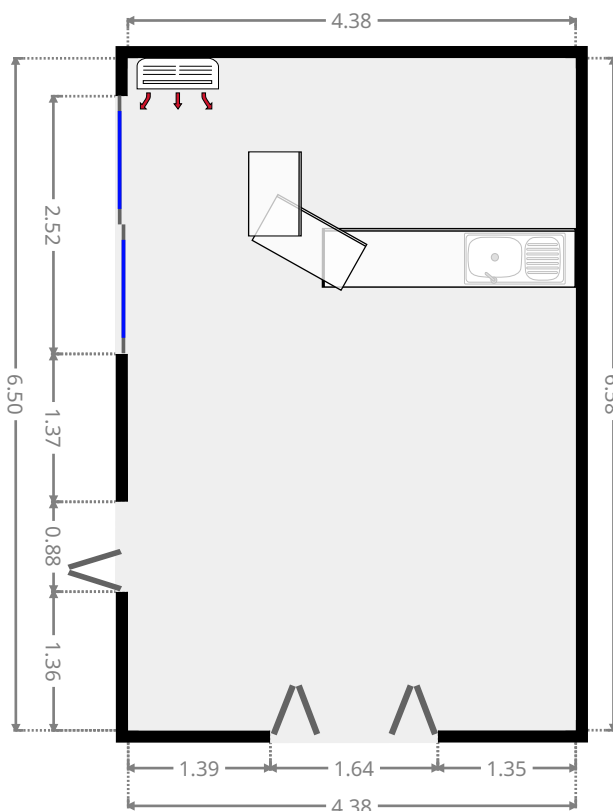
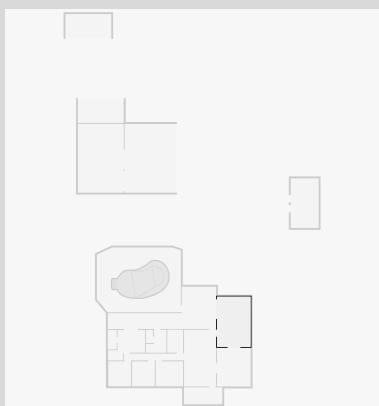

THIS FLOORPLAN IS PROVIDED WITHOUT WARRANTY OF ANY KIND. SENSOPIA DISCLAIMS ANY WARRANTY INCLUDING, WITHOUT LIMITATION, SATISFACTORY QUALITY OR ACCURACY OF DIMENSIONS.

# 131 Murphy Drive

## Living Room

Width: 4.40 m  
Length: 5.07 m  
Area: 22.30 m<sup>2</sup>  
Perimeter: 18.94 m

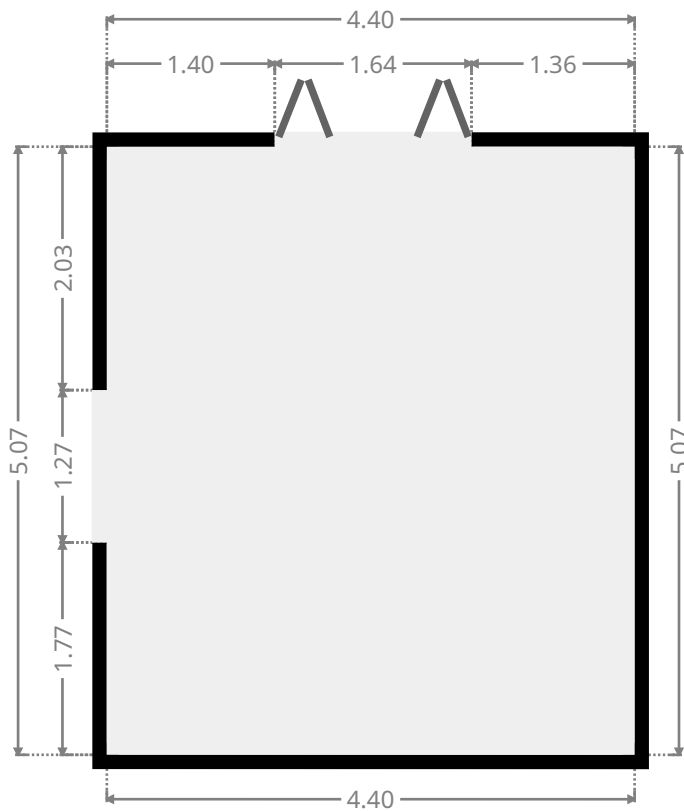
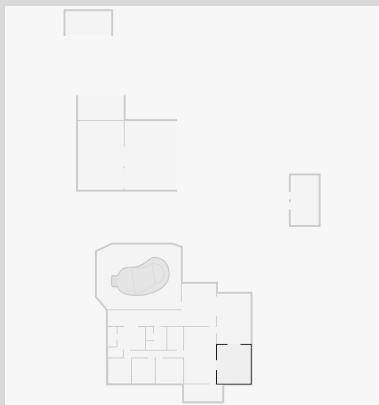

# 131 Murphy Drive



Plan  
234m2

- Plan creation date: 2019-04-18

---