

135 Gladstone Road

Ground Floor

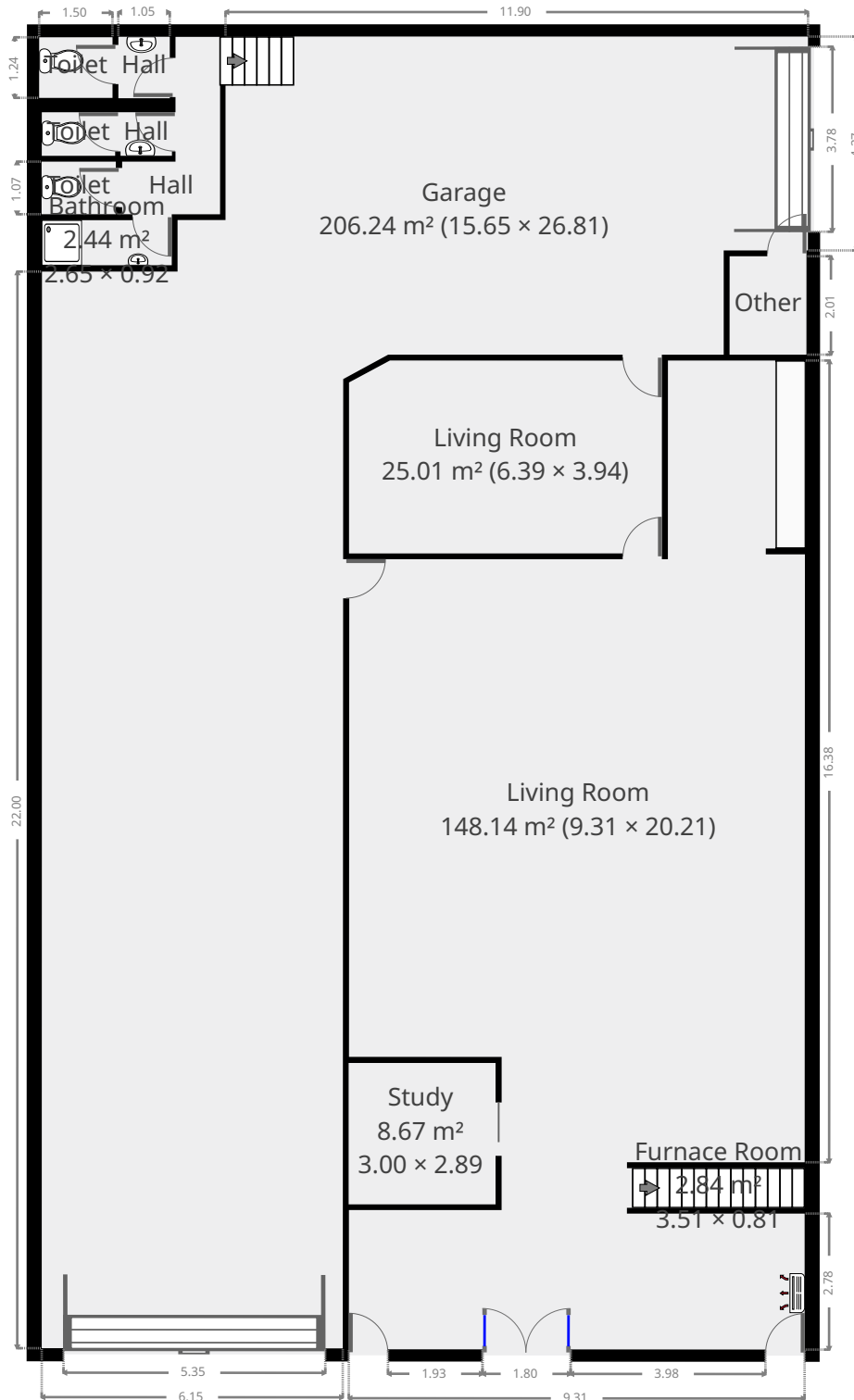

THIS FLOORPLAN IS PROVIDED WITHOUT WARRANTY OF ANY KIND. SENSOPIA DISCLAIMS ANY WARRANTY INCLUDING, WITHOUT LIMITATION, SATISFACTORY QUALITY OR ACCURACY OF DIMENSIONS.



135 Gladstone Road

Living Room

Width: 9.31 m
Length: 20.21 m
Area: 148.14 m²
Perimeter: 72.54 m

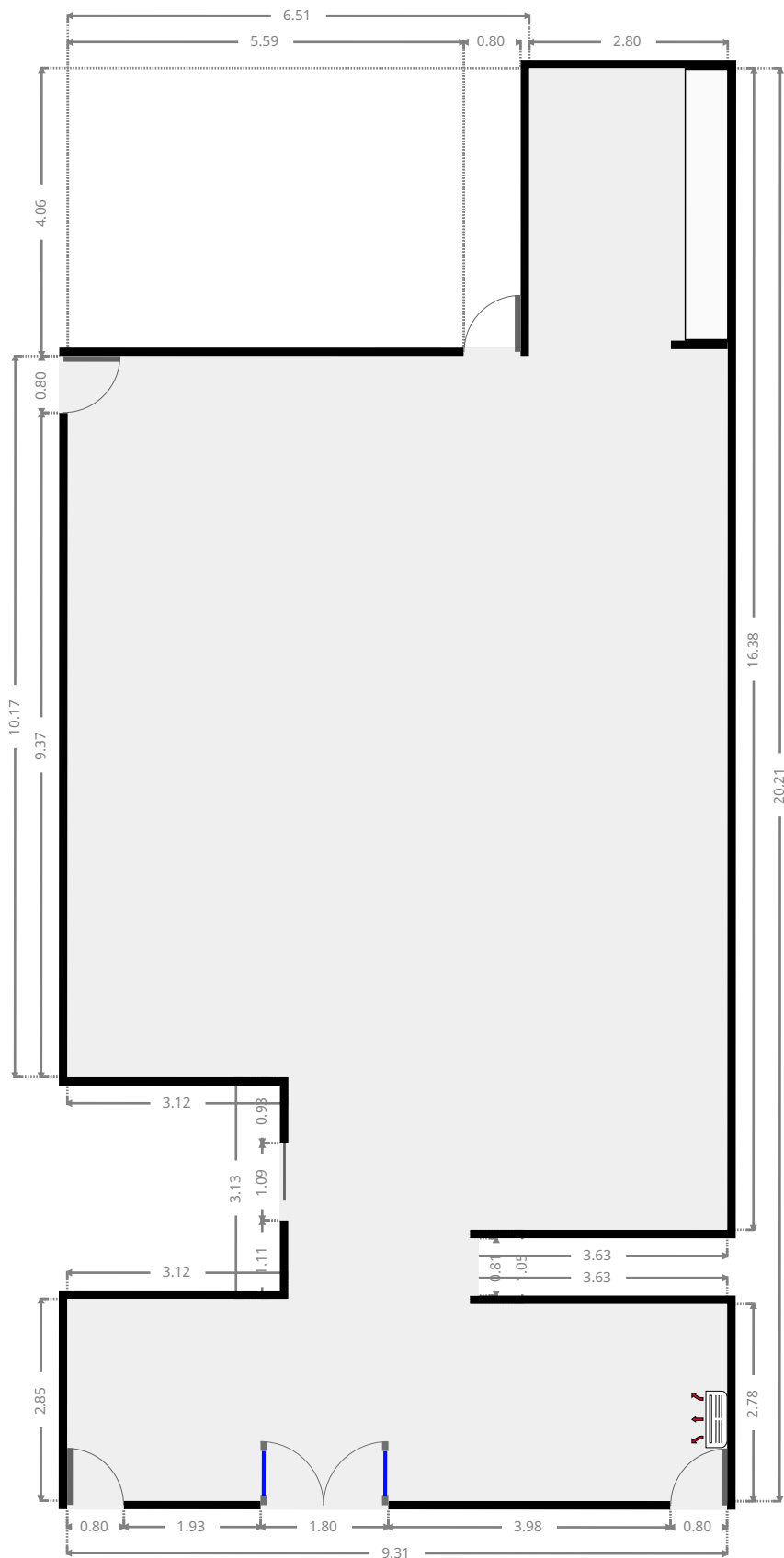
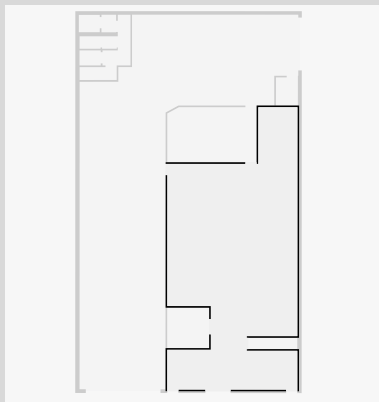

THIS FLOORPLAN IS PROVIDED WITHOUT WARRANTY OF ANY KIND. SENSOPIA DISCLAIMS ANY WARRANTY INCLUDING, WITHOUT LIMITATION, SATISFACTORY QUALITY OR ACCURACY OF DIMENSIONS.



135 Gladstone Road

Study

Width: 2.89 m
Length: 3.00 m
Area: 8.67 m²
Perimeter: 11.78 m

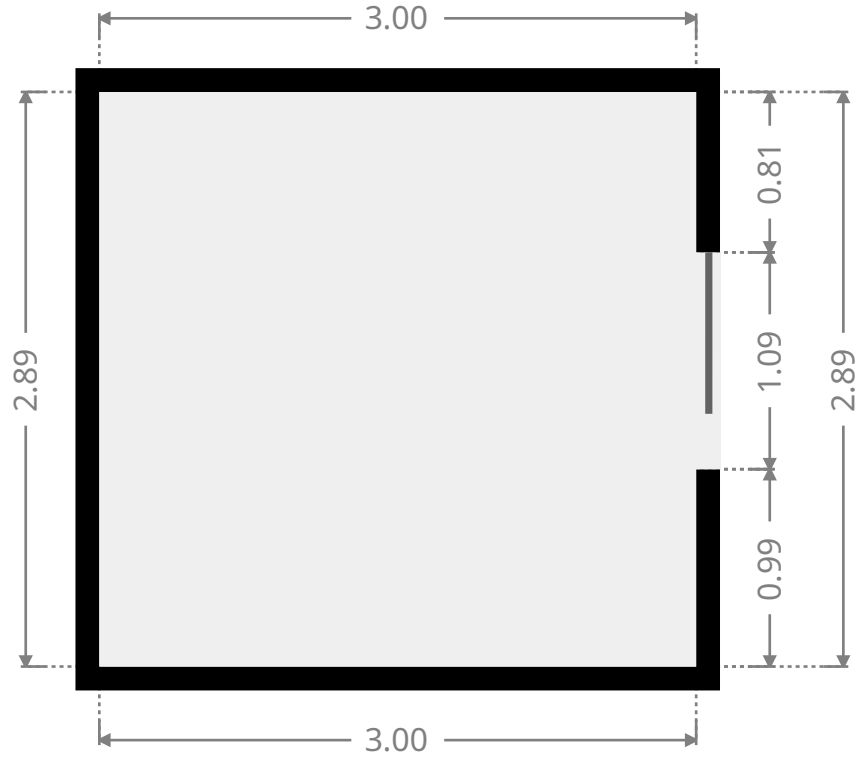
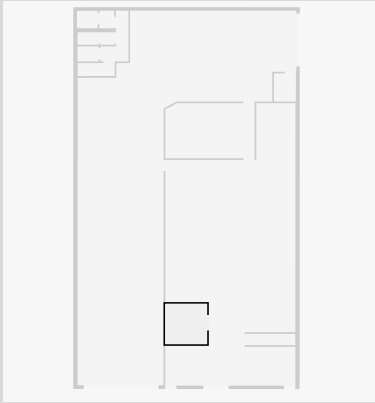

Furnace Room

Width: 0.81 m
Length: 3.51 m
Area: 2.84 m²
Perimeter: 8.64 m

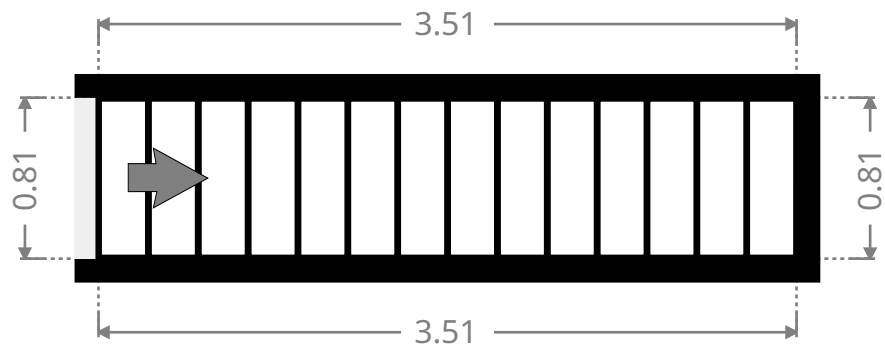
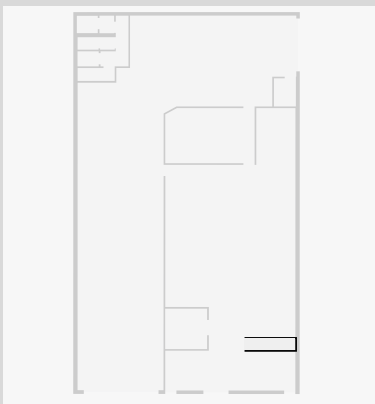

135 Gladstone Road

Living Room

Width: 3.94 m
Length: 6.39 m
Area: 25.01 m²
Perimeter: 20.33 m

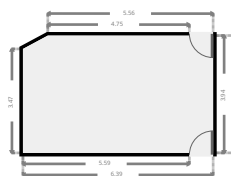
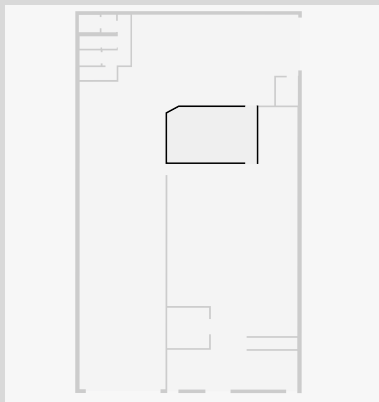

Garage

Width: 15.65 m
Length: 26.81 m
Area: 206.24 m²
Perimeter: 84.53 m

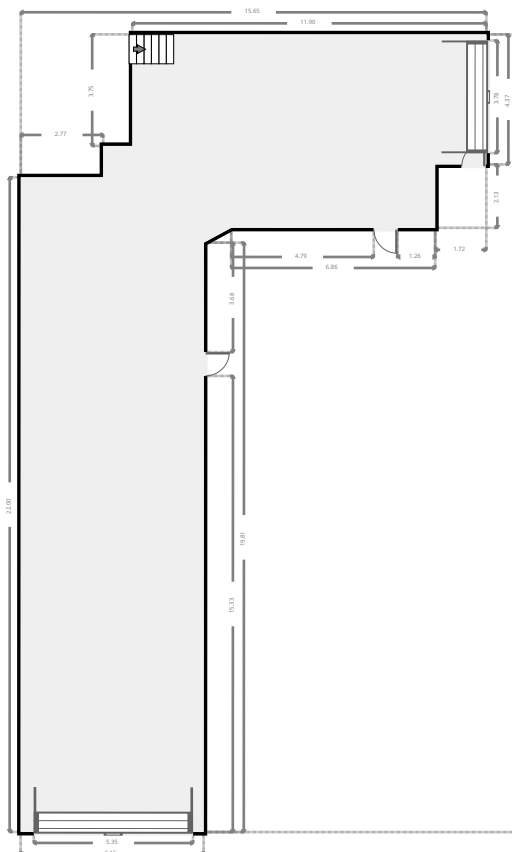
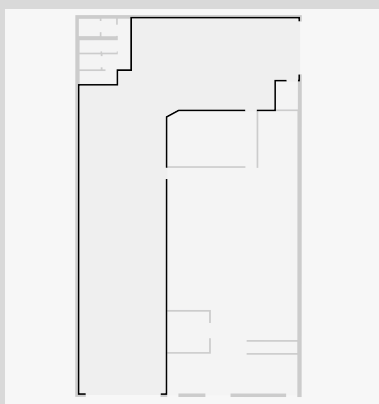

THIS FLOORPLAN IS PROVIDED WITHOUT WARRANTY OF ANY KIND. SENSOPIA DISCLAIMS ANY WARRANTY INCLUDING, WITHOUT LIMITATION, SATISFACTORY QUALITY OR ACCURACY OF DIMENSIONS.

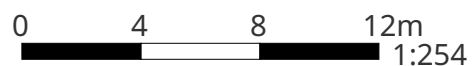

135 Gladstone Road

Hall

Width: 2.00 m
Length: 3.62 m
Area: 4.47 m²
Perimeter: 11.25 m

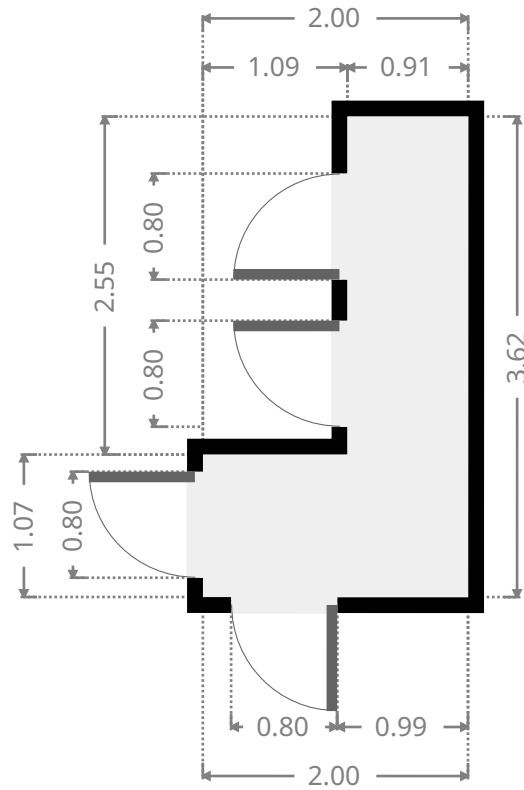
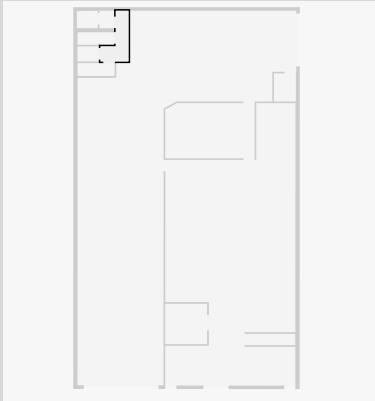

Bathroom

Width: 0.92 m
Length: 2.65 m
Area: 2.44 m²
Perimeter: 7.14 m

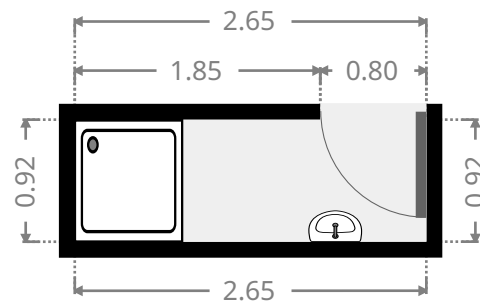
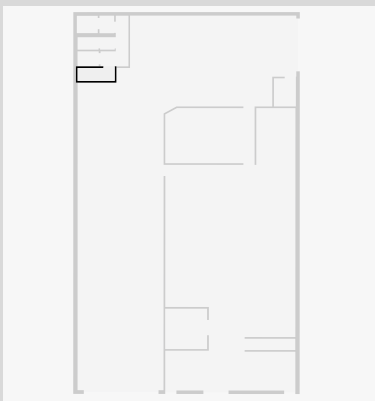

135 Gladstone Road

Toilet / Half Bath

Width: 1.07 m
Length: 1.52 m
Area: 1.63 m²
Perimeter: 5.18 m

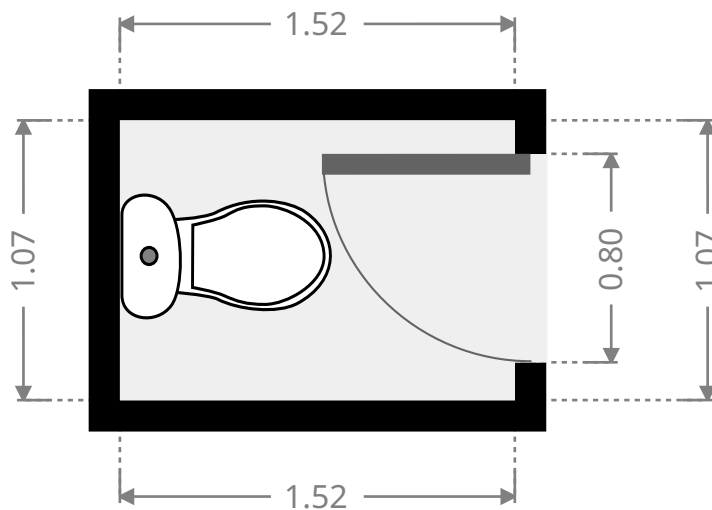
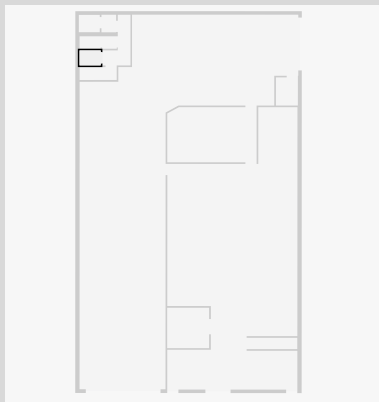

Hall

Width: 0.89 m
Length: 1.05 m
Area: 0.93 m²
Perimeter: 3.88 m

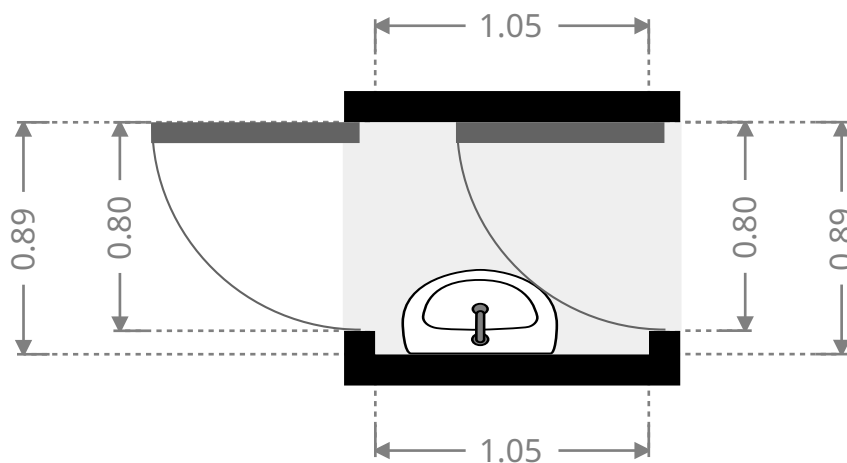
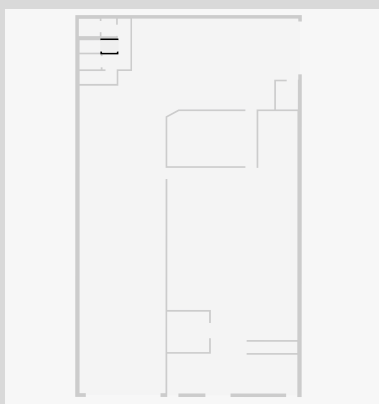

THIS FLOORPLAN IS PROVIDED WITHOUT WARRANTY OF ANY KIND. SENSOPIA DISCLAIMS ANY WARRANTY INCLUDING, WITHOUT LIMITATION, SATISFACTORY QUALITY OR ACCURACY OF DIMENSIONS.

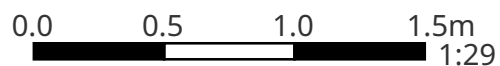

135 Gladstone Road

Toilet / Half Bath

Width: 0.89 m
Length: 1.50 m
Area: 1.33 m²
Perimeter: 4.78 m

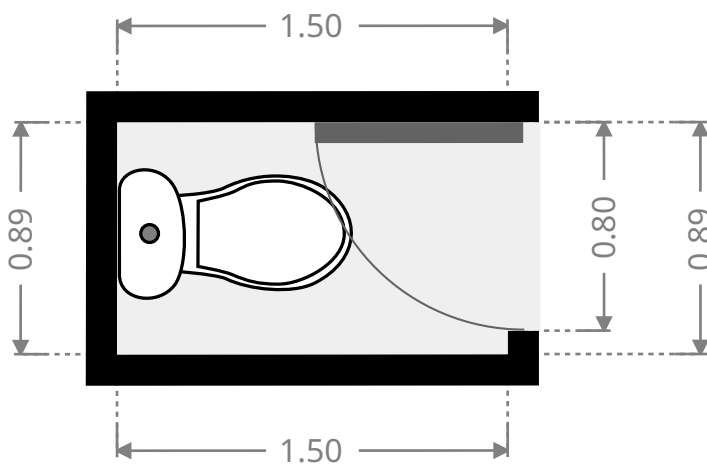
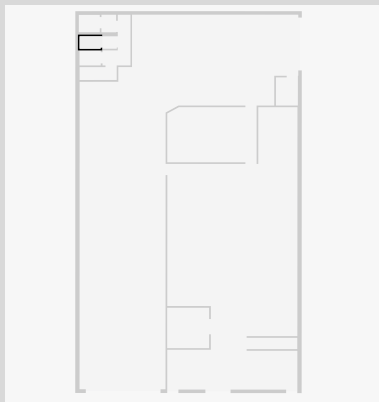

Hall

Width: 1.05 m
Length: 1.26 m
Area: 1.32 m²
Perimeter: 4.61 m

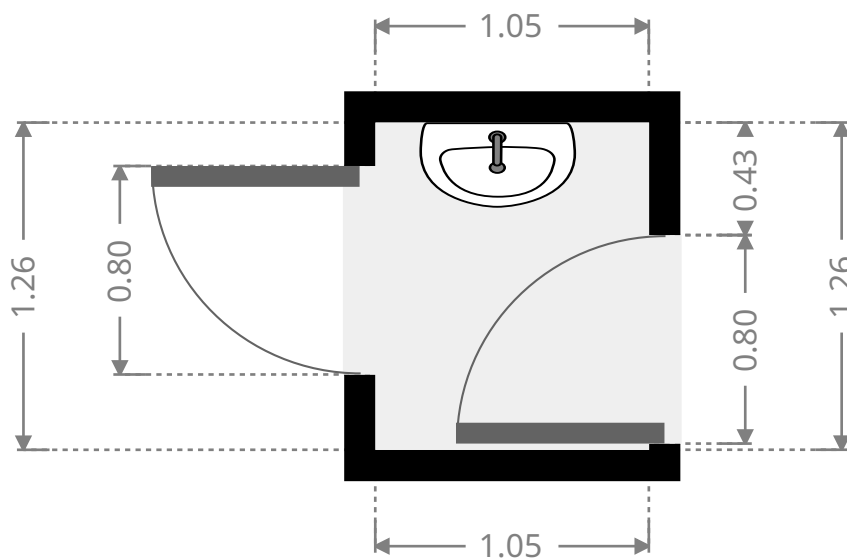
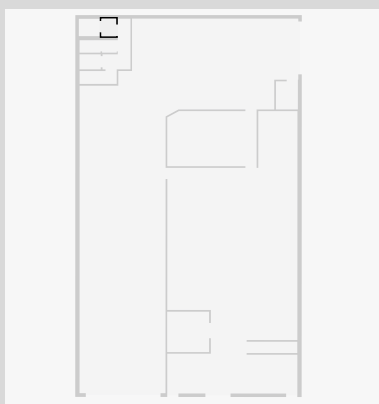

THIS FLOORPLAN IS PROVIDED WITHOUT WARRANTY OF ANY KIND. SENSOPIA DISCLAIMS ANY WARRANTY INCLUDING, WITHOUT LIMITATION, SATISFACTORY QUALITY OR ACCURACY OF DIMENSIONS.

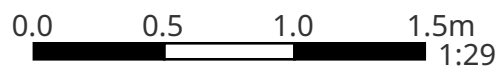

135 Gladstone Road

Toilet / Half Bath

Width: 1.24 m
Length: 1.50 m
Area: 1.86 m²
Perimeter: 5.47 m

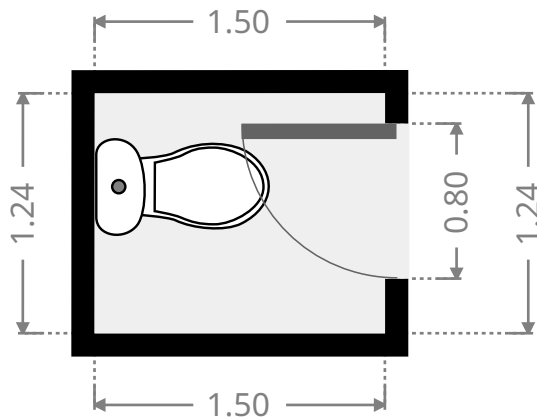
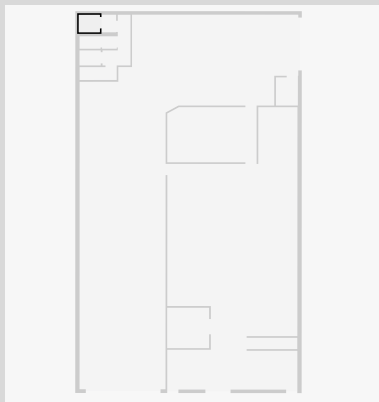

Other

Width: 1.57 m
Length: 2.01 m
Area: 3.16 m²
Perimeter: 7.16 m

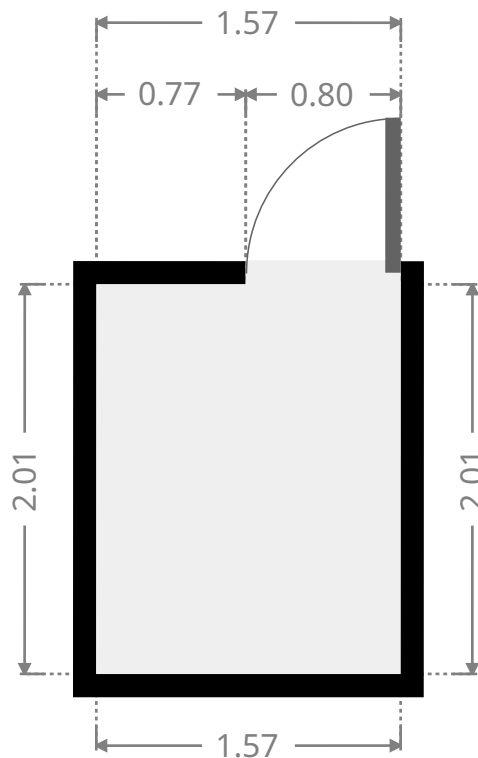
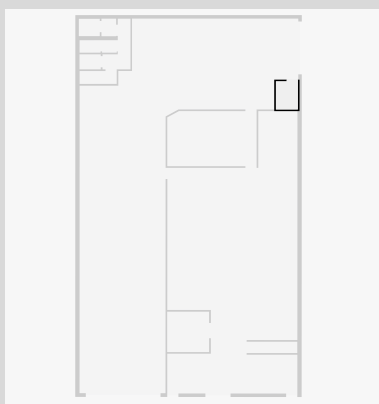

THIS FLOORPLAN IS PROVIDED WITHOUT WARRANTY OF ANY KIND. SENSOPIA DISCLAIMS ANY WARRANTY INCLUDING, WITHOUT LIMITATION, SATISFACTORY QUALITY OR ACCURACY OF DIMENSIONS.

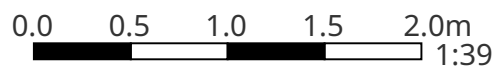

135 Gladstone Road

1st Floor

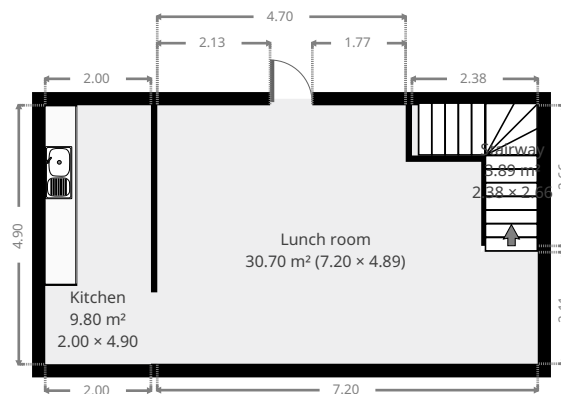

THIS FLOORPLAN IS PROVIDED WITHOUT WARRANTY OF ANY KIND. SENSOPIA DISCLAIMS ANY WARRANTY INCLUDING, WITHOUT LIMITATION, SATISFACTORY QUALITY OR ACCURACY OF DIMENSIONS.



135 Gladstone Road

Lunch room

Width: 4.89 m
 Length: 7.20 m
 Area: 30.70 m²
 Perimeter: 24.18 m

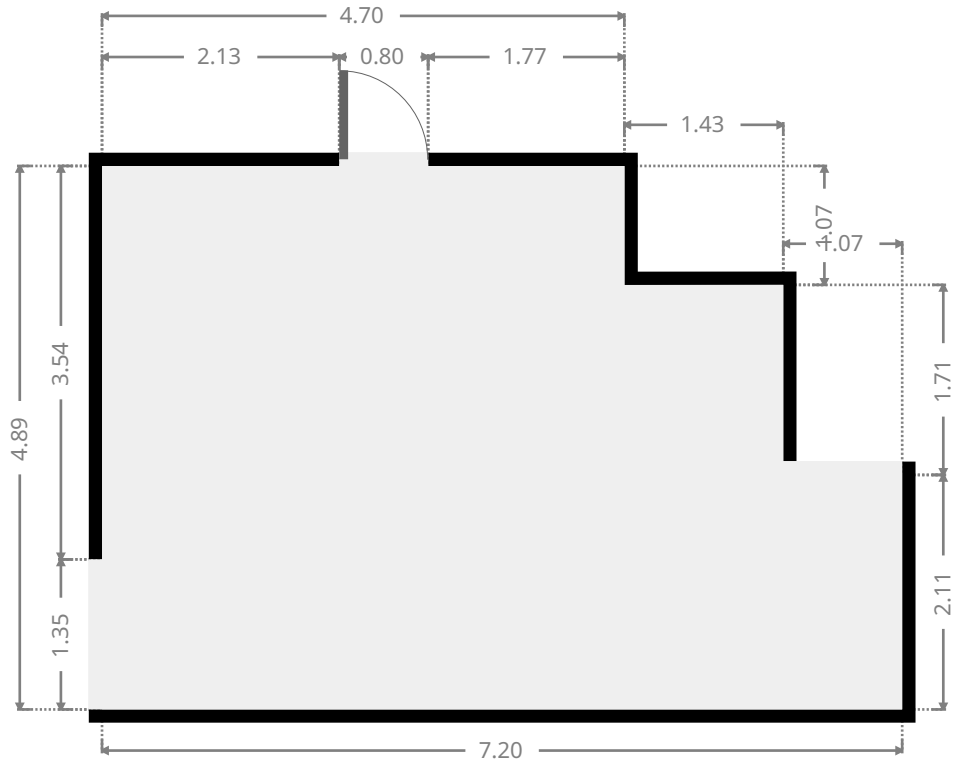
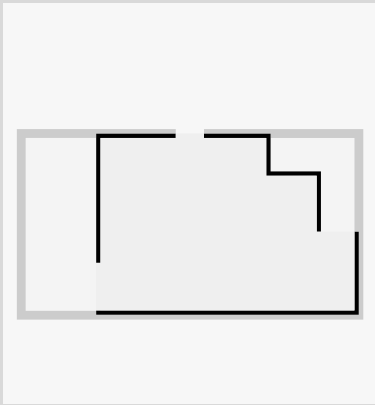

Kitchen

Width: 2.00 m
 Length: 4.90 m
 Area: 9.80 m²
 Perimeter: 13.80 m

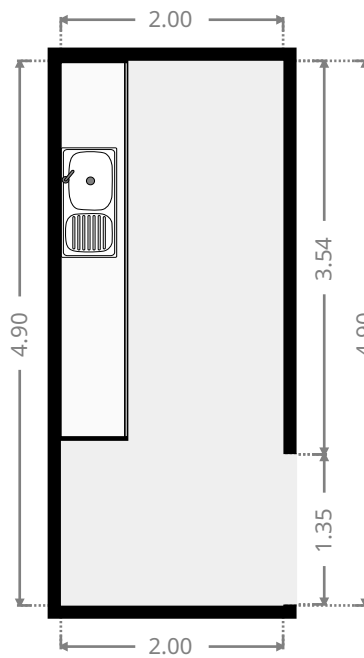
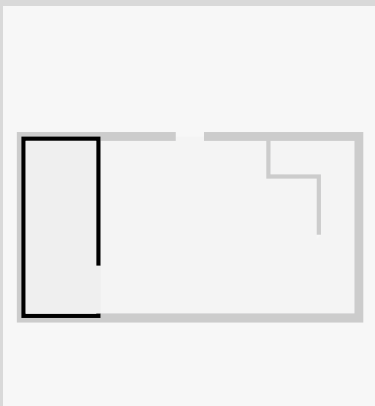

THIS FLOORPLAN IS PROVIDED WITHOUT WARRANTY OF ANY KIND. SENSOPIA DISCLAIMS ANY WARRANTY INCLUDING, WITHOUT LIMITATION, SATISFACTORY QUALITY OR ACCURACY OF DIMENSIONS.

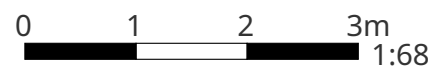

135 Gladstone Road

Stairway

Width:	2.38 m
Length:	2.66 m
Area	3.89 m ²
Perimeter	10.08 m

