

# 134 Elphinstone street

**SUBMITTED BY**

Ray White Rockhampton Casey  
stockers@cqoz.com

---

**CREATED ON**

2022-03-02

---

**Floors**

1

---

▼ Ground Floor

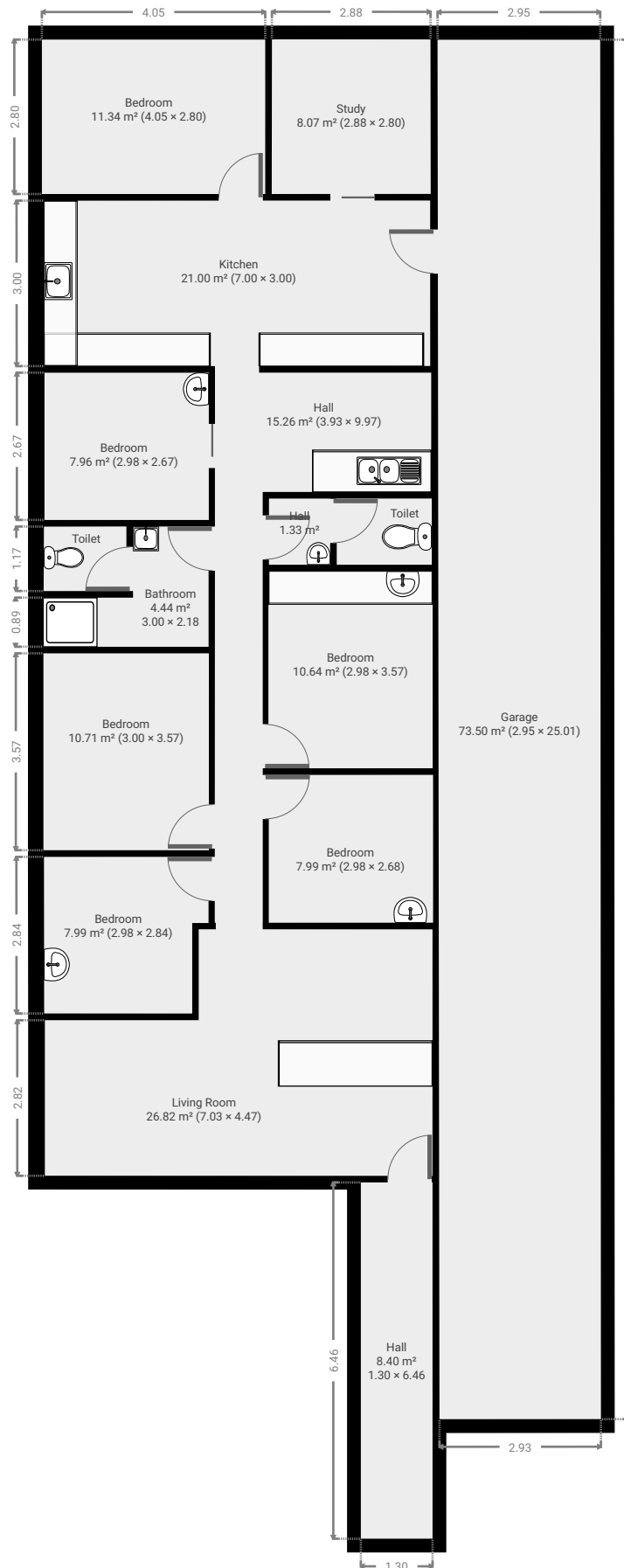

▼ Living Room  
Ground Floor

WIDTH: 7.03 m • LENGTH: 4.47 m  
AREA: 26.82 m<sup>2</sup> • PERIMETER: 23.00 m

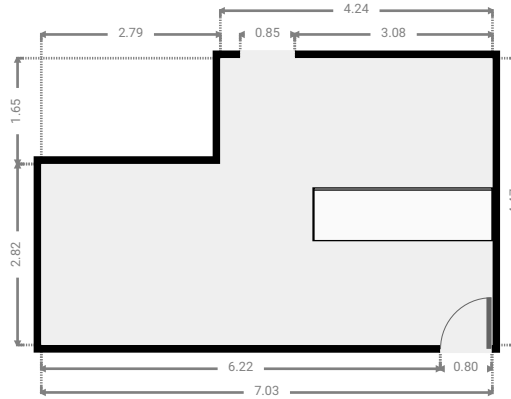
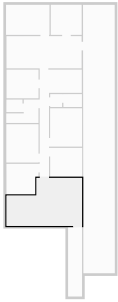

▼ Hall  
Ground Floor

WIDTH: 3.93 m • LENGTH: 9.97 m  
AREA: 15.26 m<sup>2</sup> • PERIMETER: 27.80 m

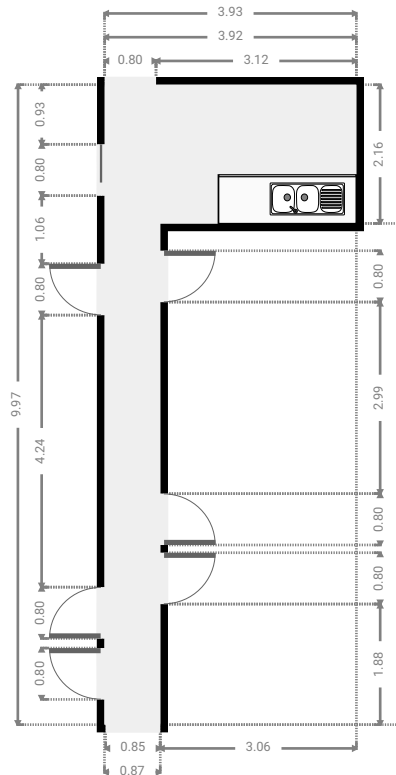
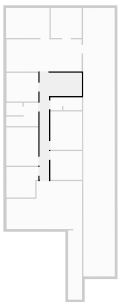

FLOORS: 1

▼ Bedroom  
Ground Floor

WIDTH: 2.98 m • LENGTH: 2.84 m  
AREA: 7.99 m<sup>2</sup> • PERIMETER: 11.65 m

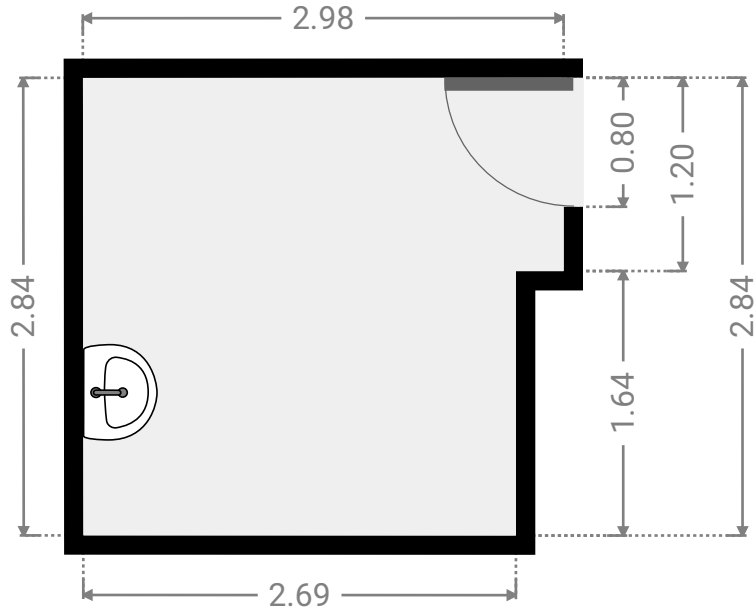
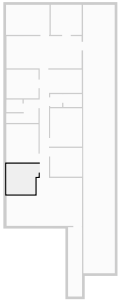

▼ Bedroom  
Ground Floor

WIDTH: 3.00 m • LENGTH: 3.57 m  
AREA: 10.71 m<sup>2</sup> • PERIMETER: 13.14 m

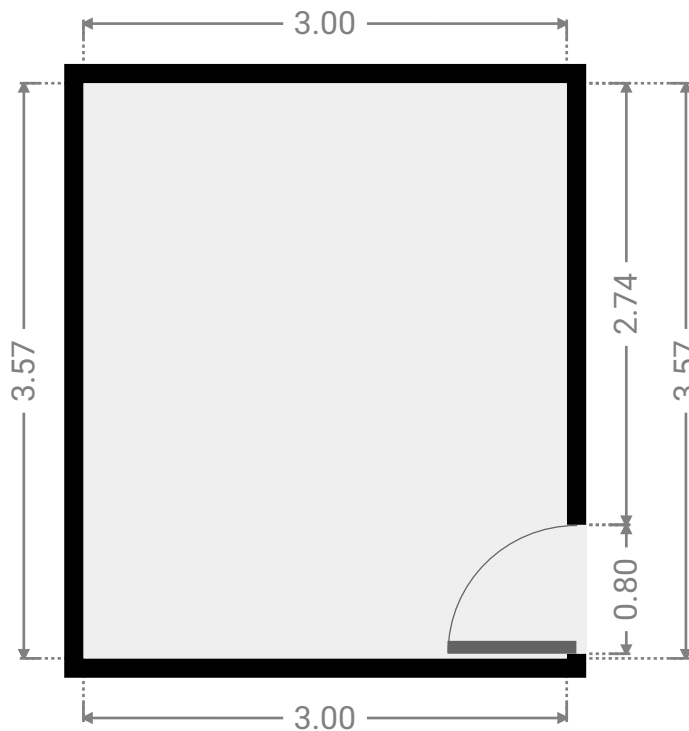
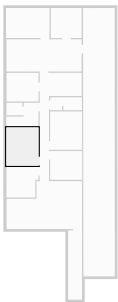

FLOORS: 1

▼ **Bedroom**  
Ground Floor

WIDTH: 2.98 m • LENGTH: 2.68 m  
AREA: 7.99 m<sup>2</sup> • PERIMETER: 11.32 m

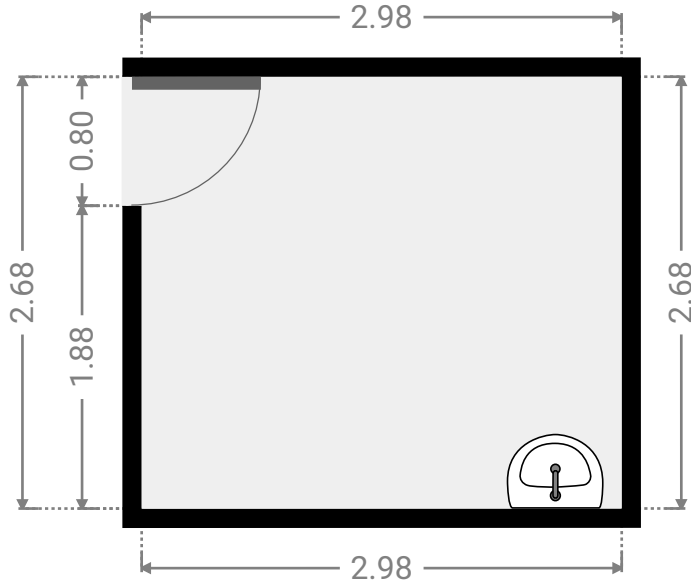
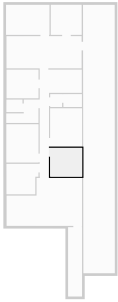

▼ **Bedroom**  
Ground Floor

WIDTH: 2.98 m • LENGTH: 3.57 m  
AREA: 10.64 m<sup>2</sup> • PERIMETER: 13.10 m

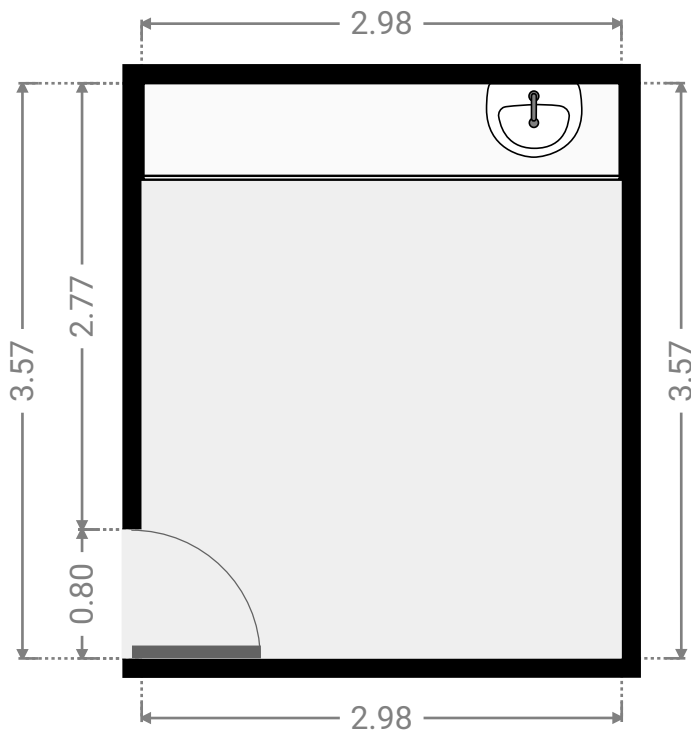
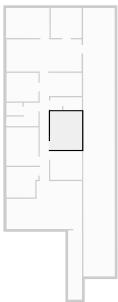

▼ Bathroom  
Ground Floor

WIDTH: 3.00 m • LENGTH: 2.18 m  
AREA: 4.44 m<sup>2</sup> • PERIMETER: 10.36 m

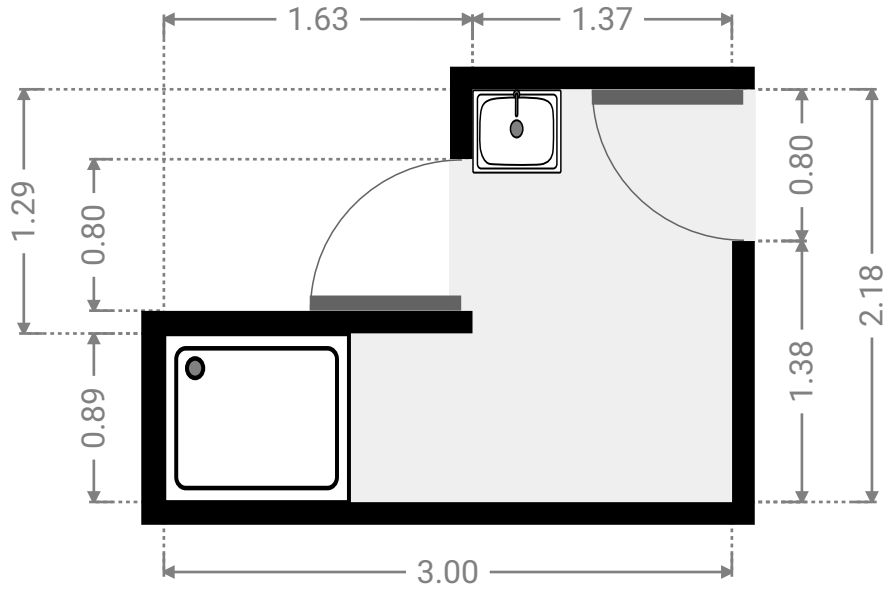
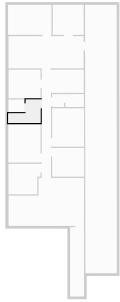

▼ Toilet  
Ground Floor

WIDTH: 1.50 m • LENGTH: 1.17 m  
AREA: 1.75 m<sup>2</sup> • PERIMETER: 5.34 m

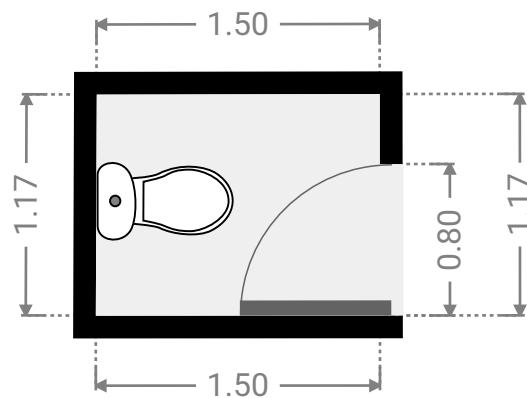
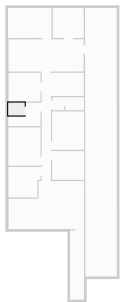

▼ **Hall**  
Ground Floor

WIDTH: 1.11 m • LENGTH: 1.20 m  
AREA: 1.33 m<sup>2</sup> • PERIMETER: 4.62 m

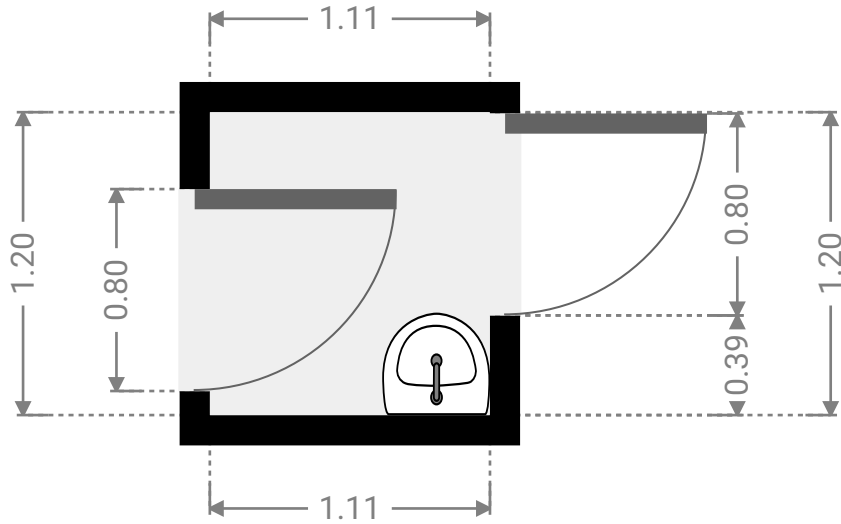
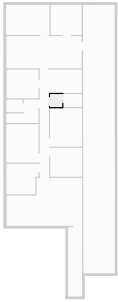

▼ **Toilet**  
Ground Floor

WIDTH: 1.72 m • LENGTH: 1.20 m  
AREA: 2.07 m<sup>2</sup> • PERIMETER: 5.85 m

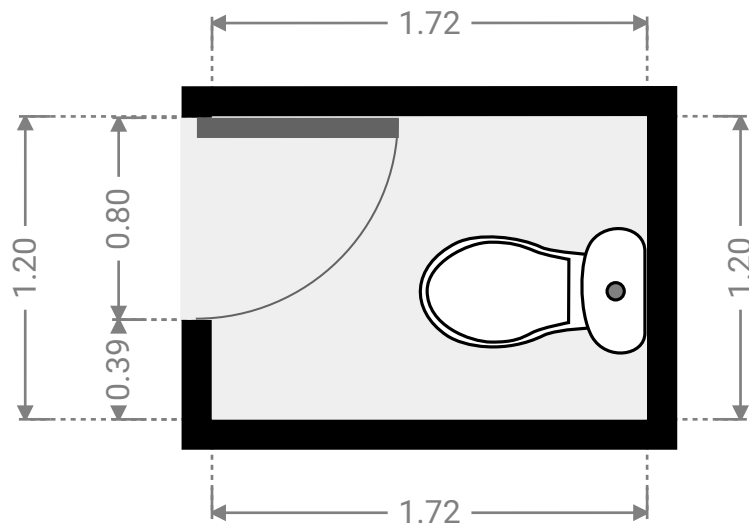
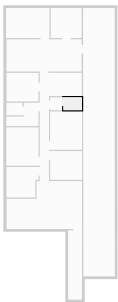

▼ **Bedroom**  
Ground Floor

WIDTH: 2.98 m • LENGTH: 2.67 m  
AREA: 7.96 m<sup>2</sup> • PERIMETER: 11.30 m

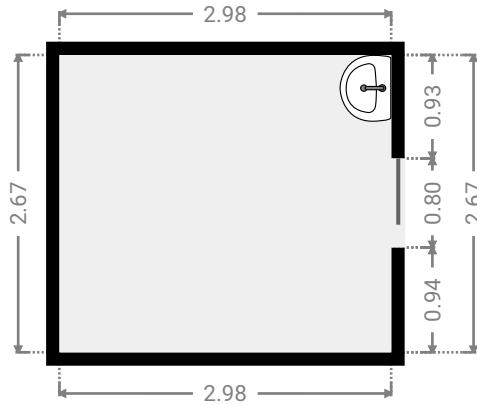
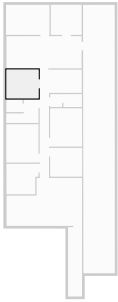

▼ **Kitchen**  
Ground Floor

WIDTH: 7.00 m • LENGTH: 3.00 m  
AREA: 21.00 m<sup>2</sup> • PERIMETER: 20.00 m

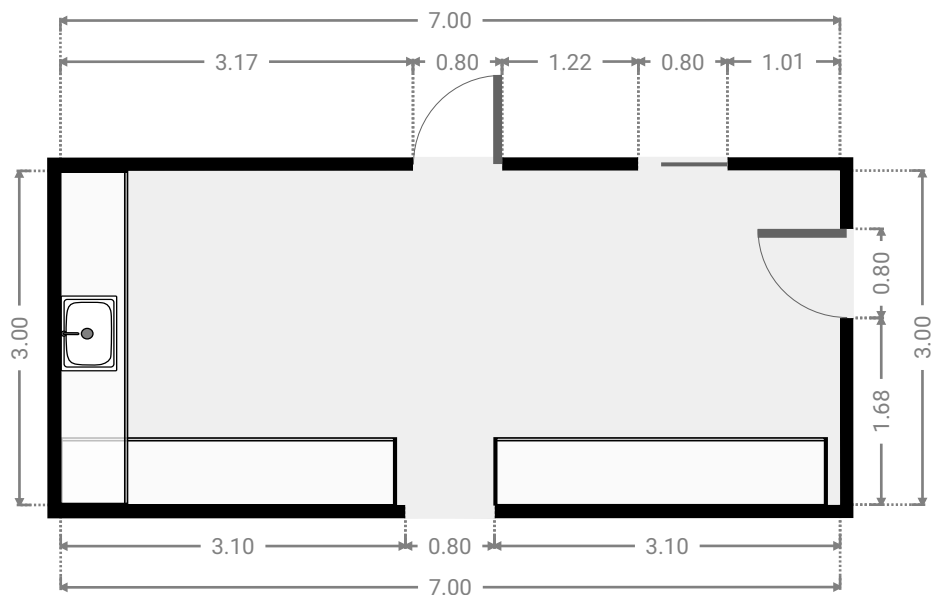
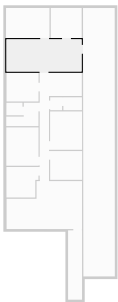



▼ **Bedroom**  
Ground Floor

WIDTH: 4.05 m • LENGTH: 2.80 m  
AREA: 11.34 m<sup>2</sup> • PERIMETER: 13.70 m

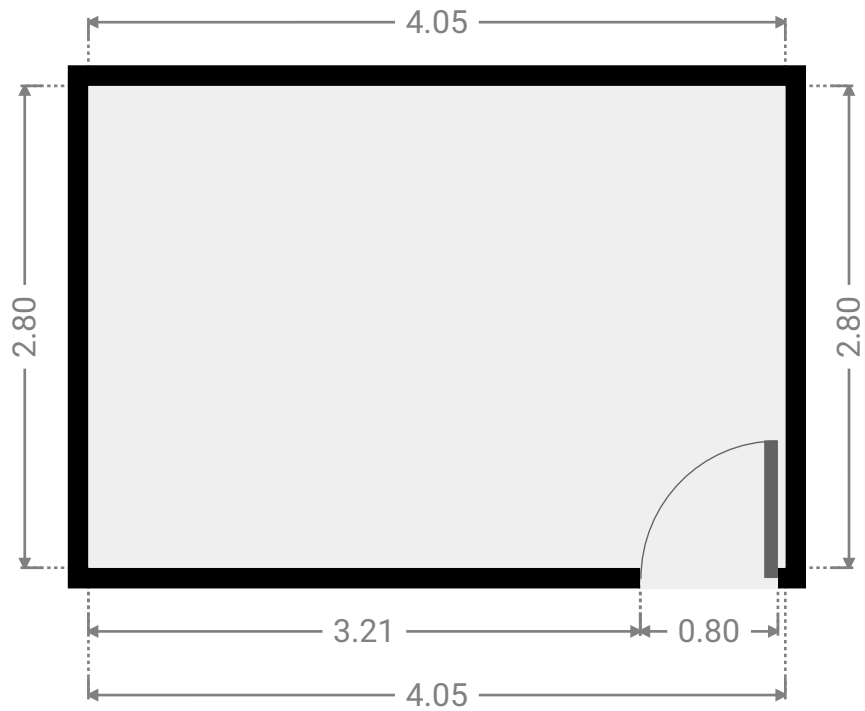
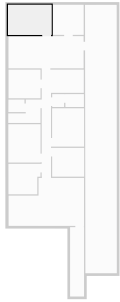

▼ **Study**  
Ground Floor

WIDTH: 2.88 m • LENGTH: 2.80 m  
AREA: 8.07 m<sup>2</sup> • PERIMETER: 11.36 m

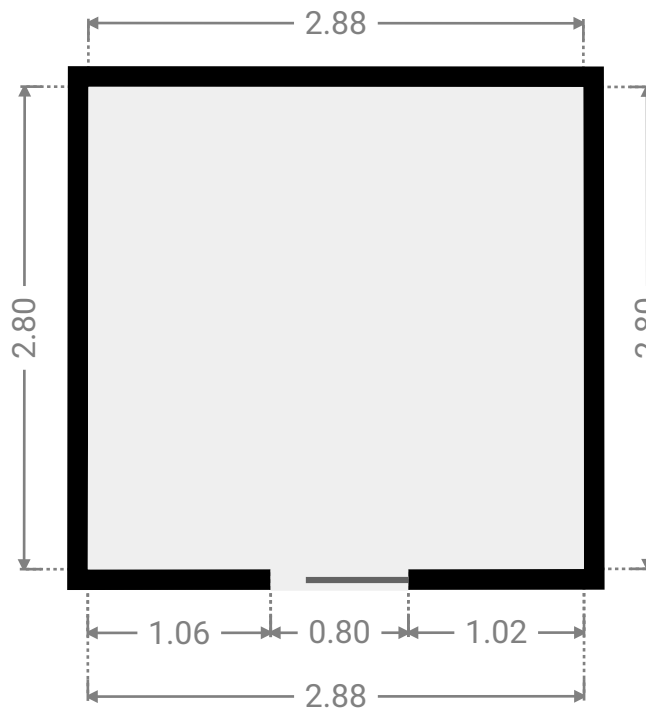
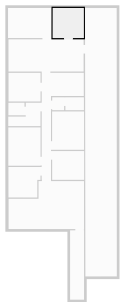

▼ **Hall**  
Ground Floor

WIDTH: 1.30 m • LENGTH: 6.46 m  
AREA: 8.40 m<sup>2</sup> • PERIMETER: 15.52 m

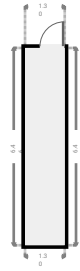
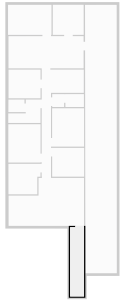

▼ **Garage**  
Ground Floor

WIDTH: 2.95 m • LENGTH: 25.01 m  
AREA: 73.50 m<sup>2</sup> • PERIMETER: 55.90 m

