

134 Earl Street

Ground Floor

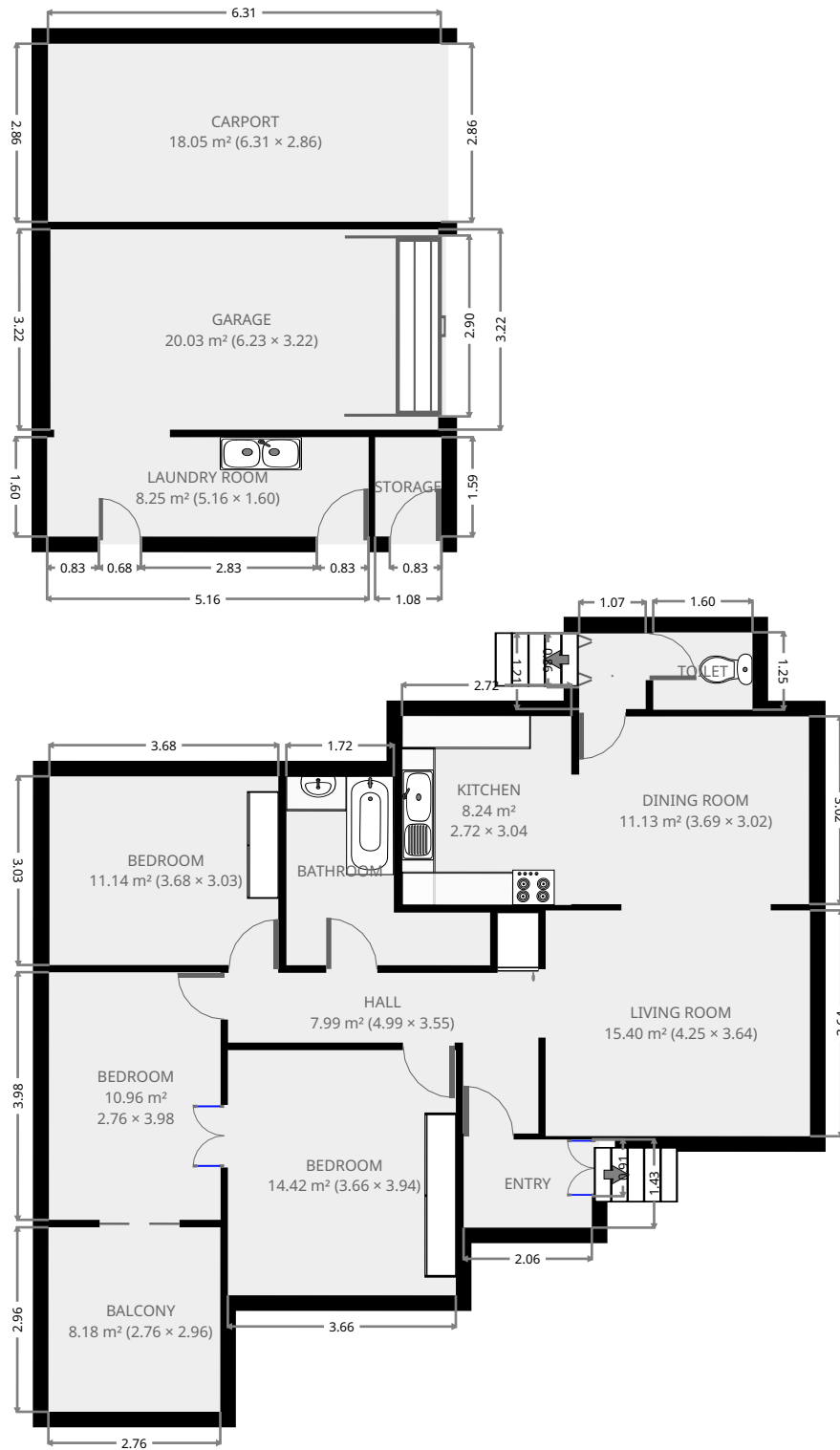

THIS FLOORPLAN IS PROVIDED WITHOUT WARRANTY OF ANY KIND. SENSOPIA DISCLAIMS ANY WARRANTY INCLUDING, WITHOUT LIMITATION, SATISFACTORY QUALITY OR ACCURACY OF DIMENSIONS.



134 Earl Street

Entry

Width: 1.43 m
 Length: 2.06 m
 Area: 2.92 m²
 Perimeter: 6.95 m

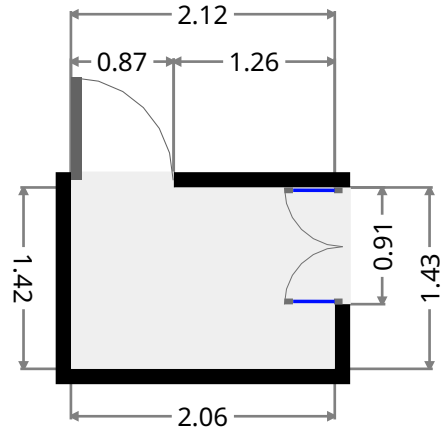
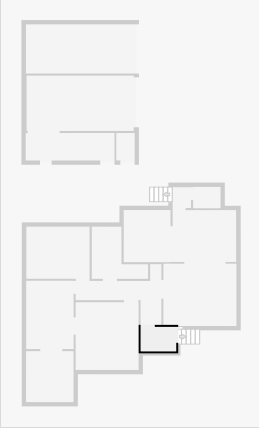

Hall

Width: 3.55 m
 Length: 4.99 m
 Area: 7.99 m²
 Perimeter: 17.08 m

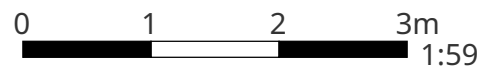
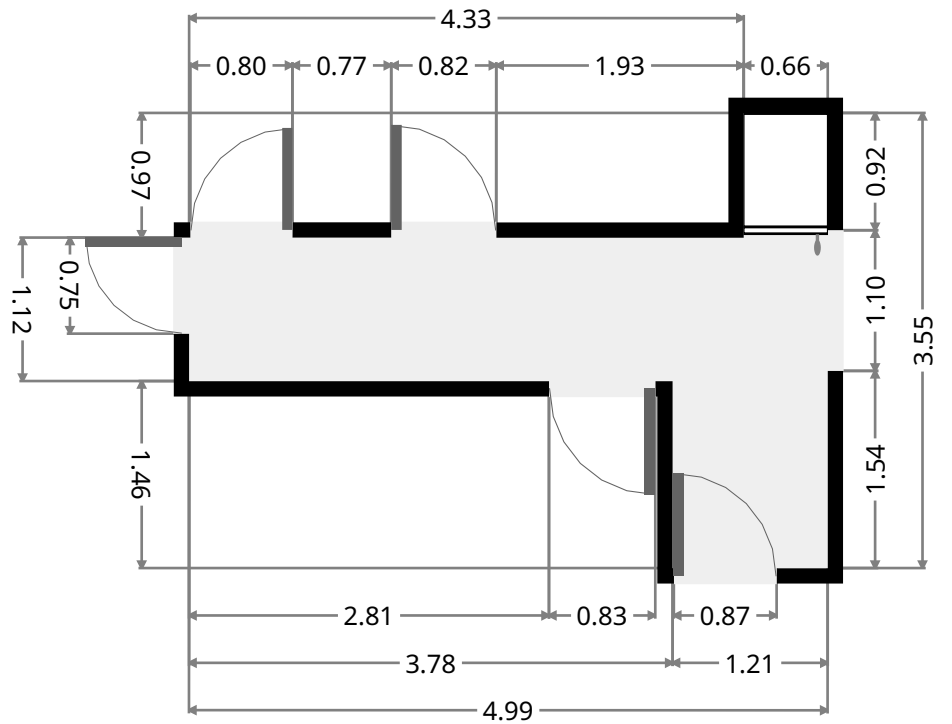
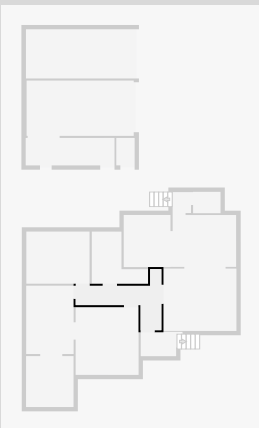

THIS FLOORPLAN IS PROVIDED WITHOUT WARRANTY OF ANY KIND. SENSOPIA DISCLAIMS ANY WARRANTY INCLUDING, WITHOUT LIMITATION, SATISFACTORY QUALITY OR ACCURACY OF DIMENSIONS.

134 Earl Street

Living Room

Width: 3.64 m
 Length: 4.25 m
 Area: 15.40 m²
 Perimeter: 15.75 m

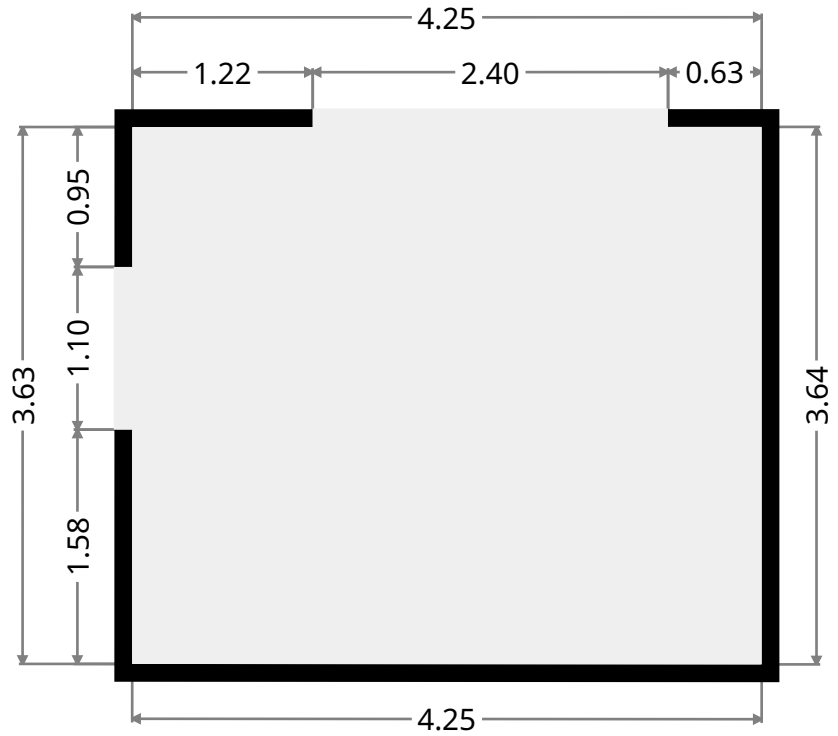
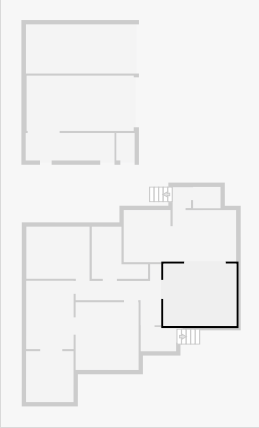

Bedroom

Width: 3.66 m
 Length: 3.94 m
 Area: 14.42 m²
 Perimeter: 15.20 m

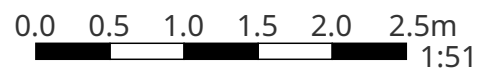
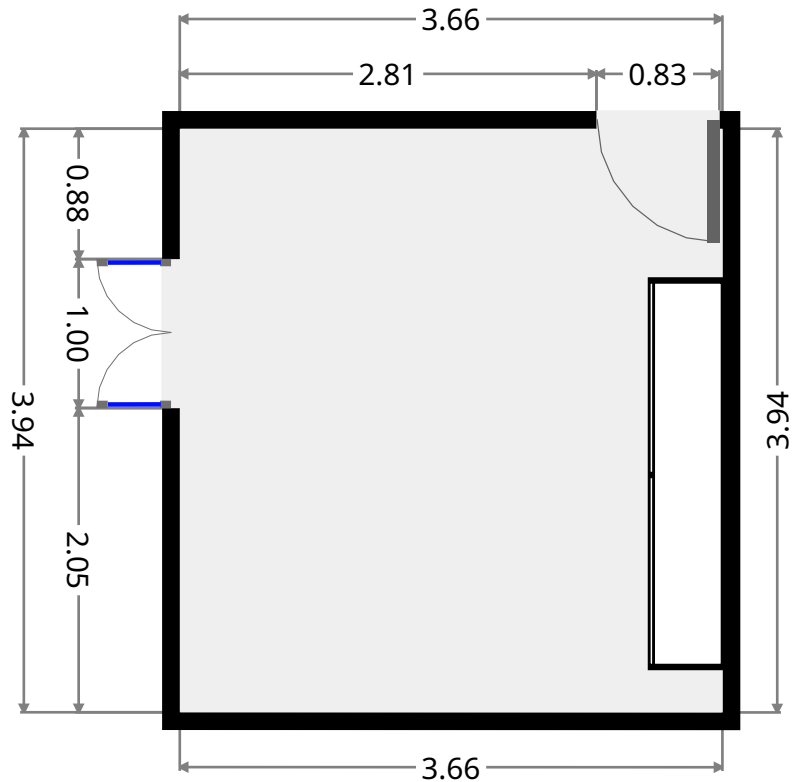
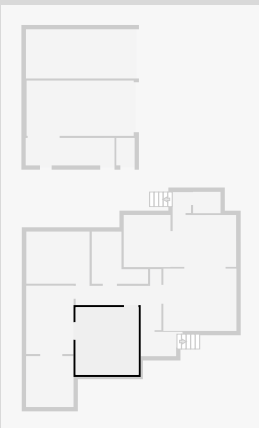

THIS FLOORPLAN IS PROVIDED WITHOUT WARRANTY OF ANY KIND. SENSOPIA DISCLAIMS ANY WARRANTY INCLUDING, WITHOUT LIMITATION, SATISFACTORY QUALITY OR ACCURACY OF DIMENSIONS.

134 Earl Street

Bedroom

Width: 2.76 m
Length: 3.98 m
Area: 10.96 m²
Perimeter: 13.47 m

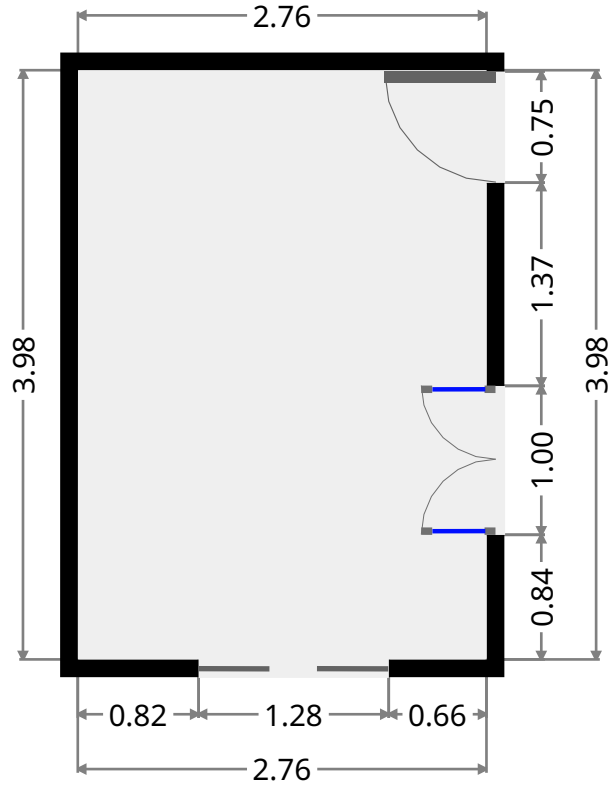
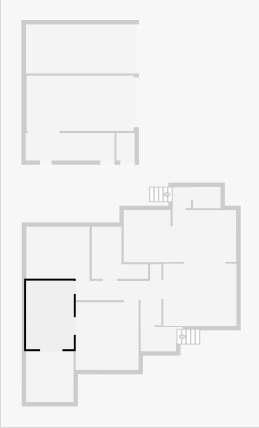

Balcony

Width: 2.76 m
Length: 2.96 m
Area: 8.18 m²
Perimeter: 11.45 m

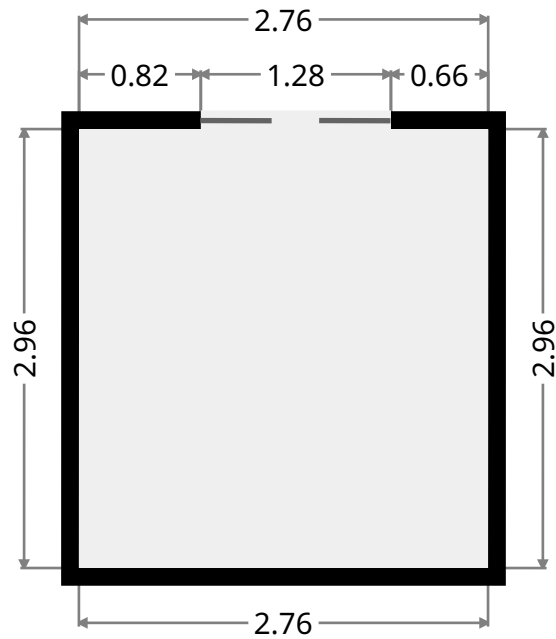
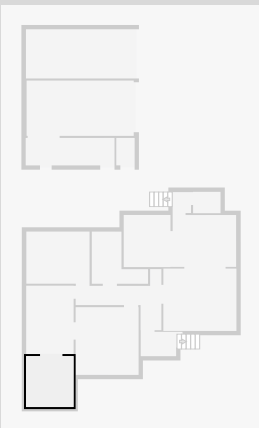

134 Earl Street

Bedroom

Width: 3.03 m
Length: 3.68 m
Area: 11.14 m²
Perimeter: 13.41 m

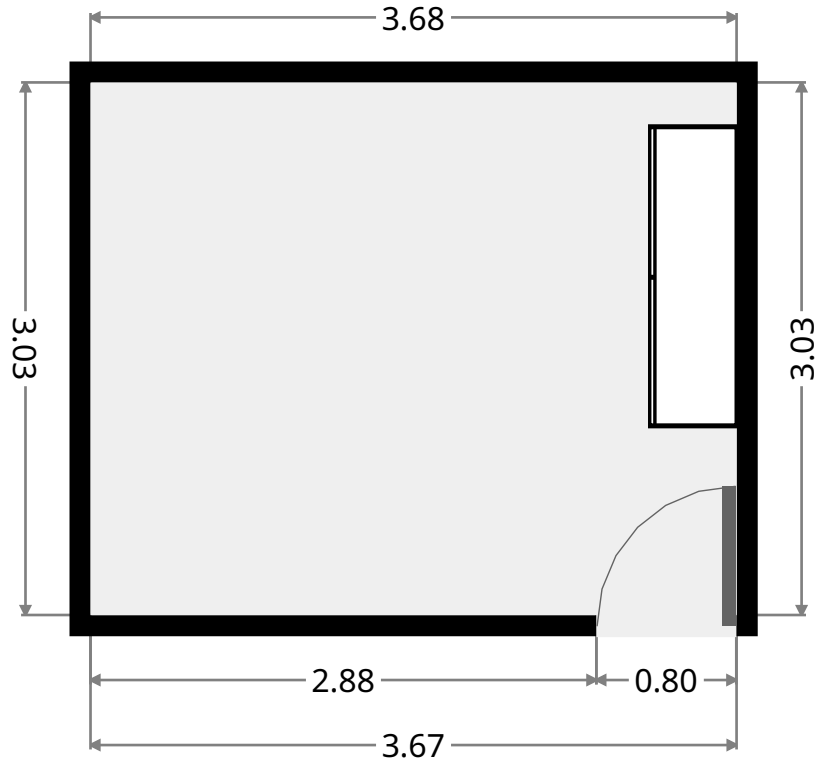
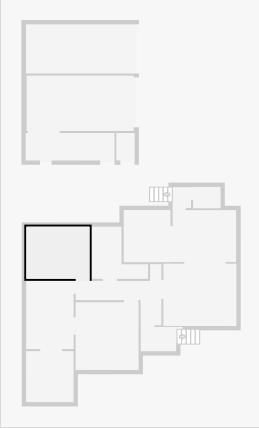

Bathroom

Width: 3.03 m
Length: 3.27 m
Area: 6.54 m²
Perimeter: 12.61 m

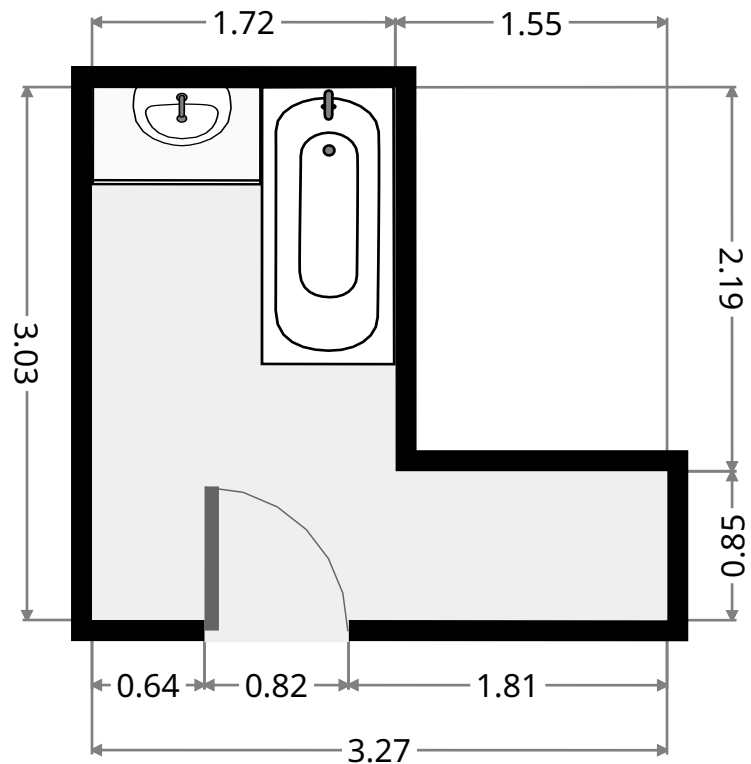
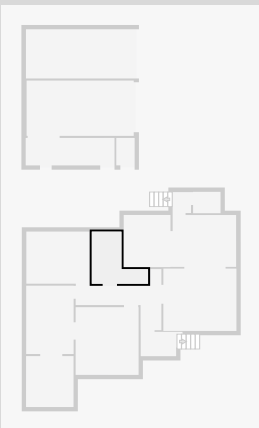

THIS FLOORPLAN IS PROVIDED WITHOUT WARRANTY OF ANY KIND. SENSOPIA DISCLAIMS ANY WARRANTY INCLUDING, WITHOUT LIMITATION, SATISFACTORY QUALITY OR ACCURACY OF DIMENSIONS.

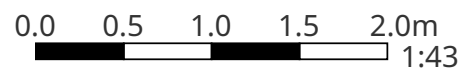

134 Earl Street

Dining Room

Width: 3.02 m
 Length: 3.69 m
 Area: 11.13 m²
 Perimeter: 13.41 m

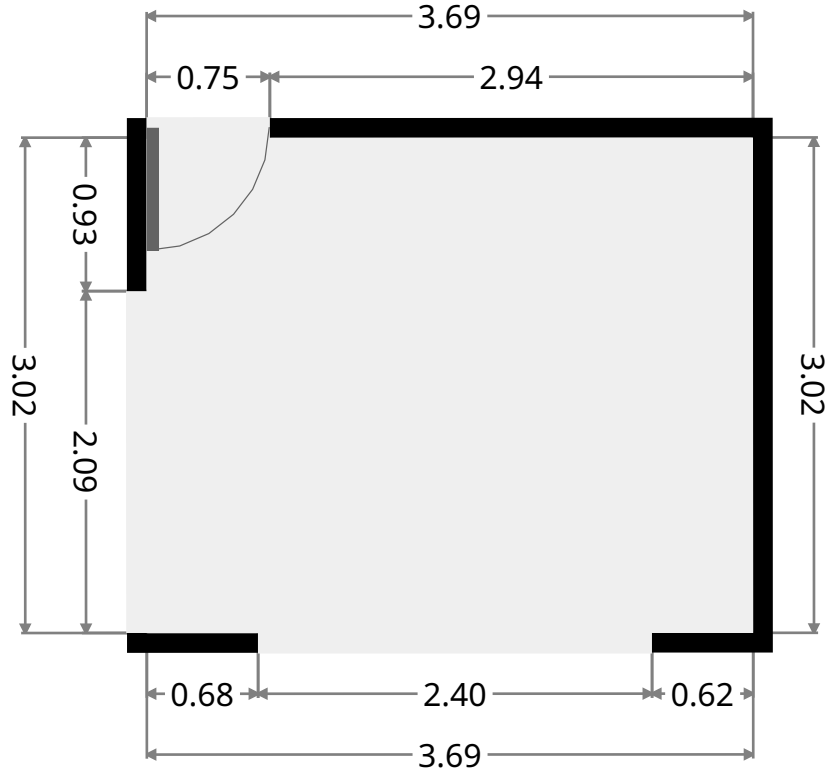
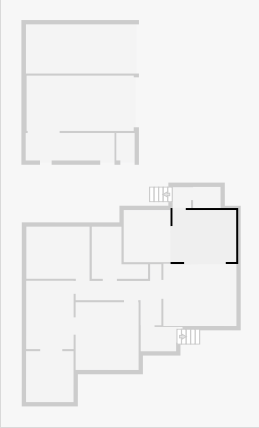

Kitchen

Width: 2.72 m
 Length: 3.04 m
 Area: 8.24 m²
 Perimeter: 11.50 m

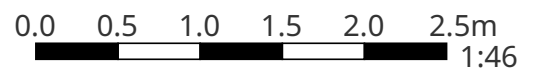
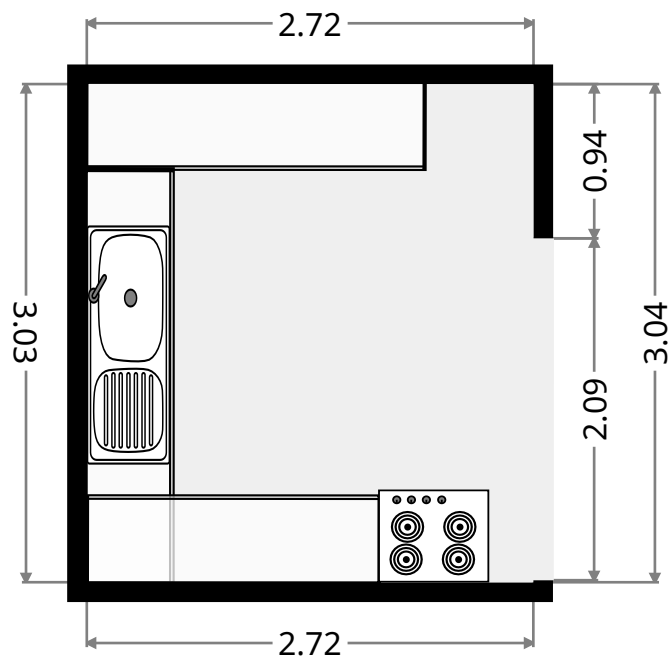
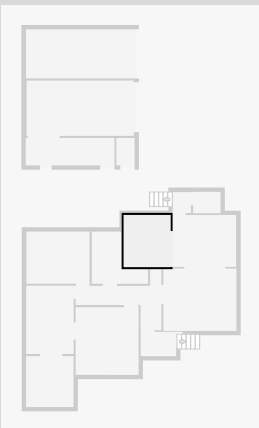

THIS FLOORPLAN IS PROVIDED WITHOUT WARRANTY OF ANY KIND. SENSOPIA DISCLAIMS ANY WARRANTY INCLUDING, WITHOUT LIMITATION, SATISFACTORY QUALITY OR ACCURACY OF DIMENSIONS.

134 Earl Street

•
 Width: 1.07 m
 Length: 1.21 m
 Area: 1.30 m²
 Perimeter: 4.56 m

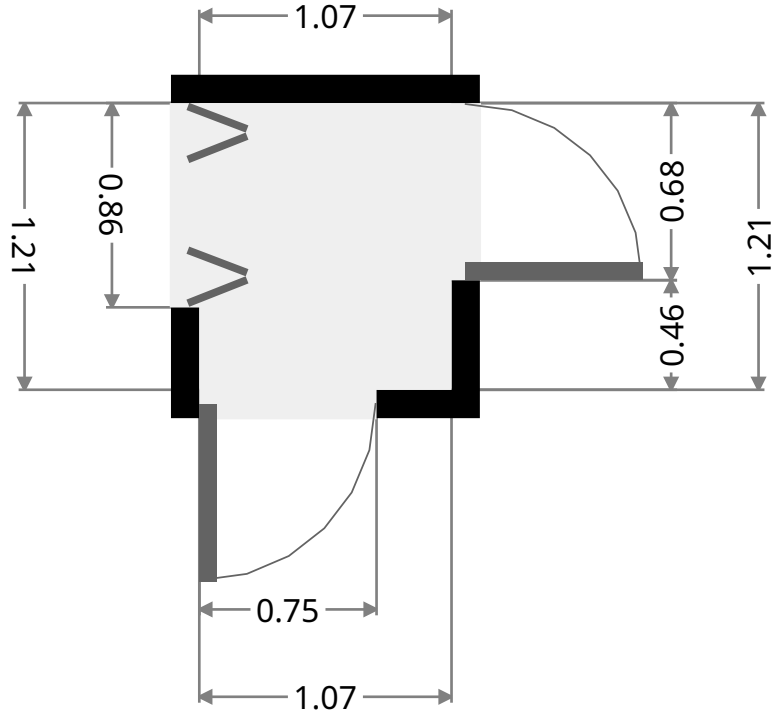
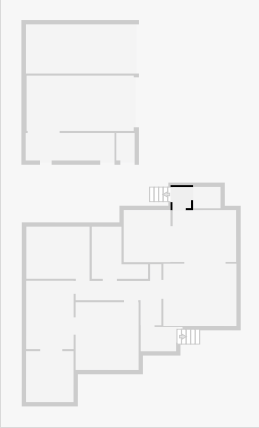

Toilet

Width: 1.25 m
 Length: 1.60 m
 Area: 1.98 m²
 Perimeter: 5.67 m

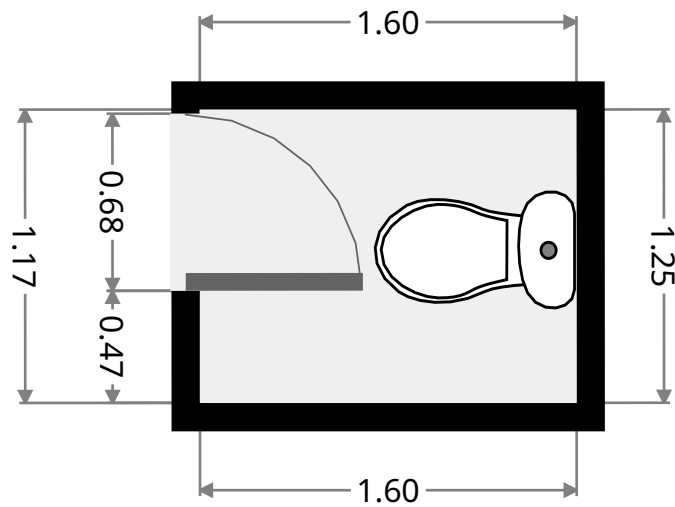
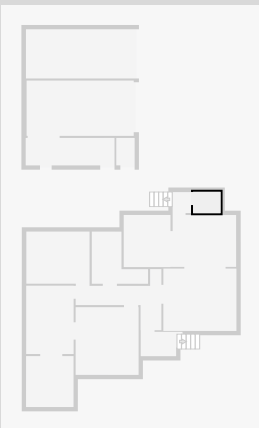

134 Earl Street

Laundry Room

Width: 1.60 m
Length: 5.16 m
Area: 8.25 m²
Perimeter: 13.52 m

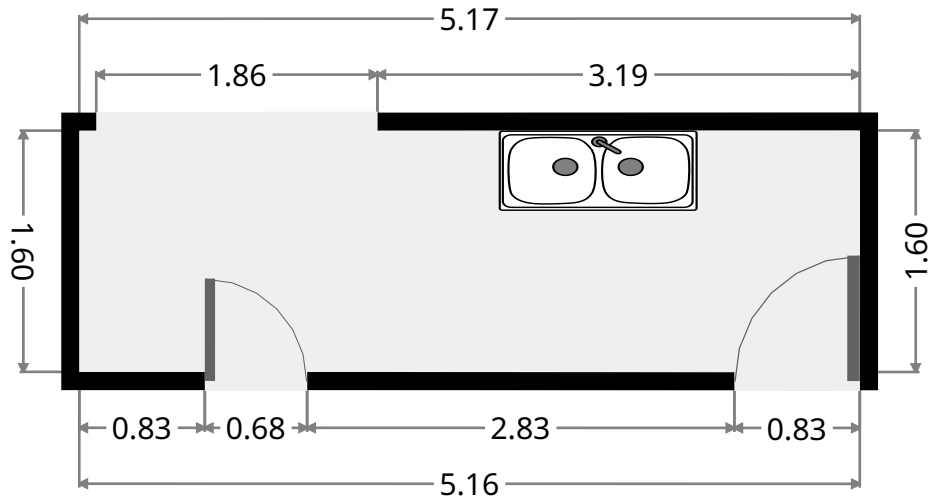
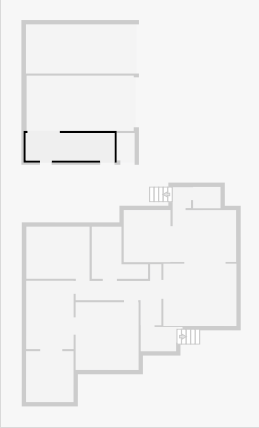

Storage

Width: 1.07 m
Length: 1.59 m
Area: 1.70 m²
Perimeter: 5.32 m

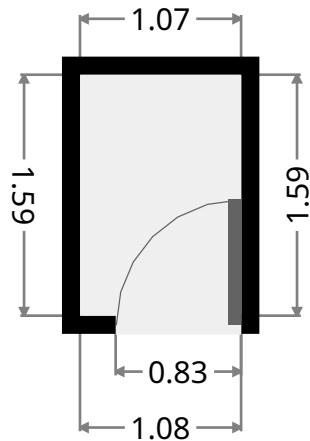
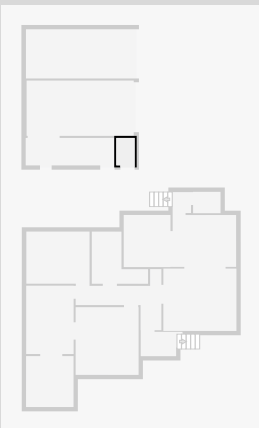

134 Earl Street

Garage

Width: 3.22 m
Length: 6.23 m
Area: 20.03 m²
Perimeter: 18.89 m

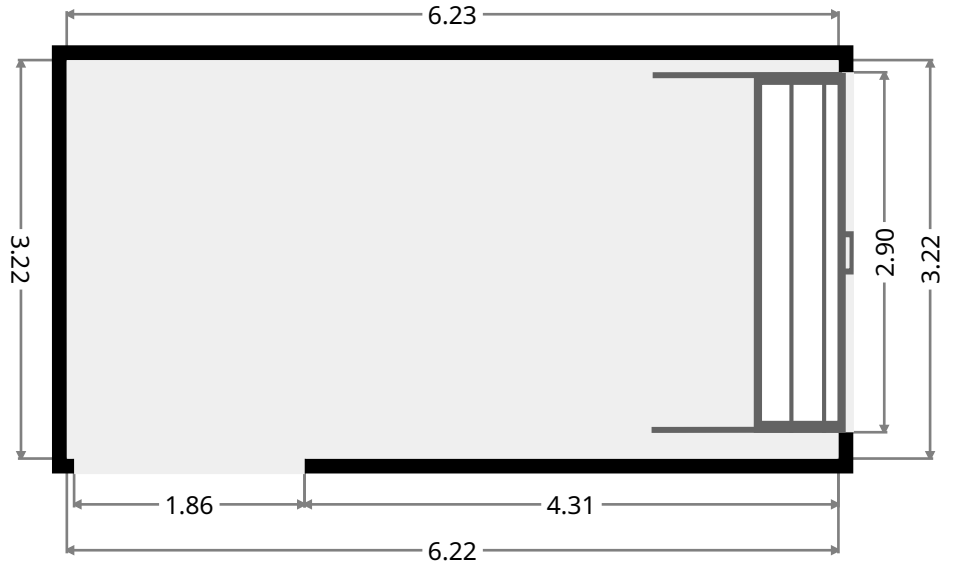
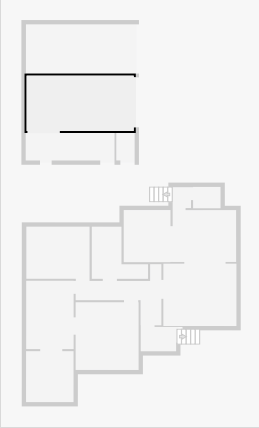

Carport

Width: 2.86 m
Length: 6.31 m
Area: 18.05 m²
Perimeter: 18.34 m

