

# 134 Constance Avenue

## Ground Floor



THIS FLOORPLAN IS PROVIDED WITHOUT WARRANTY OF ANY KIND. SENSOPIA DISCLAIMS ANY WARRANTY INCLUDING, WITHOUT LIMITATION, SATISFACTORY QUALITY OR ACCURACY OF DIMENSIONS.



# 134 Constance Avenue

## Kitchen/Living/Dining

Width: 6.88 m  
 Length: 11.48 m  
 Area: 62.51 m<sup>2</sup>  
 Perimeter: 36.72 m

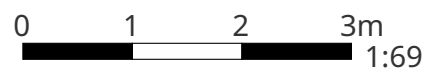
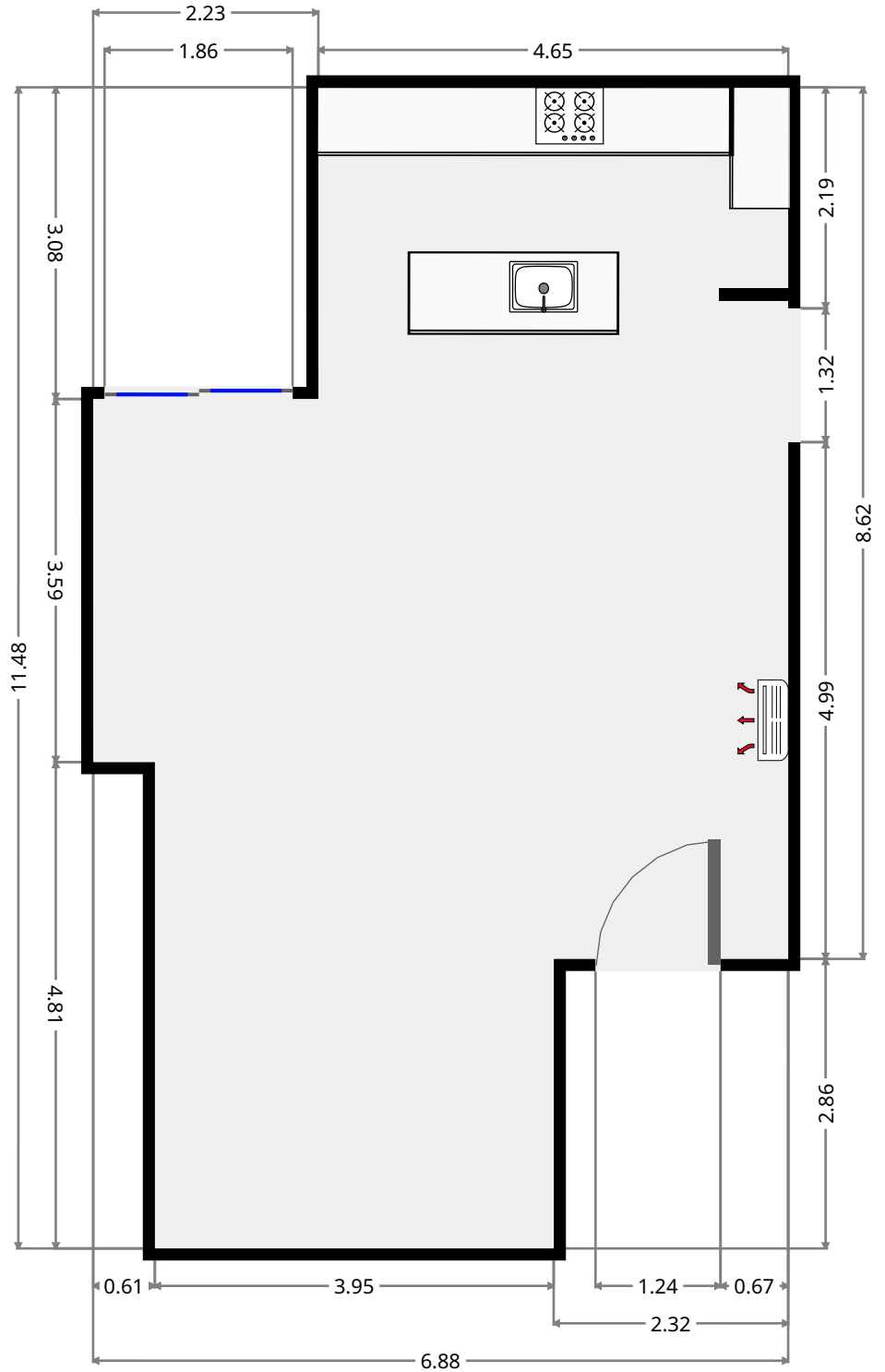
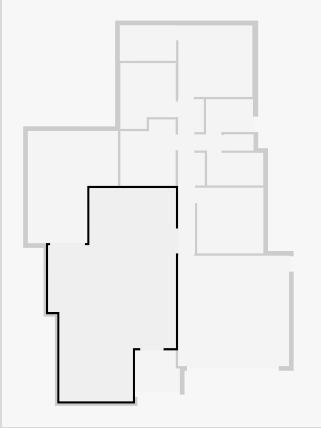

THIS FLOORPLAN IS PROVIDED WITHOUT WARRANTY OF ANY KIND. SENSOPIA DISCLAIMS ANY WARRANTY INCLUDING, WITHOUT LIMITATION, SATISFACTORY QUALITY OR ACCURACY OF DIMENSIONS.

# 134 Constance Avenue

## Hall

Width: 1.45 m  
 Length: 8.32 m  
 Area: 9.36 m<sup>2</sup>  
 Perimeter: 20.55 m

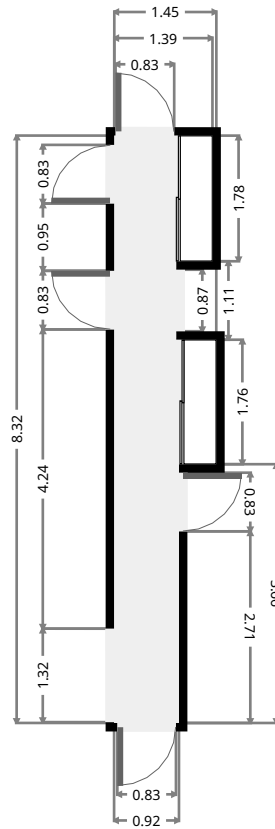
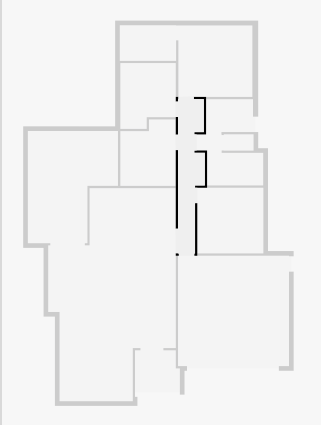

## Garage

Width: 5.95 m  
 Length: 5.98 m  
 Area: 35.58 m<sup>2</sup>  
 Perimeter: 23.86 m

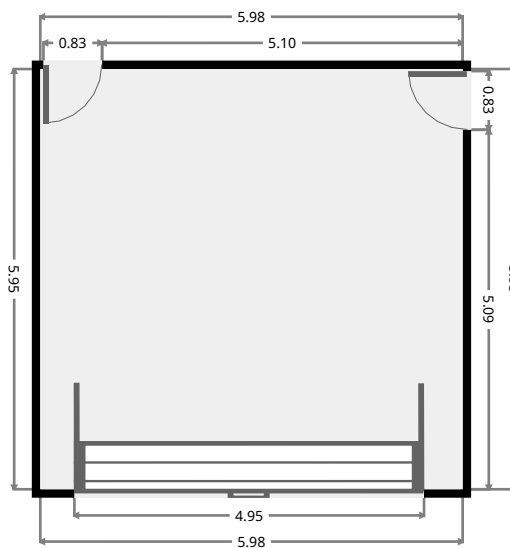
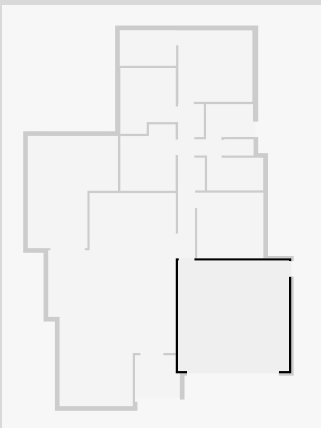

# 134 Constance Avenue

## Bedroom

Width: 3.54 m  
Length: 3.57 m  
Area: 12.64 m<sup>2</sup>  
Perimeter: 14.22 m

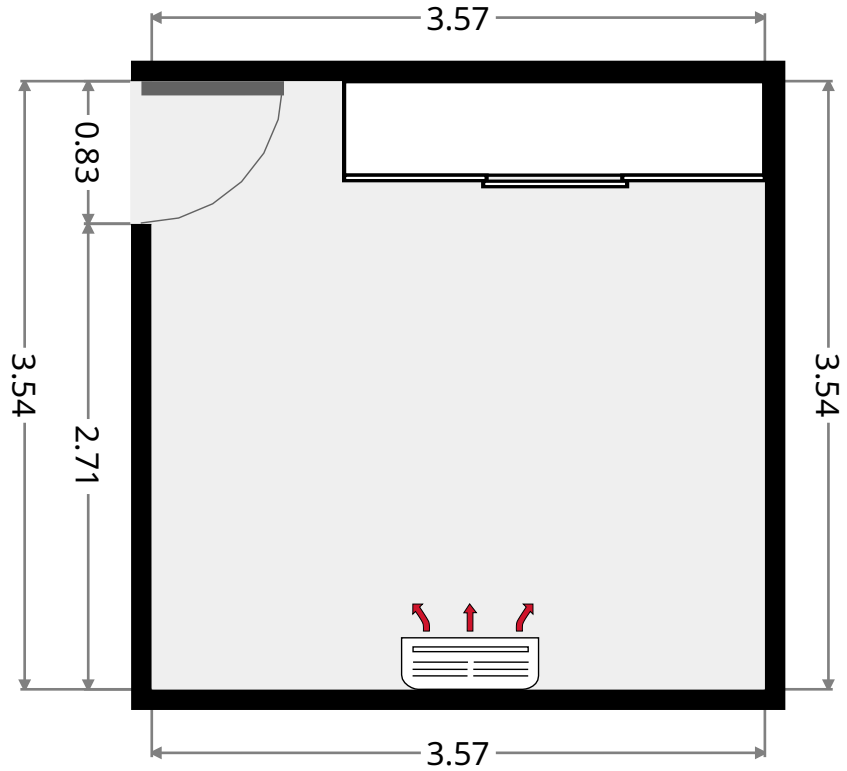
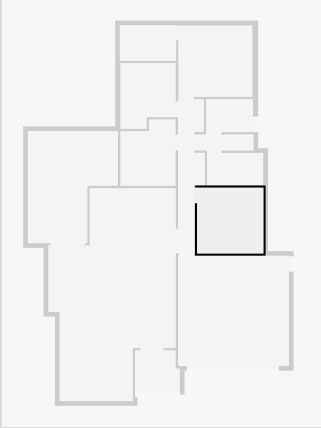

## Bathroom

Width: 1.75 m  
Length: 3.02 m  
Area: 5.31 m<sup>2</sup>  
Perimeter: 9.56 m

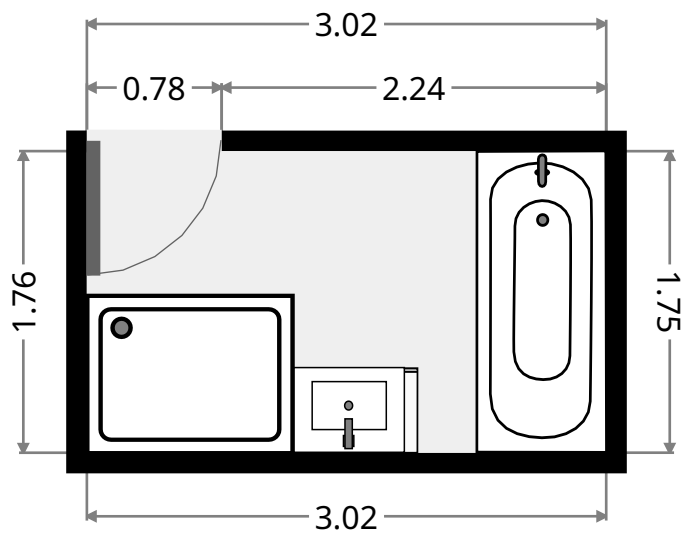
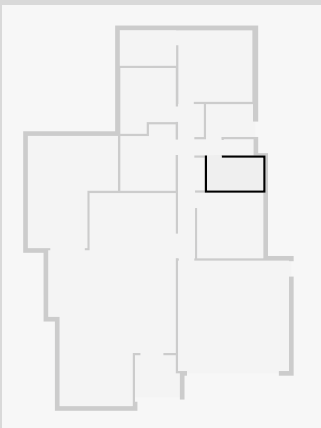

# 134 Constance Avenue

## Hall

Width: 0.87 m  
 Length: 1.36 m  
 Area: 1.18 m<sup>2</sup>  
 Perimeter: 4.46 m

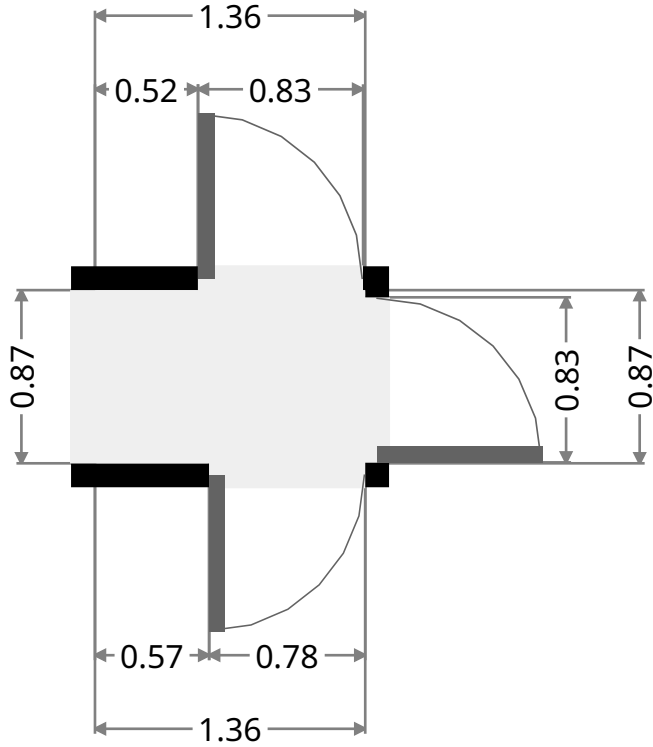
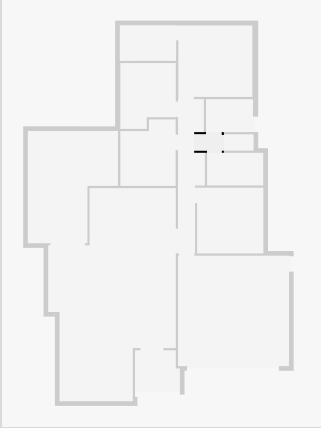

## Toilet

Width: 0.88 m  
 Length: 1.61 m  
 Area: 1.41 m<sup>2</sup>  
 Perimeter: 4.97 m

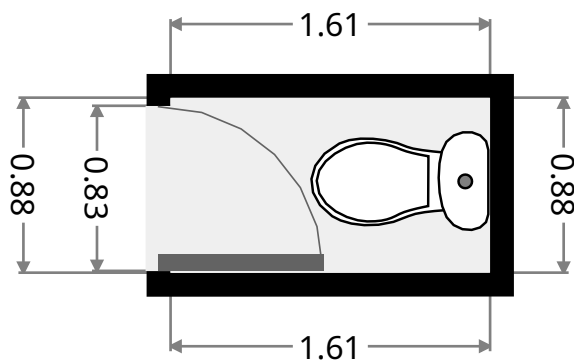
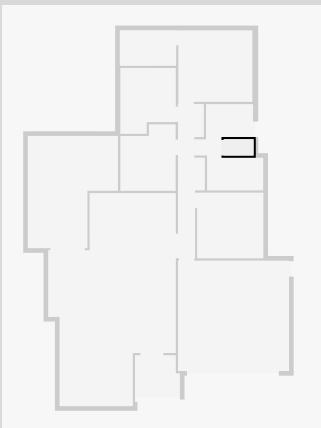

# 134 Constance Avenue

## Laundry Room

Width: 1.77 m  
Length: 2.53 m  
Area: 4.48 m<sup>2</sup>  
Perimeter: 8.60 m

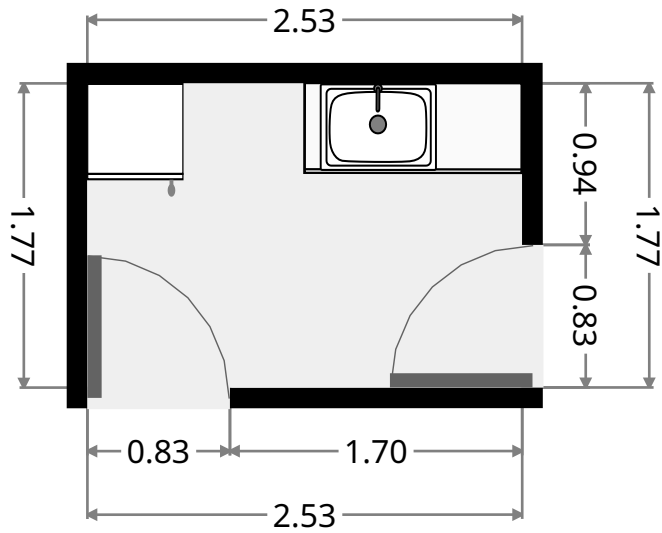
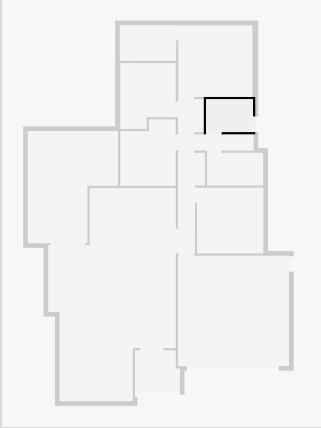

## Bedroom

Width: 2.98 m  
Length: 3.58 m  
Area: 9.70 m<sup>2</sup>  
Perimeter: 13.12 m

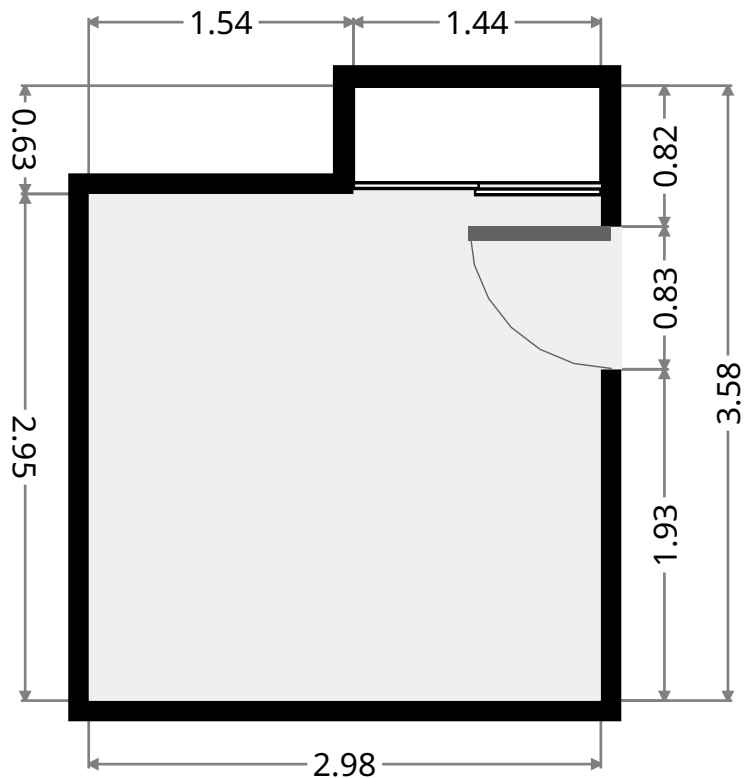
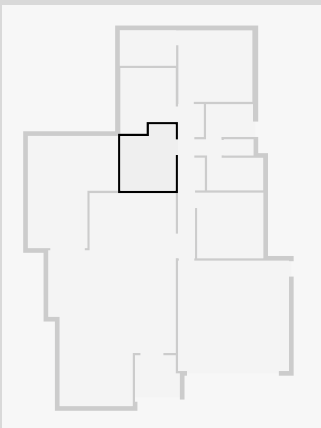

THIS FLOORPLAN IS PROVIDED WITHOUT WARRANTY OF ANY KIND. SENSOPIA DISCLAIMS ANY WARRANTY INCLUDING, WITHOUT LIMITATION, SATISFACTORY QUALITY OR ACCURACY OF DIMENSIONS.

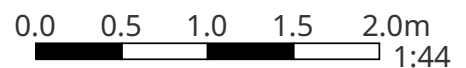

# 134 Constance Avenue

## Bedroom

Width: 2.98 m  
 Length: 3.55 m  
 Area: 9.61 m<sup>2</sup>  
 Perimeter: 13.07 m

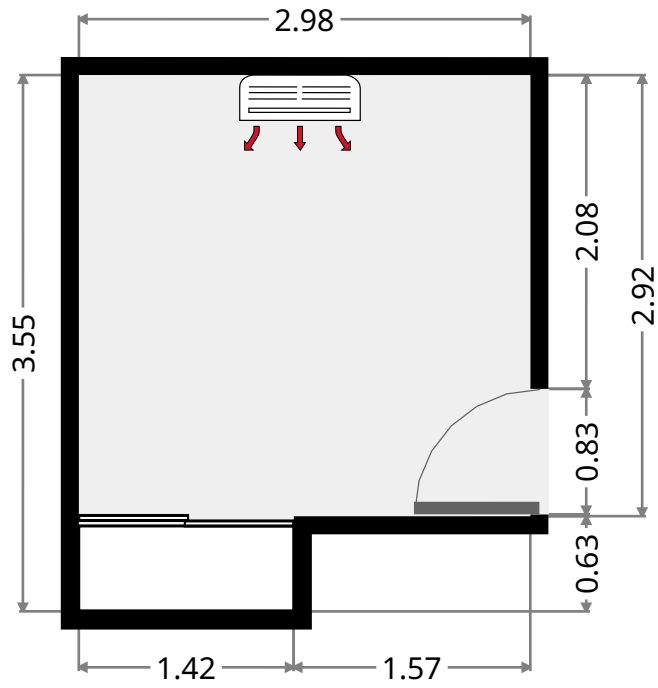
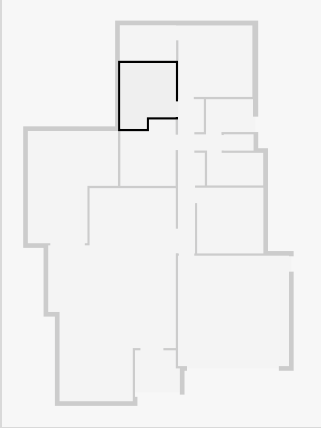

## Master Bedroom

Width: 3.85 m  
 Length: 3.99 m  
 Area: 15.35 m<sup>2</sup>  
 Perimeter: 15.68 m

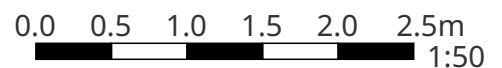
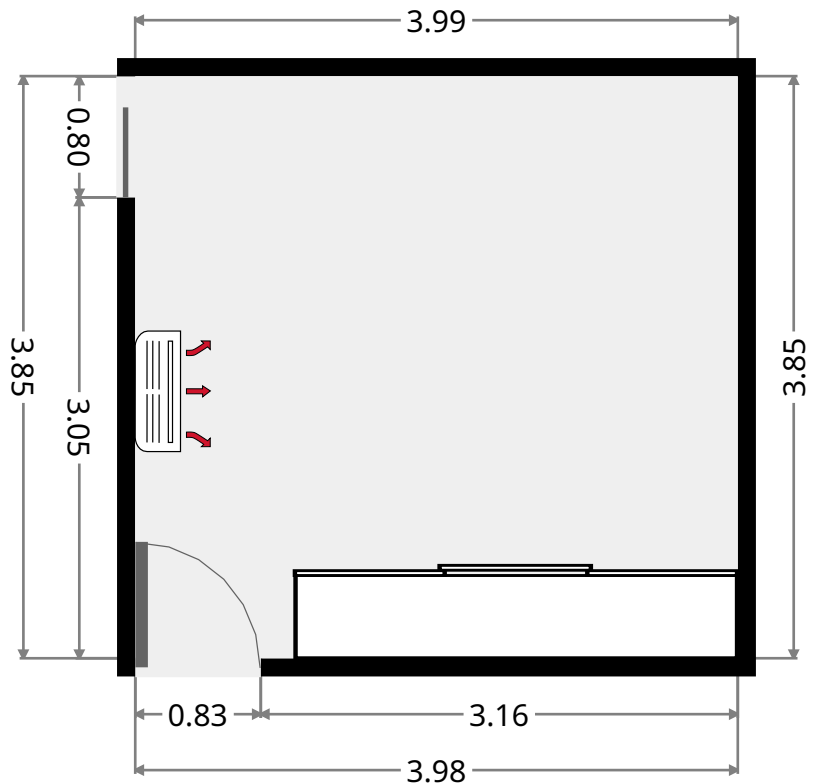
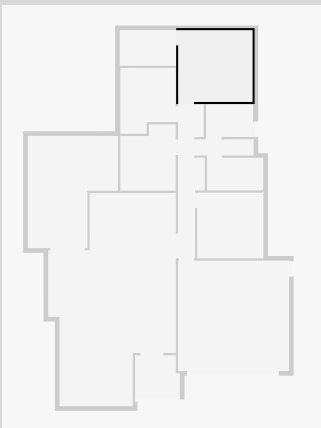

THIS FLOORPLAN IS PROVIDED WITHOUT WARRANTY OF ANY KIND. SENSOPIA DISCLAIMS ANY WARRANTY INCLUDING, WITHOUT LIMITATION, SATISFACTORY QUALITY OR ACCURACY OF DIMENSIONS.

# 134 Constance Avenue

## Ensuite

Width: 1.92 m  
Length: 3.04 m  
Area: 5.83 m<sup>2</sup>  
Perimeter: 9.91 m

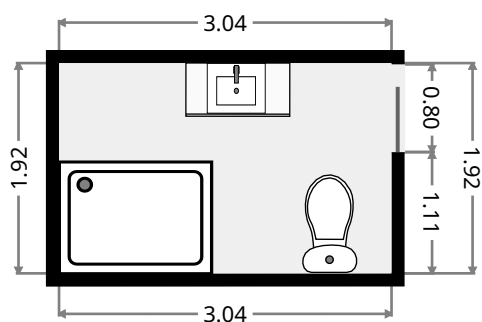
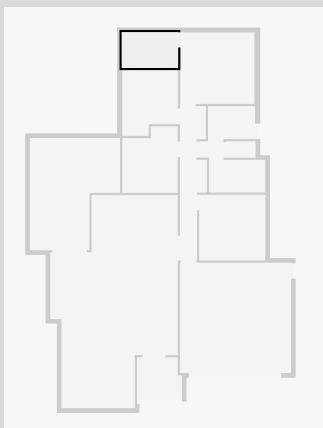

## Outdoor Area

Width: 4.86 m  
Length: 6.05 m  
Area: 24.28 m<sup>2</sup>  
Perimeter: 21.81 m

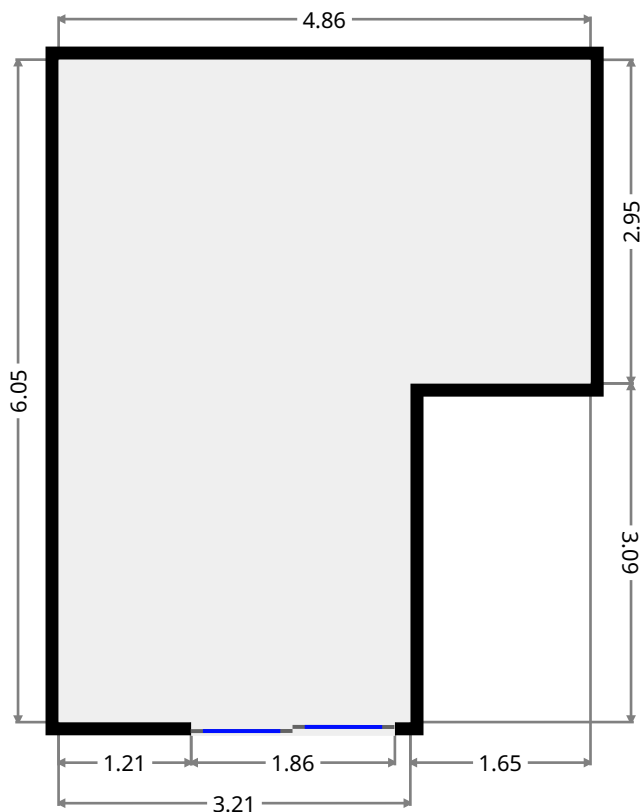
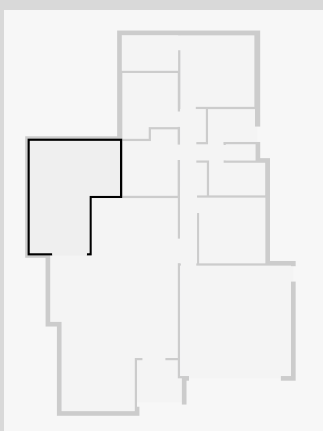



# 134 Constance Avenue

## Other

Width: 2.14 m  
Length: 2.42 m  
Area: 4.95 m<sup>2</sup>  
Perimeter: 9.11 m

