

# Ground Floor

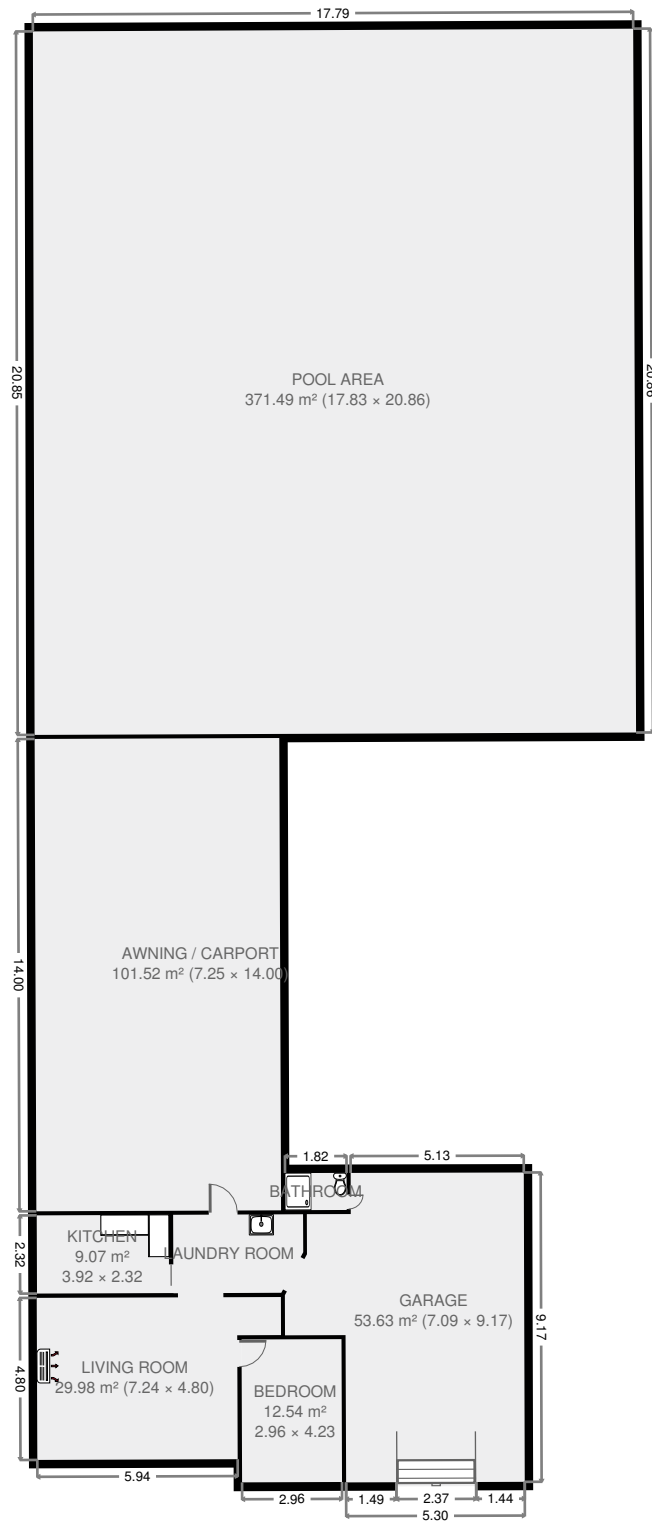

THIS FLOORPLAN IS PROVIDED WITHOUT WARRANTY OF ANY KIND. SENSOPIA DISCLAIMS ANY WARRANTY INCLUDING, WITHOUT LIMITATION, SATISFACTORY QUALITY OR ACCURACY OF DIMENSIONS.

## 134 Alexandra Street

# Living Room

Width: 4.80 m  
Length: 7.24 m  
Area: 29.98 m<sup>2</sup>  
Perimeter: 24.08 m

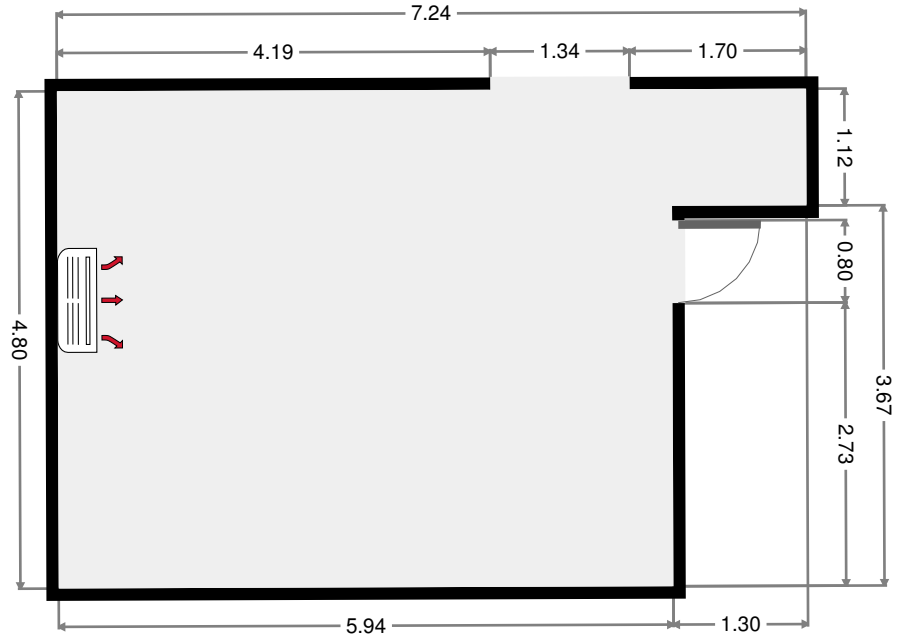

# Bedroom

Width: 2.96 m  
Length: 4.23 m  
Area: 12.54 m<sup>2</sup>  
Perimeter: 14.39 m

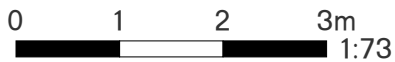
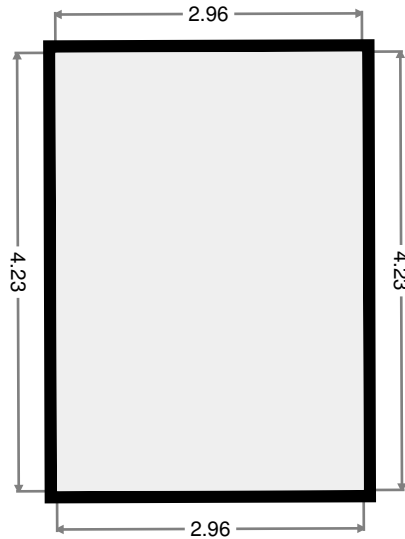
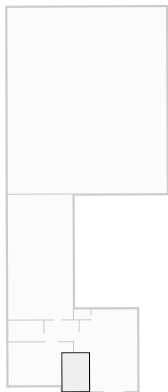

THIS FLOORPLAN IS PROVIDED WITHOUT WARRANTY OF ANY KIND. SENSOPIA DISCLAIMS ANY WARRANTY INCLUDING, WITHOUT LIMITATION, SATISFACTORY QUALITY OR ACCURACY OF DIMENSIONS.

# Laundry Room

Width: 2.32 m  
 Length: 3.85 m  
 Area: 8.56 m<sup>2</sup>  
 Perimeter: 11.86 m  
 Ceiling Height: 2.17 m

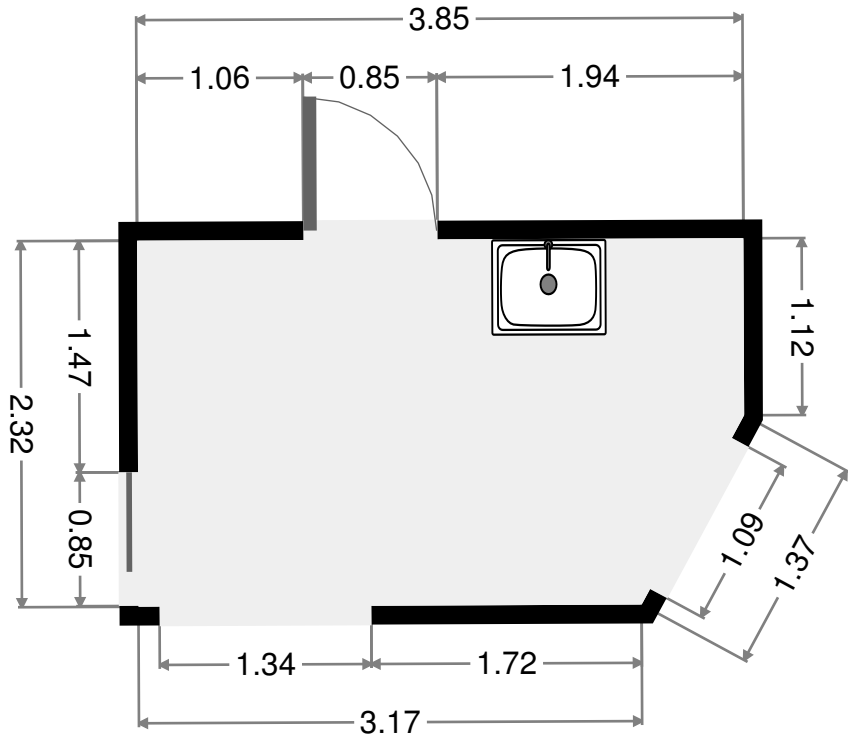

# Kitchen

Width: 2.32 m  
 Length: 3.92 m  
 Area: 9.07 m<sup>2</sup>  
 Perimeter: 12.46 m

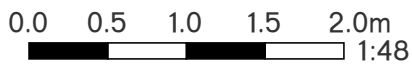
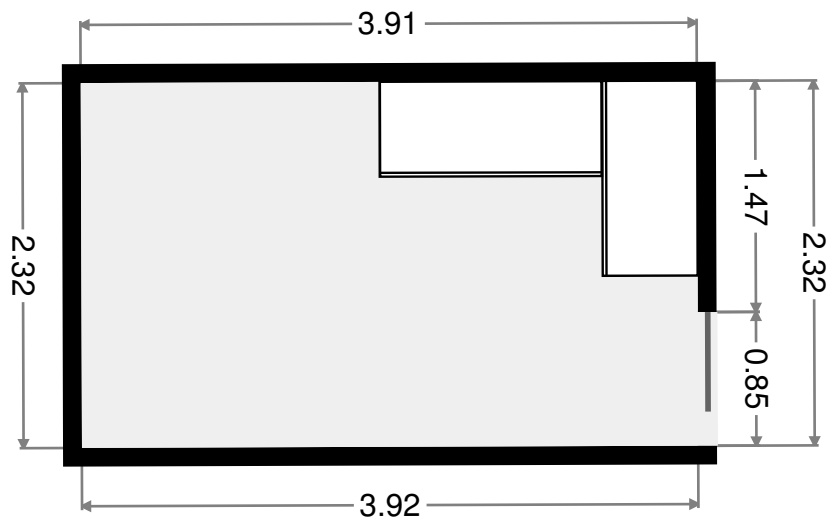

THIS FLOORPLAN IS PROVIDED WITHOUT WARRANTY OF ANY KIND. SENSOPIA DISCLAIMS ANY WARRANTY INCLUDING, WITHOUT LIMITATION, SATISFACTORY QUALITY OR ACCURACY OF DIMENSIONS.

# Garage

Width: 7.09 m  
 Length: 9.17 m  
 Area: 53.63 m<sup>2</sup>  
 Perimeter: 32.03 m  
 Ceiling Height: 2.17 m

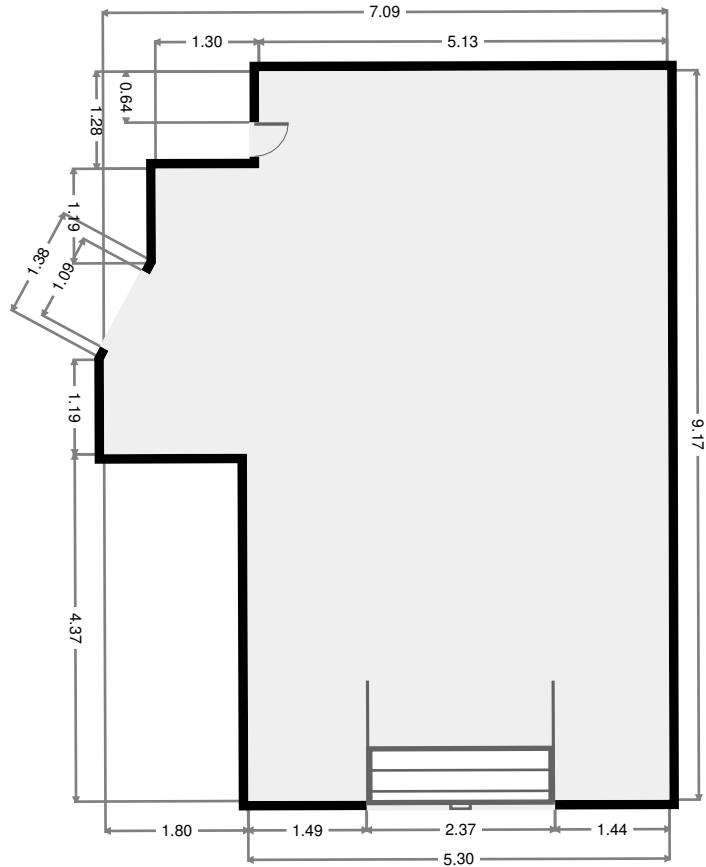

# Bathroom

Width: 1.10 m  
 Length: 1.82 m  
 Area: 2.00 m<sup>2</sup>  
 Perimeter: 5.85 m

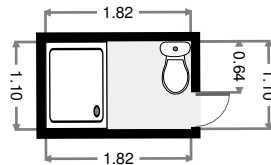

THIS FLOORPLAN IS PROVIDED WITHOUT WARRANTY OF ANY KIND. SENSOPIA DISCLAIMS ANY WARRANTY INCLUDING, WITHOUT LIMITATION, SATISFACTORY QUALITY OR ACCURACY OF DIMENSIONS.

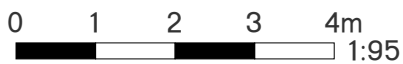

# Awning / Carport

Width: 7.25 m  
Length: 14.00 m  
Area: 101.52 m<sup>2</sup>  
Perimeter: 42.50 m

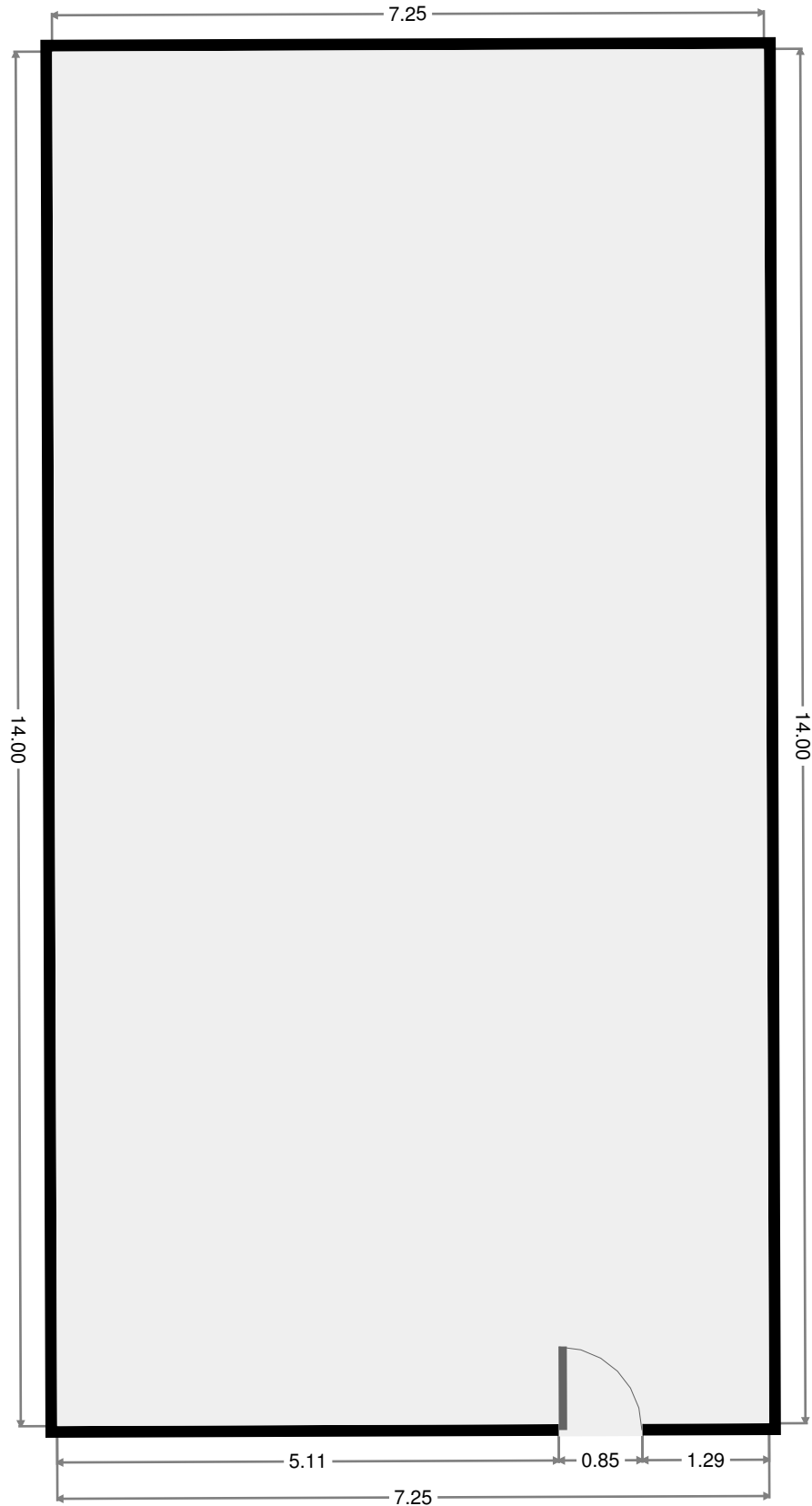
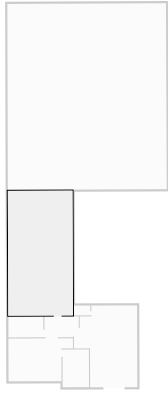

THIS FLOORPLAN IS PROVIDED WITHOUT WARRANTY OF ANY KIND. SENSOPIA DISCLAIMS ANY WARRANTY INCLUDING, WITHOUT LIMITATION, SATISFACTORY QUALITY OR ACCURACY OF DIMENSIONS.

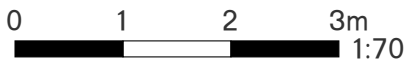

134 Alexandra Street

2017-02-23

# Pool Area

Width: 17.83 m  
Length: 20.86 m  
Area: 371.49 m<sup>2</sup>  
Perimeter: 77.34 m  
Ceiling Height: 2.17 m

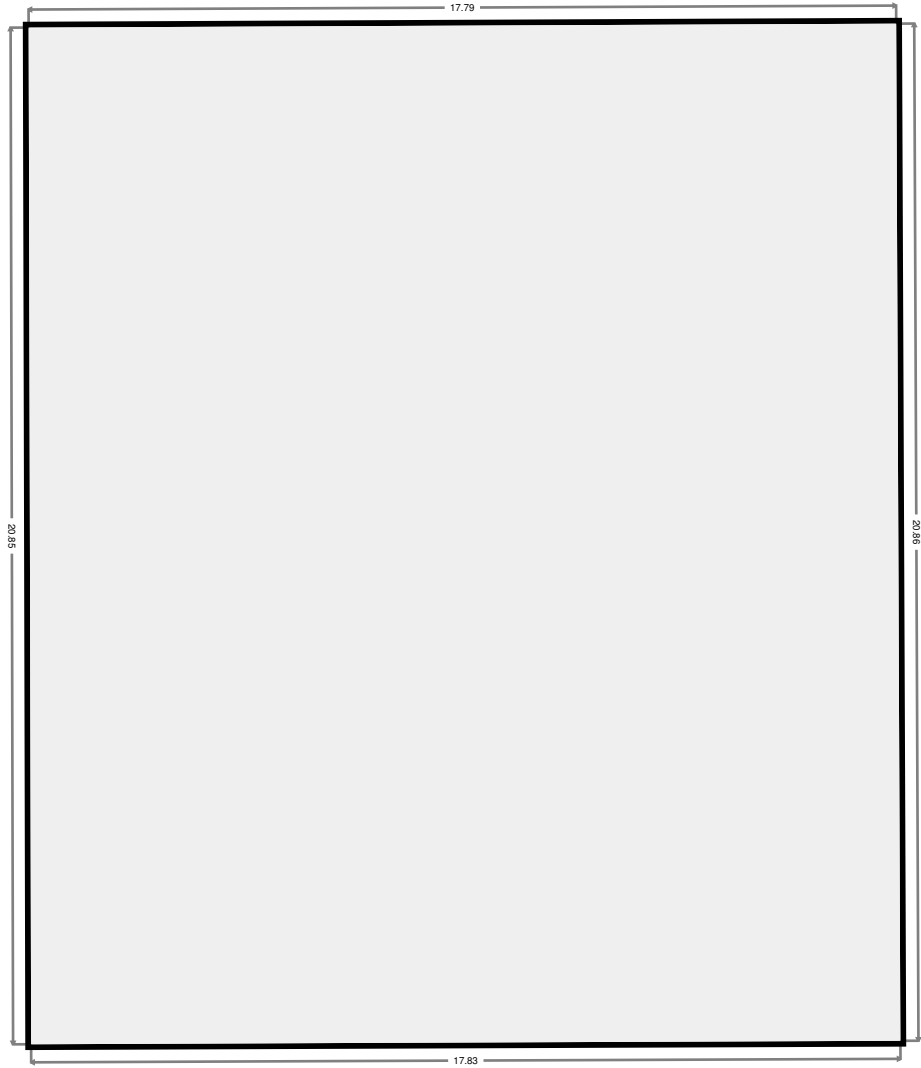

THIS FLOORPLAN IS PROVIDED WITHOUT WARRANTY OF ANY KIND. SENSOPIA DISCLAIMS ANY WARRANTY INCLUDING, WITHOUT LIMITATION, SATISFACTORY QUALITY OR ACCURACY OF DIMENSIONS.



# 1st Floor

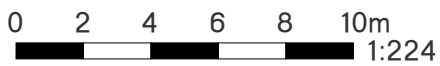
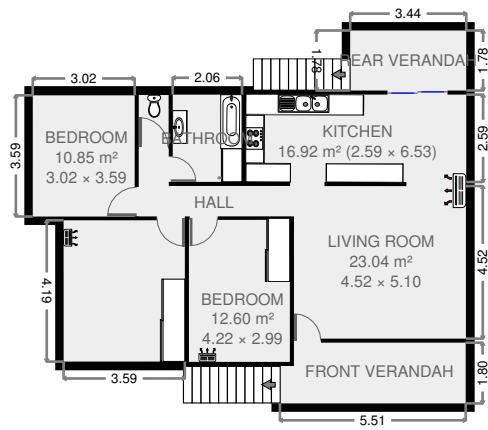

134 Alexandra Street

THIS FLOORPLAN IS PROVIDED WITHOUT WARRANTY OF ANY KIND. SENSOPIA DISCLAIMS ANY WARRANTY INCLUDING, WITHOUT LIMITATION, SATISFACTORY QUALITY OR ACCURACY OF DIMENSIONS.

# Kitchen

Width: 2.59 m  
 Length: 6.53 m  
 Area: 16.92 m<sup>2</sup>  
 Perimeter: 18.24 m

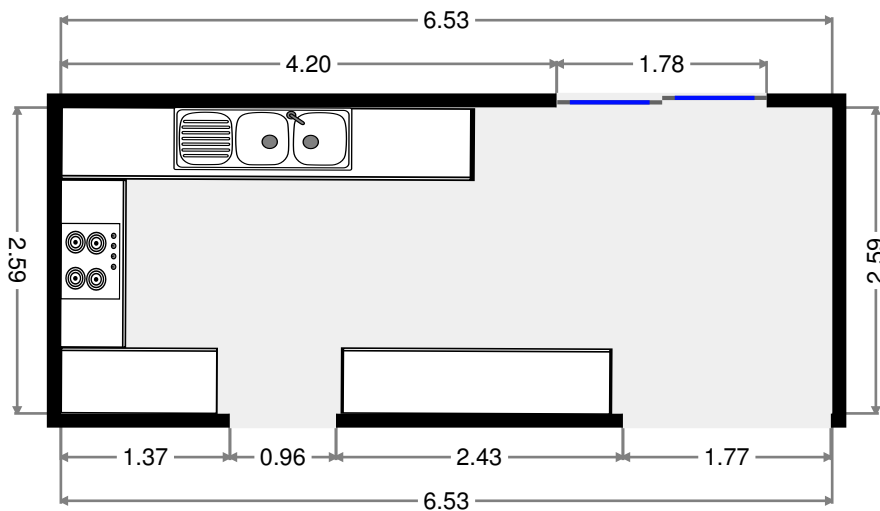
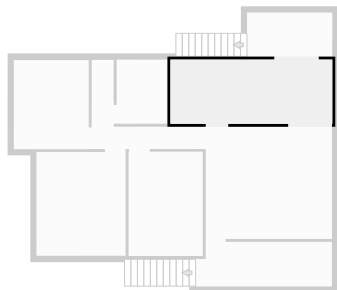

# Living Room

Width: 4.52 m  
 Length: 5.10 m  
 Area: 23.04 m<sup>2</sup>  
 Perimeter: 19.24 m

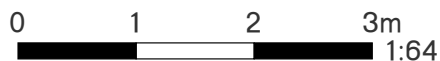
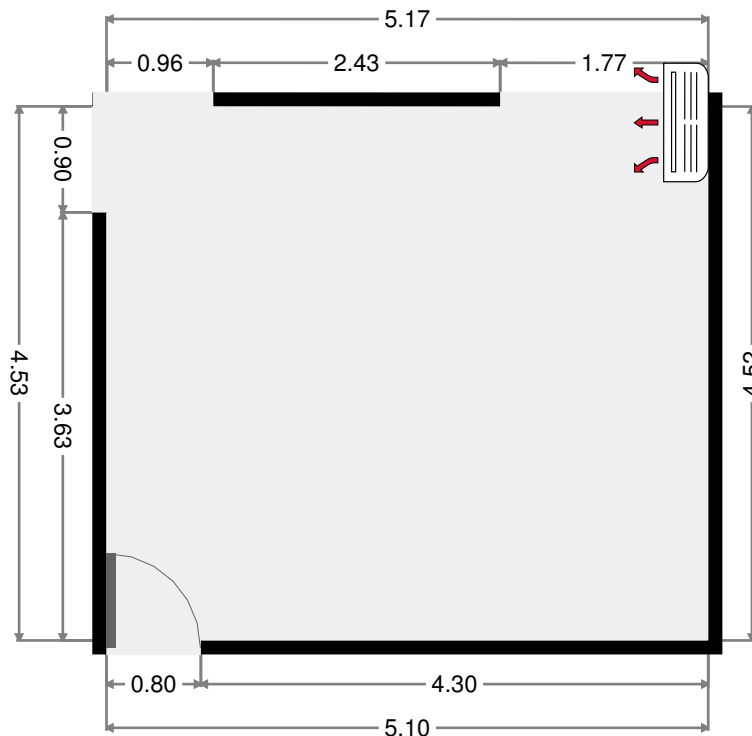
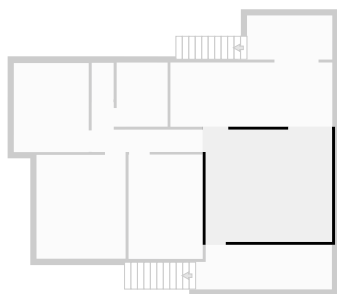

THIS FLOORPLAN IS PROVIDED WITHOUT WARRANTY OF ANY KIND. SENSOPIA DISCLAIMS ANY WARRANTY INCLUDING, WITHOUT LIMITATION, SATISFACTORY QUALITY OR ACCURACY OF DIMENSIONS.



# Hall

Width: 2.01 m  
 Length: 4.48 m  
 Area: 5.02 m<sup>2</sup>  
 Perimeter: 12.98 m

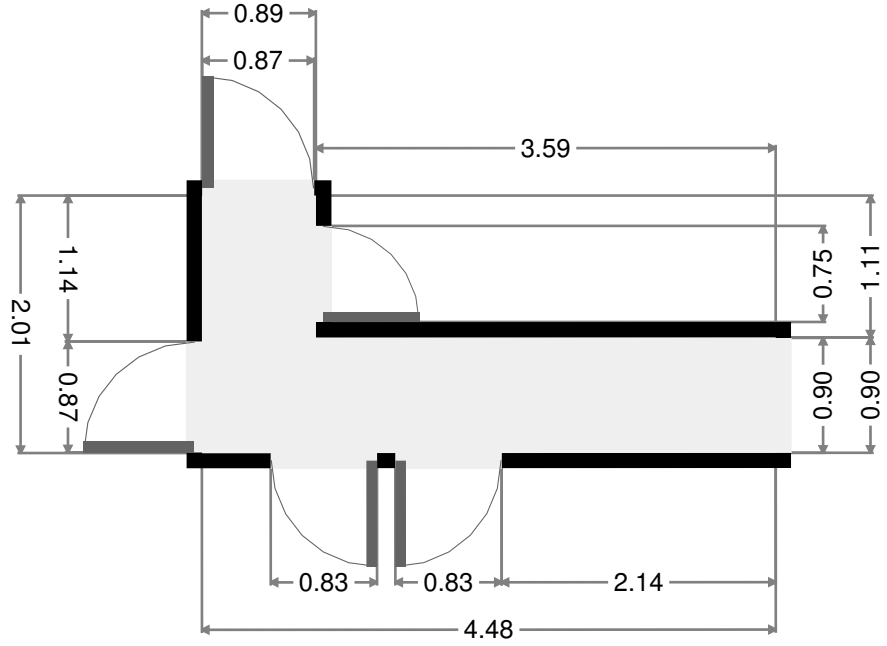
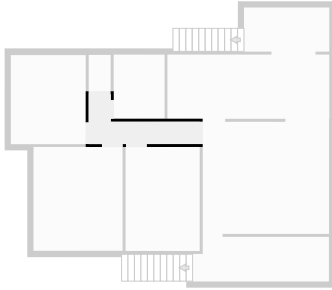

# Bedroom

Width: 2.99 m  
 Length: 4.22 m  
 Area: 12.60 m<sup>2</sup>  
 Perimeter: 14.40 m

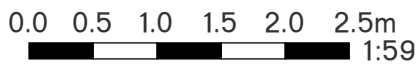
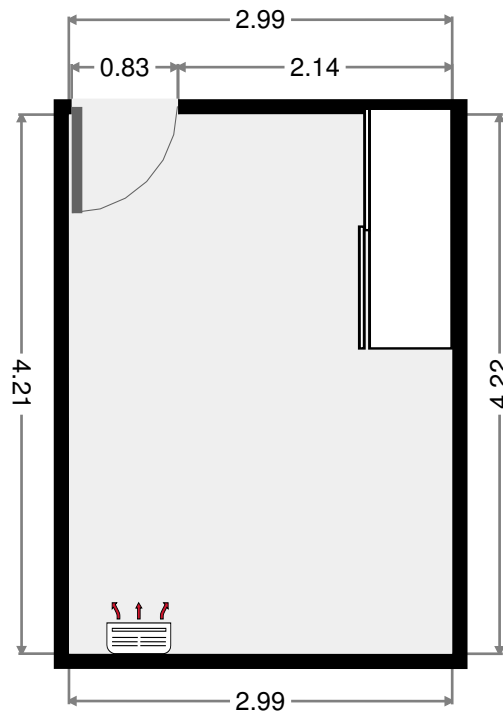
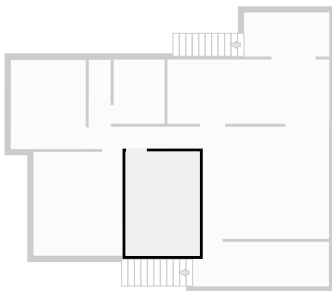

THIS FLOORPLAN IS PROVIDED WITHOUT WARRANTY OF ANY KIND. SENSOPIA DISCLAIMS ANY WARRANTY INCLUDING, WITHOUT LIMITATION, SATISFACTORY QUALITY OR ACCURACY OF DIMENSIONS.

# Master Bedroom

Width: 3.59 m  
 Length: 4.19 m  
 Area: 15.05 m<sup>2</sup>  
 Perimeter: 15.56 m

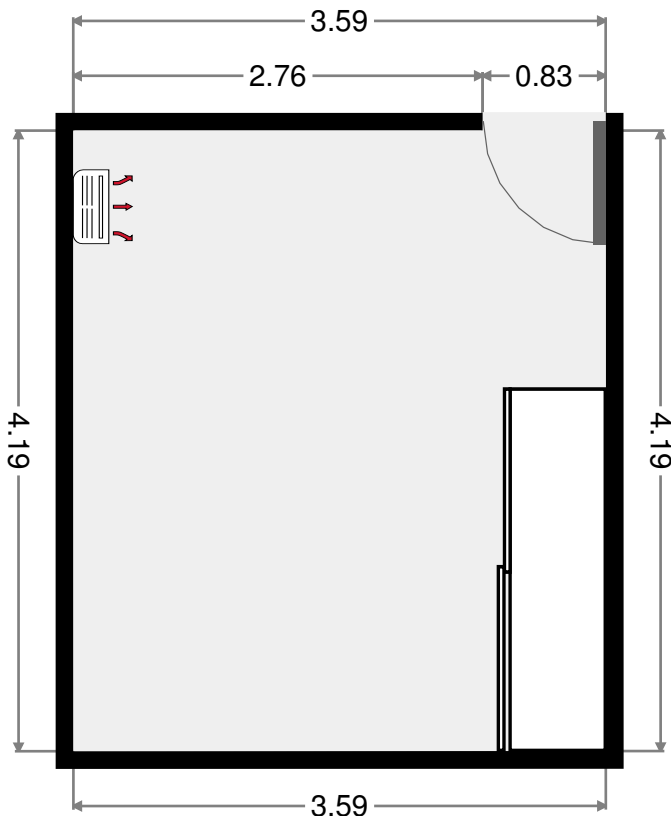
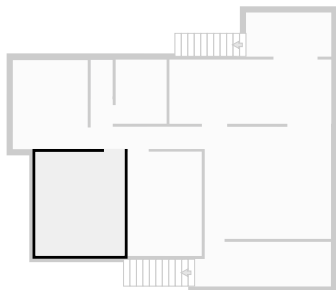

# Bedroom

Width: 3.02 m  
 Length: 3.59 m  
 Area: 10.85 m<sup>2</sup>  
 Perimeter: 13.23 m

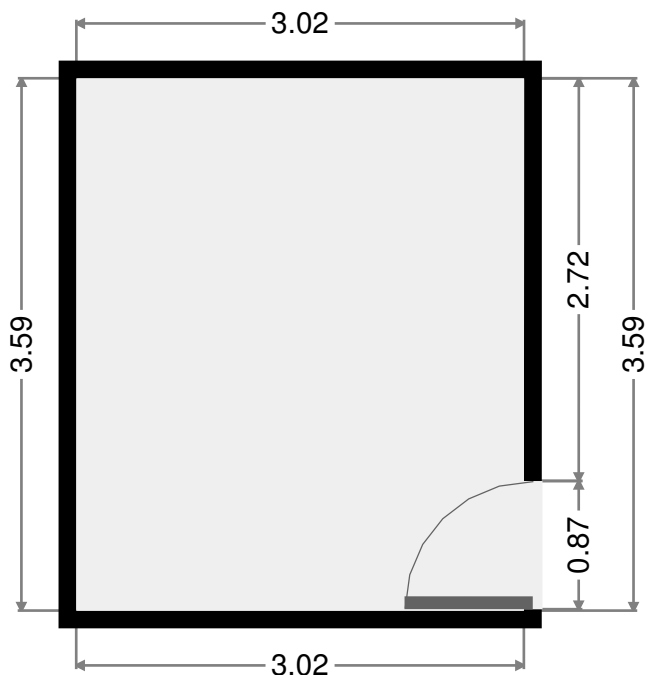
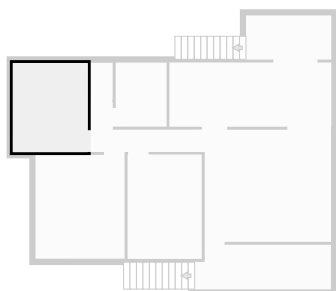

THIS FLOORPLAN IS PROVIDED WITHOUT WARRANTY OF ANY KIND. SENSOPIA DISCLAIMS ANY WARRANTY INCLUDING, WITHOUT LIMITATION, SATISFACTORY QUALITY OR ACCURACY OF DIMENSIONS.

# Toilet

Width: 0.88 m  
 Length: 1.48 m  
 Area: 1.30 m<sup>2</sup>  
 Perimeter: 4.72 m

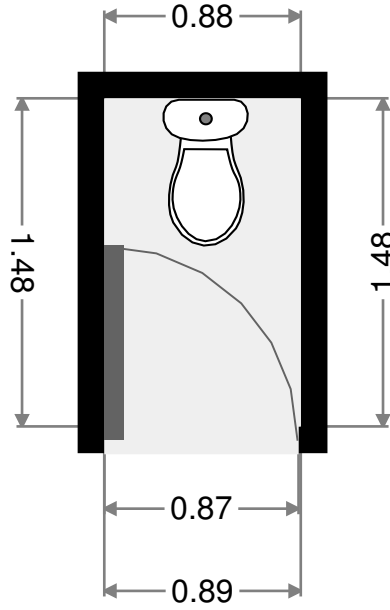
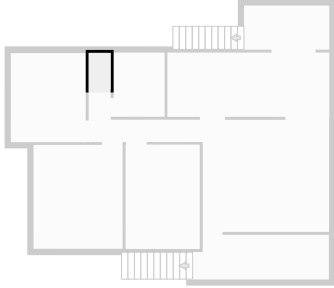

# Bathroom

Width: 2.06 m  
 Length: 2.59 m  
 Area: 5.31 m<sup>2</sup>  
 Perimeter: 9.28 m

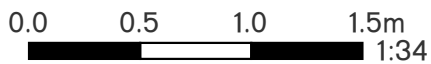
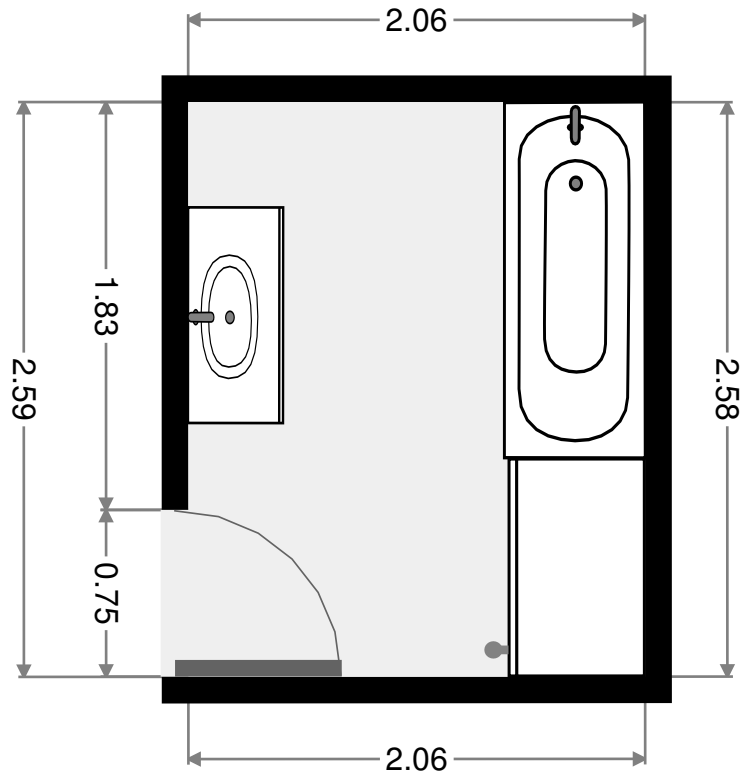
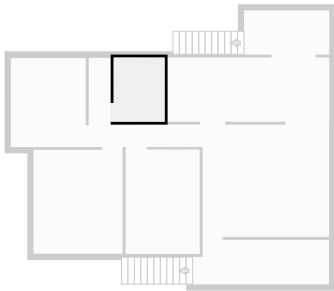

THIS FLOORPLAN IS PROVIDED WITHOUT WARRANTY OF ANY KIND. SENSOPIA DISCLAIMS ANY WARRANTY INCLUDING, WITHOUT LIMITATION, SATISFACTORY QUALITY OR ACCURACY OF DIMENSIONS.

# Front Verandah

Width: 1.80 m  
 Length: 5.51 m  
 Area: 9.63 m<sup>2</sup>  
 Perimeter: 14.61 m

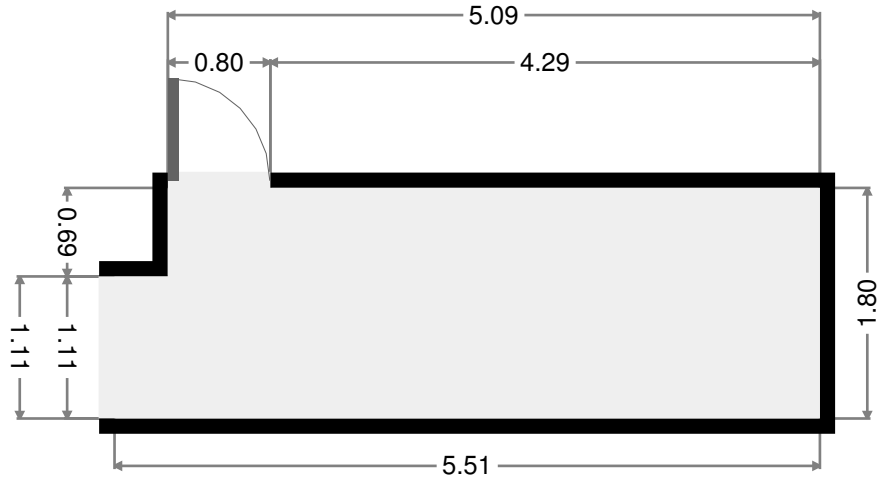
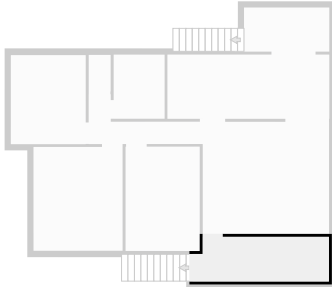

# Rear Verandah

Width: 1.78 m  
 Length: 3.44 m  
 Area: 6.12 m<sup>2</sup>  
 Perimeter: 10.44 m

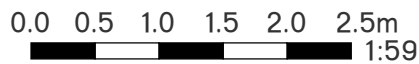
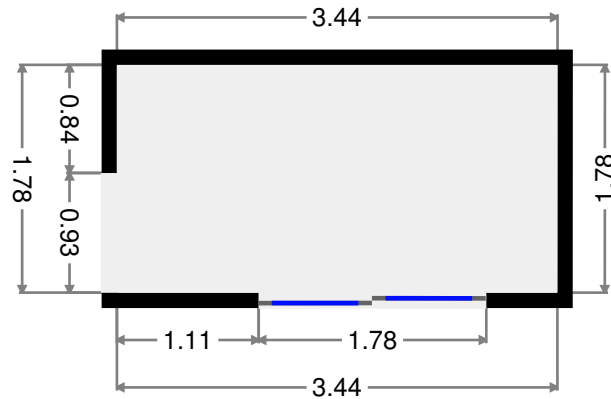
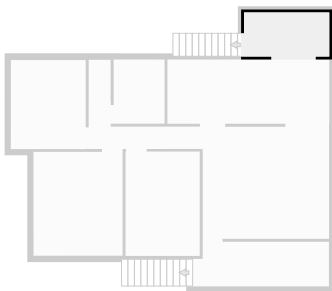

THIS FLOORPLAN IS PROVIDED WITHOUT WARRANTY OF ANY KIND. SENSOPIA DISCLAIMS ANY WARRANTY INCLUDING, WITHOUT LIMITATION, SATISFACTORY QUALITY OR ACCURACY OF DIMENSIONS.