

13 Peltophorum Street

SUBMITTED BY

Ray White Rockhampton Casey
stockers@cqoz.com

CREATED ON

2022-03-02

Floors

2

▼ Ground Floor

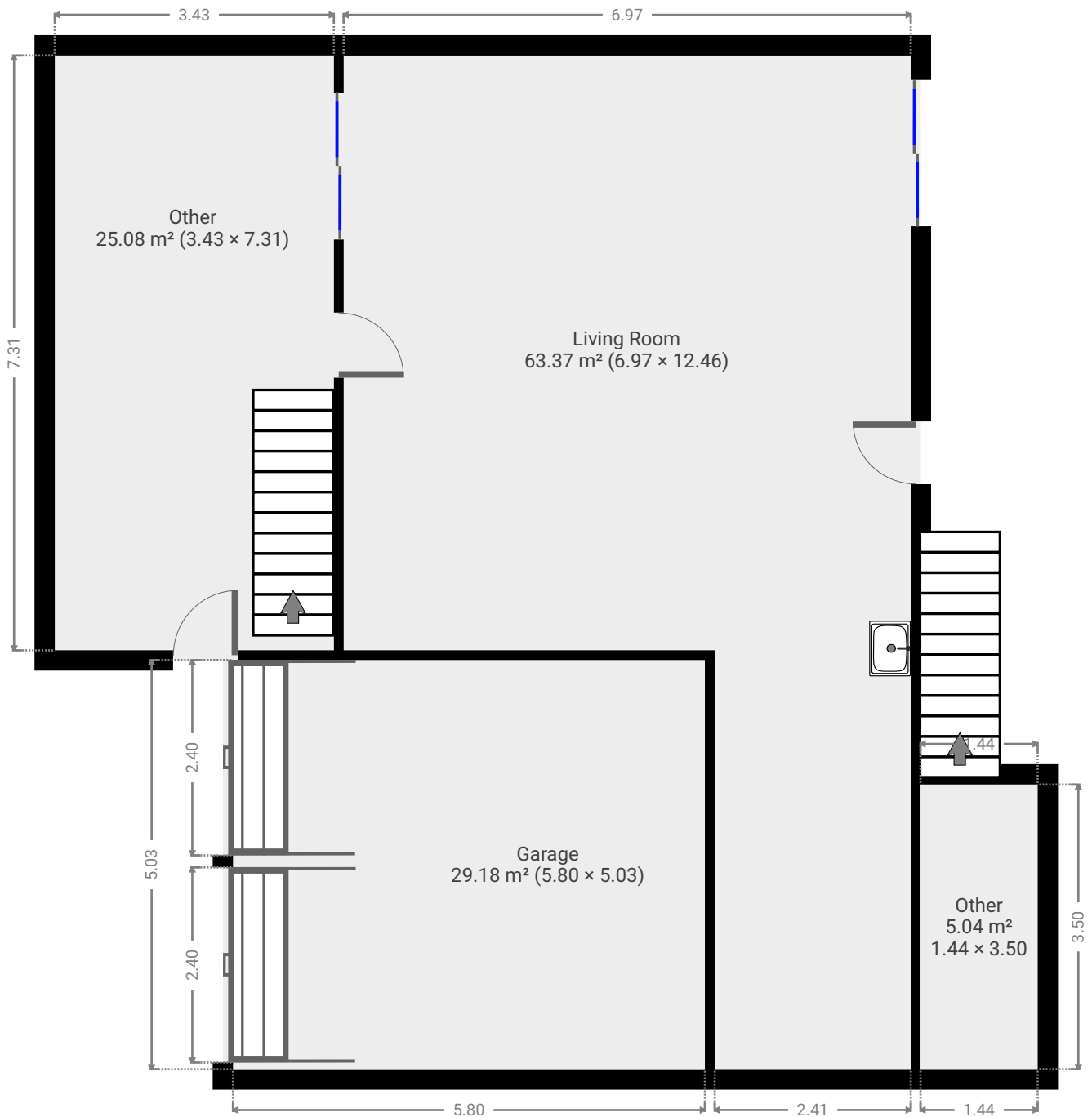

FLOORS: 2

▼ Living Room
Ground Floor

WIDTH: 12.46 m • LENGTH: 6.97 m
AREA: 63.37 m² • PERIMETER: 38.86 m

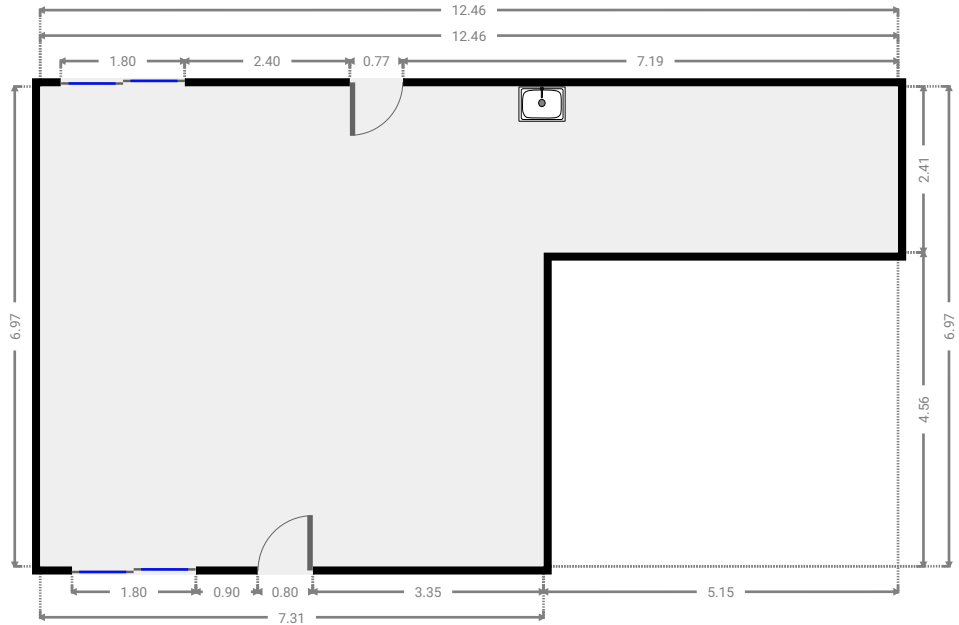
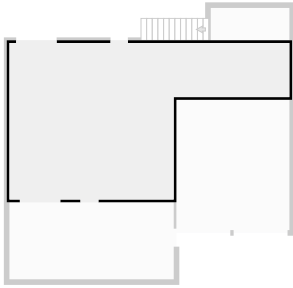

▼ Garage
Ground Floor

WIDTH: 5.03 m • LENGTH: 5.80 m
AREA: 29.18 m² • PERIMETER: 21.66 m

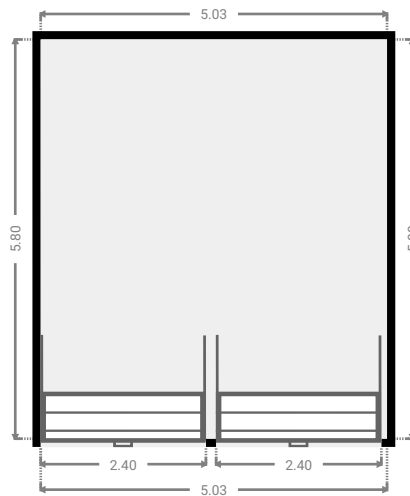
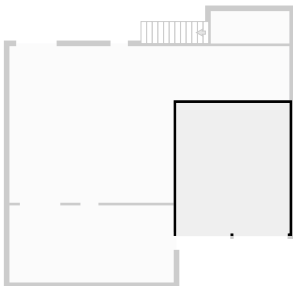

FLOORS: 2

▼ Other
Ground Floor

WIDTH: 3.50 m • LENGTH: 1.44 m
AREA: 5.04 m² • PERIMETER: 9.88 m

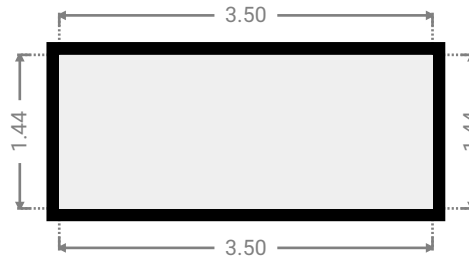
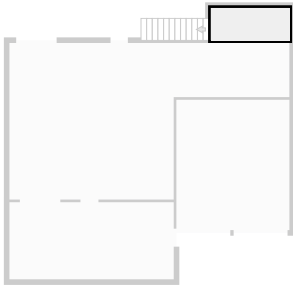

▼ Other
Ground Floor

WIDTH: 7.31 m • LENGTH: 3.43 m
AREA: 25.08 m² • PERIMETER: 21.49 m

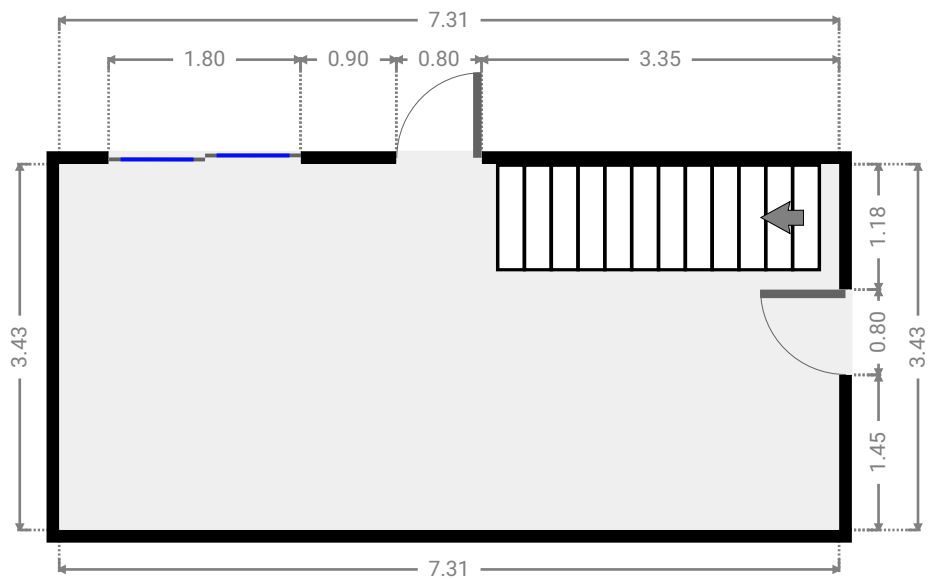
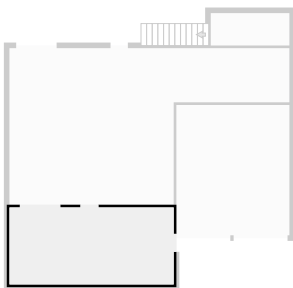

▼ 1st Floor

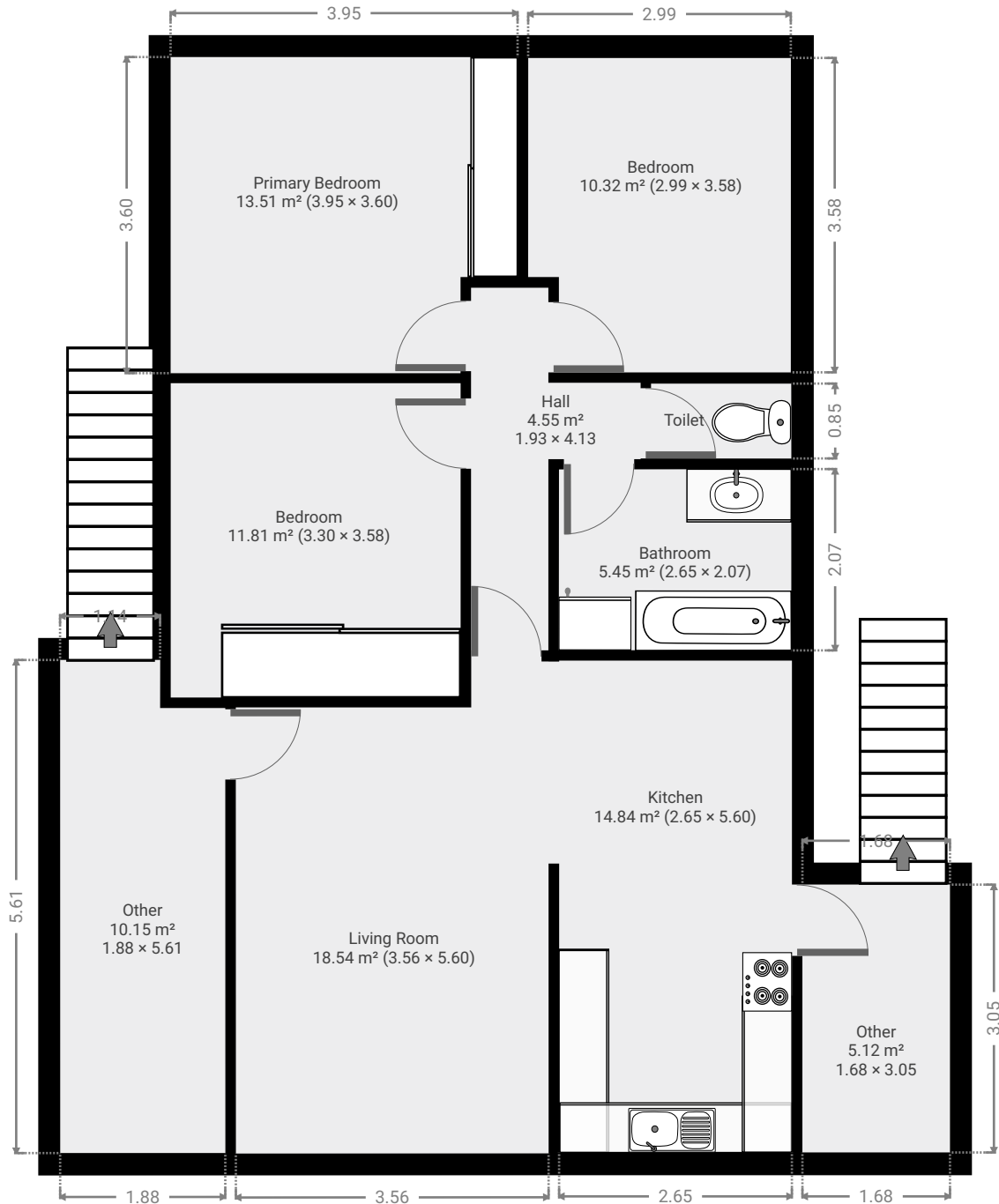

▼ **Living Room**
1st Floor

WIDTH: 5.60 m • LENGTH: 3.56 m
AREA: 18.54 m² • PERIMETER: 18.32 m

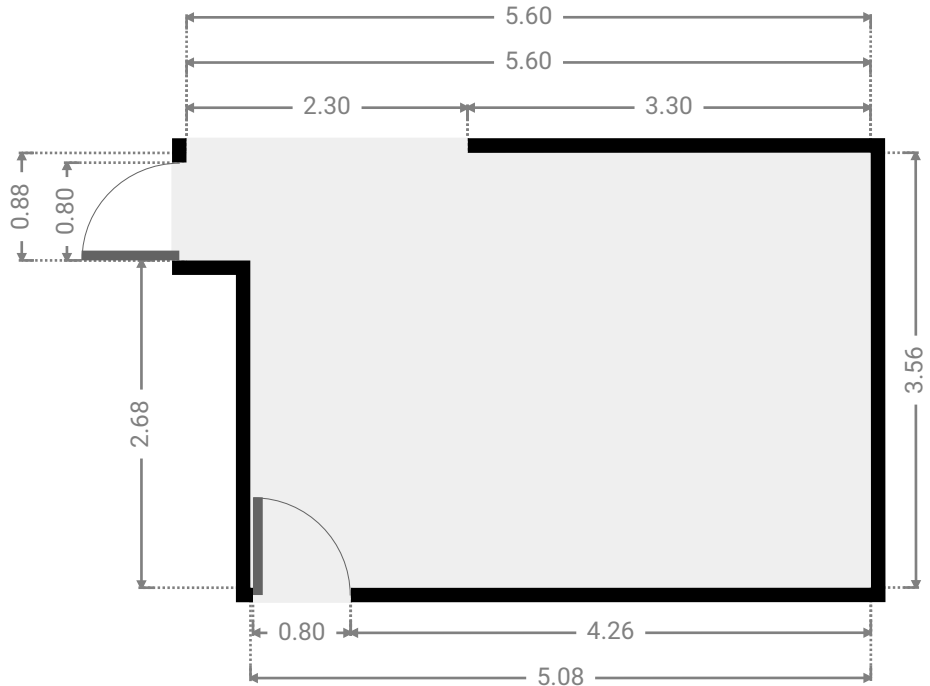
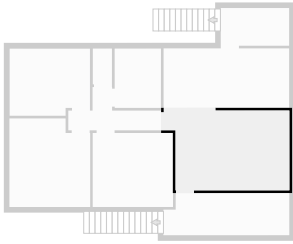

▼ **Kitchen**
1st Floor

WIDTH: 5.60 m • LENGTH: 2.65 m
AREA: 14.84 m² • PERIMETER: 16.50 m

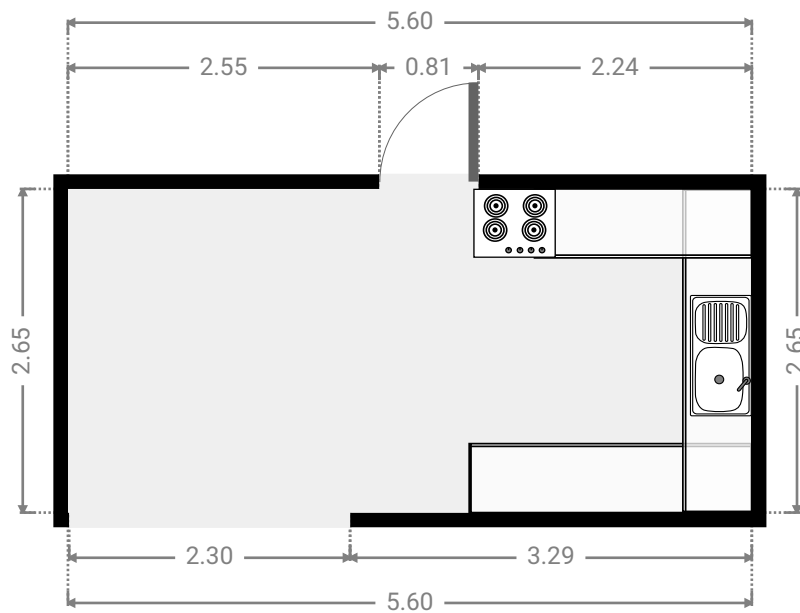
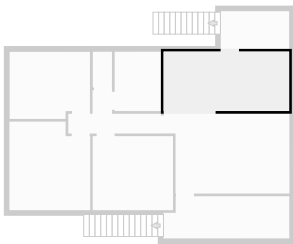

▼ **Hall**
1st Floor

WIDTH: 4.13 m • LENGTH: 1.93 m
AREA: 4.55 m² • PERIMETER: 12.12 m

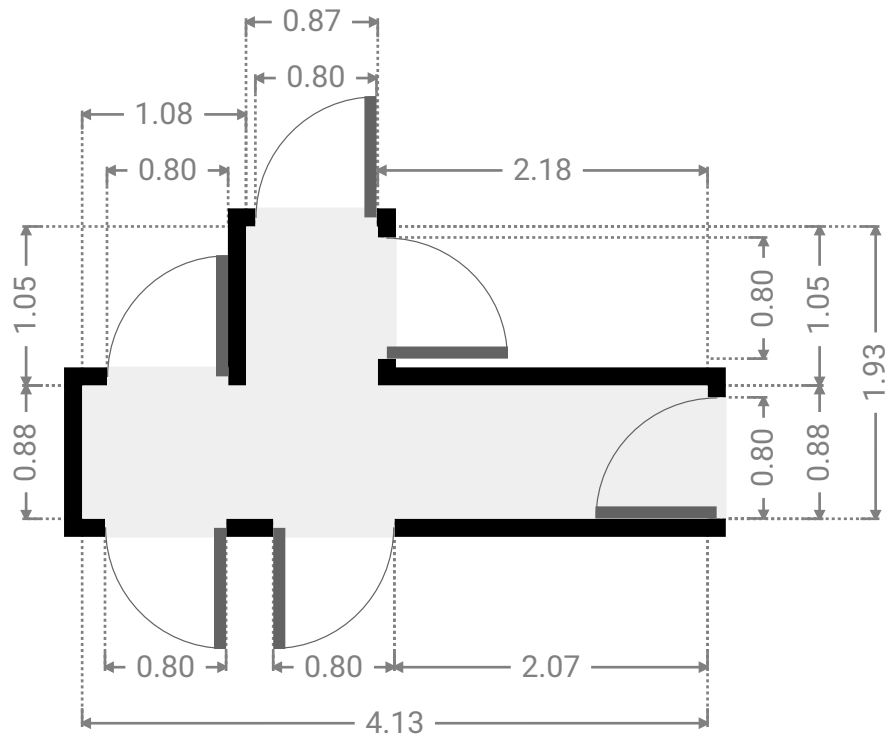
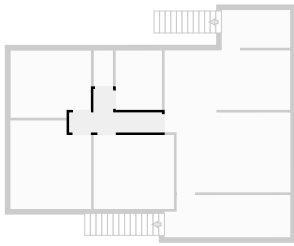

▼ **Bedroom**
1st Floor

WIDTH: 3.58 m • LENGTH: 3.30 m
AREA: 11.81 m² • PERIMETER: 13.76 m

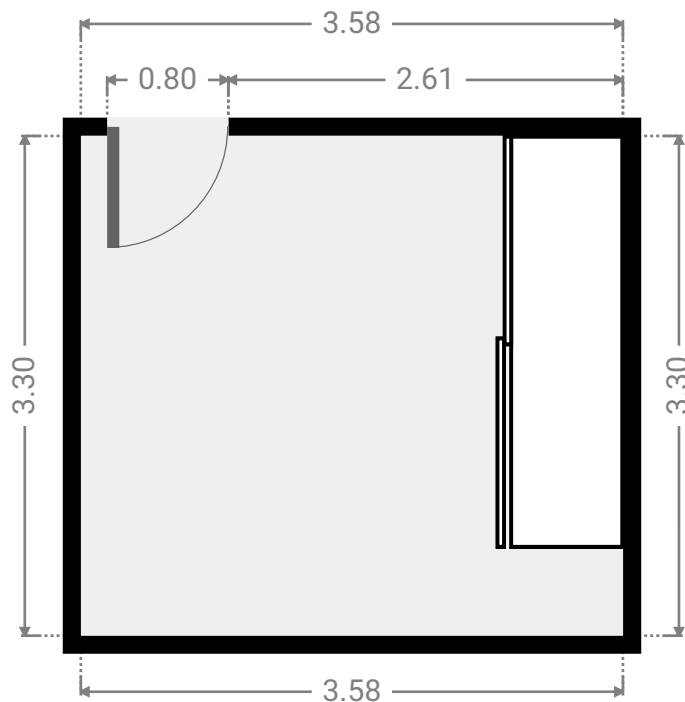
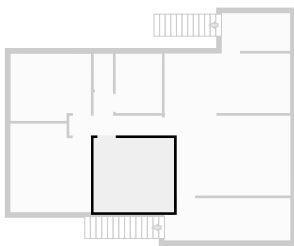

▼ **Primary Bedroom**
1st Floor

WIDTH: 3.60 m • LENGTH: 3.95 m
AREA: 13.51 m² • PERIMETER: 15.10 m

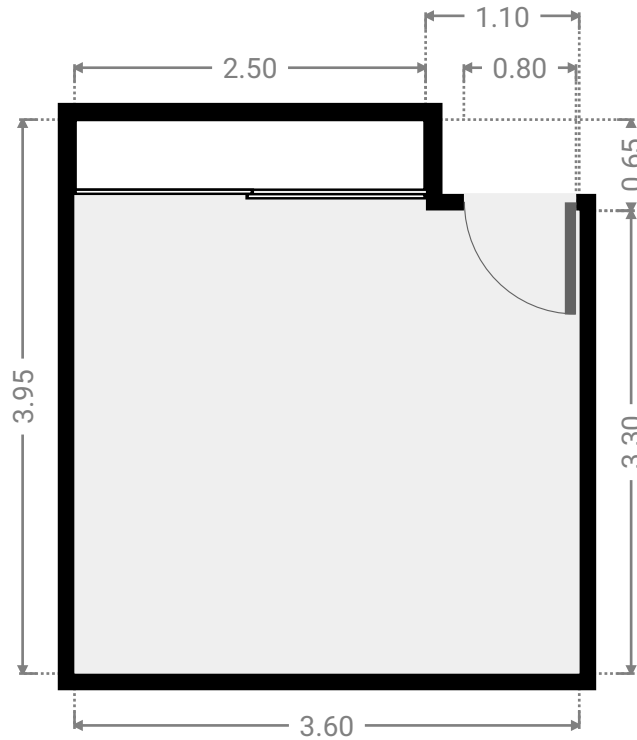
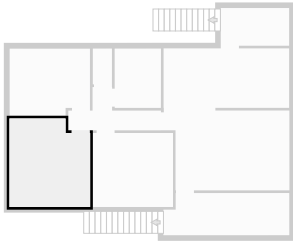

▼ **Bedroom**
1st Floor

WIDTH: 3.58 m • LENGTH: 2.99 m
AREA: 10.32 m² • PERIMETER: 13.14 m

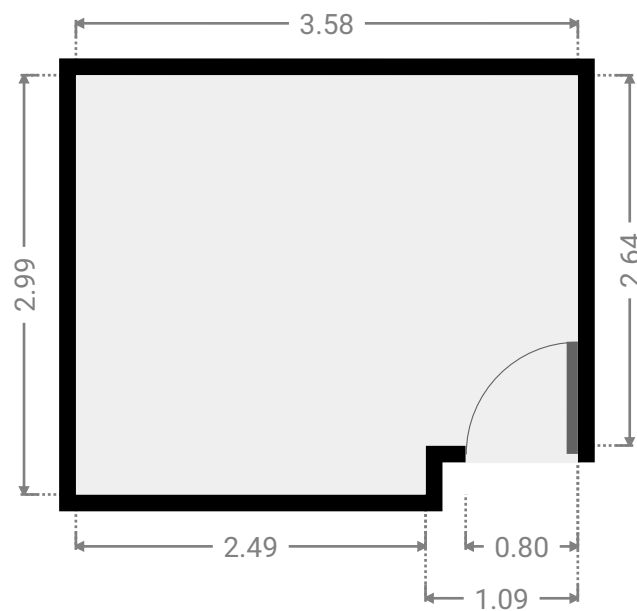
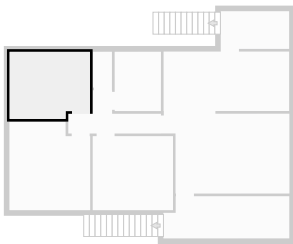

▼ **Toilet**
1st Floor

WIDTH: 0.85 m • LENGTH: 1.60 m
AREA: 1.36 m² • PERIMETER: 4.90 m

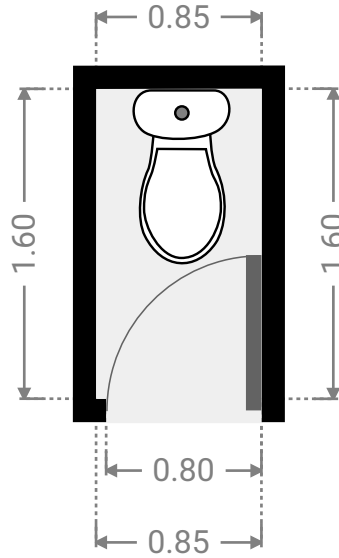
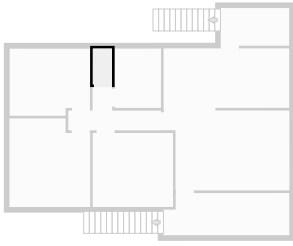

▼ **Bathroom**
1st Floor

WIDTH: 2.07 m • LENGTH: 2.65 m
AREA: 5.45 m² • PERIMETER: 9.41 m

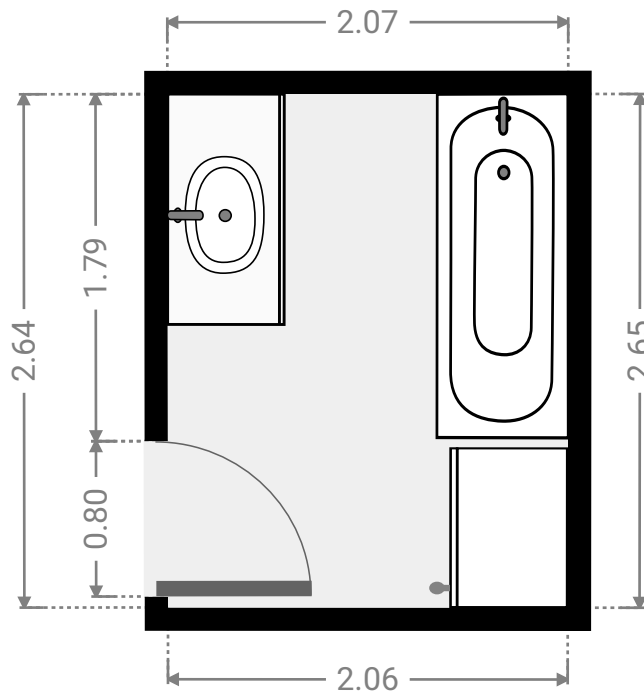
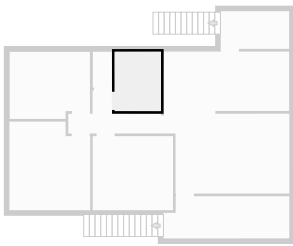

▼ Other
1st Floor

WIDTH: 3.05 m • LENGTH: 1.68 m
AREA: 5.12 m² • PERIMETER: 9.46 m

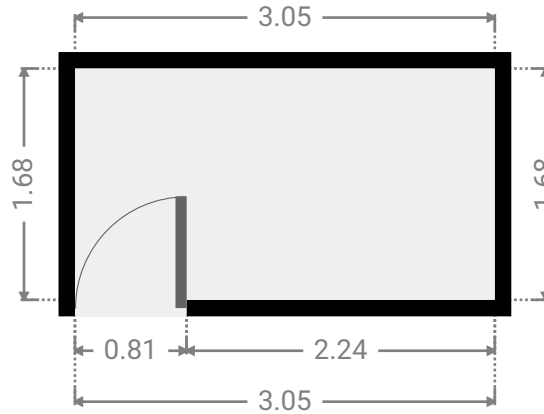
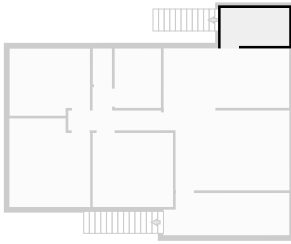

▼ Other
1st Floor

WIDTH: 5.61 m • LENGTH: 1.88 m
AREA: 10.15 m² • PERIMETER: 14.99 m

