

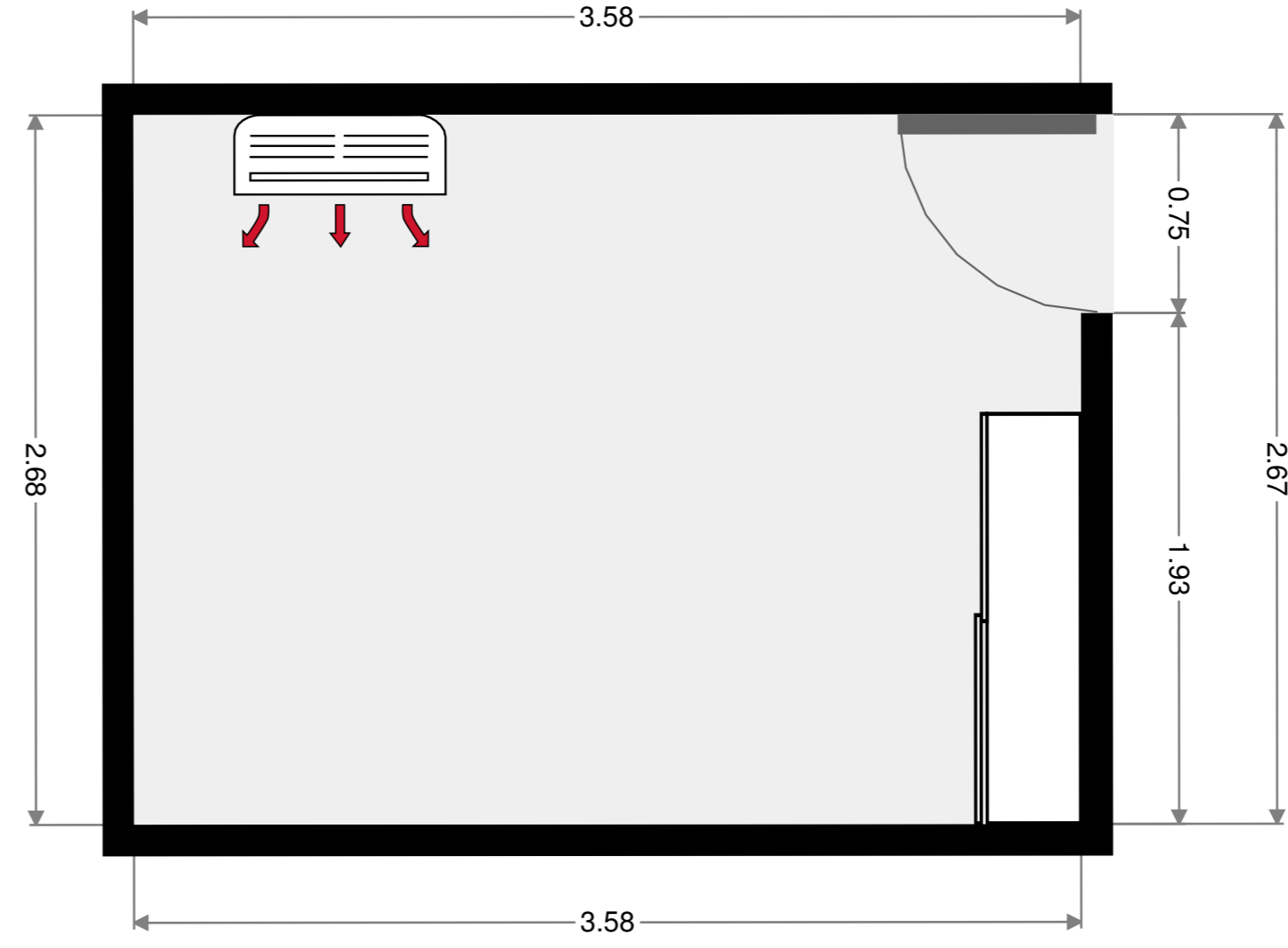

Bedroom

Width: 2.68 m
 Length: 3.58 m
 Area: 9.58 m²
 Perimeter: 12.51 m

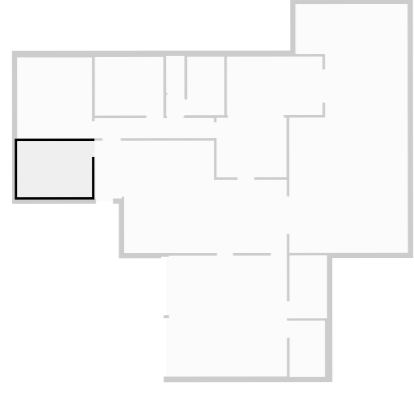

Foyer

Width: 1.32 m
 Length: 2.78 m
 Area: 3.66 m²
 Perimeter: 8.19 m

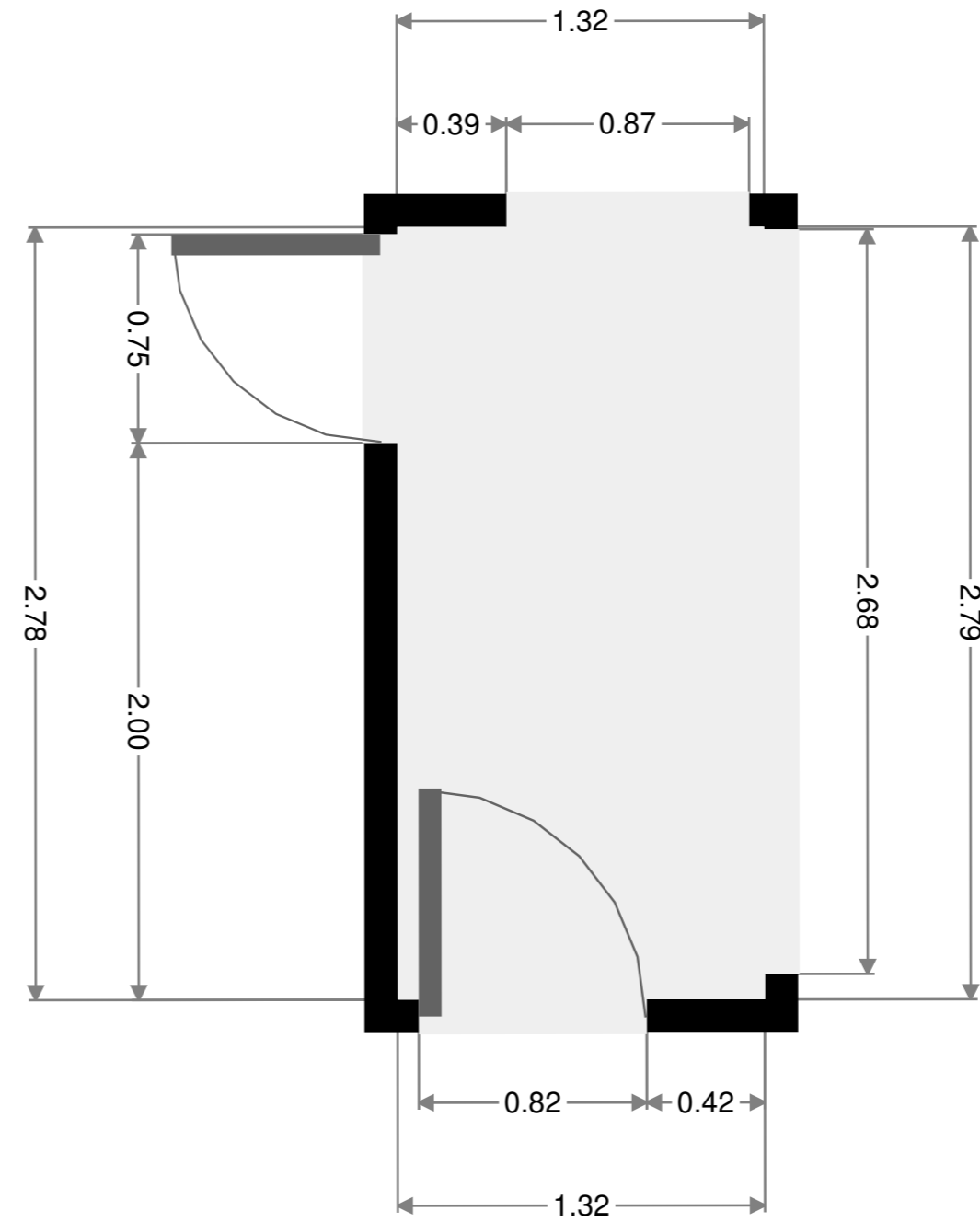
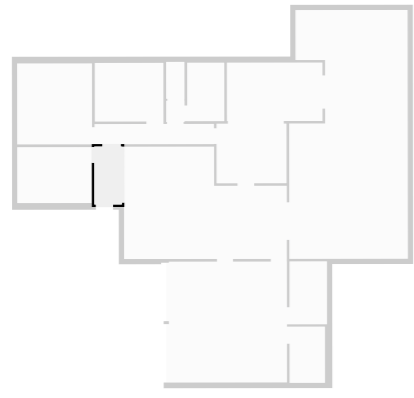

Living Room

Width: 4.32 m
 Length: 5.38 m
 Area: 23.24 m²
 Perimeter: 19.40 m

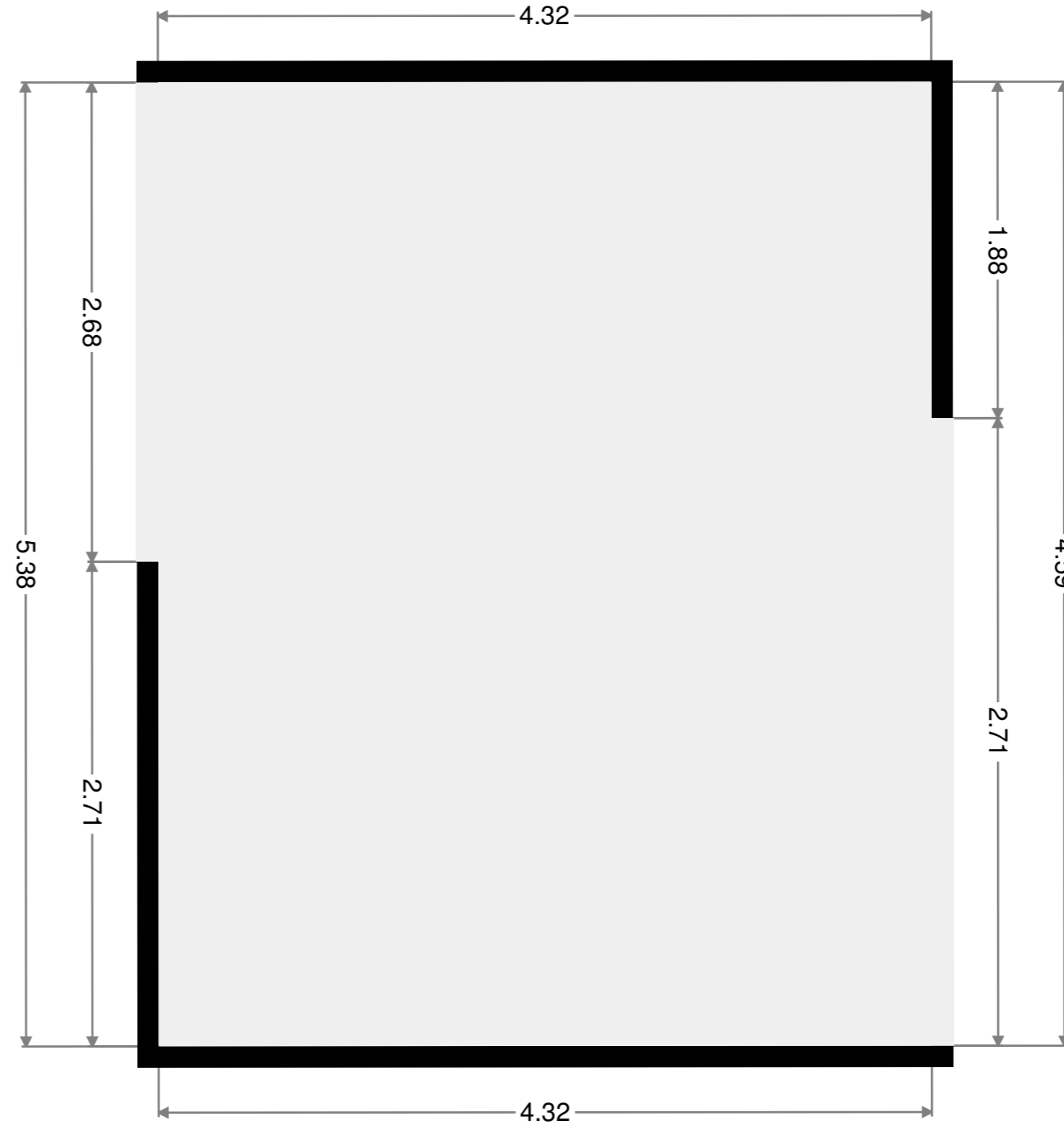
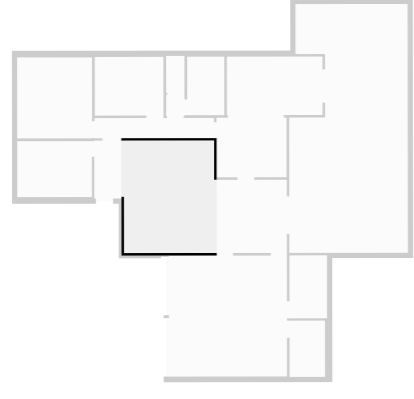

Width: 3.38 m
 Length: 3.51 m
 Area: 11.83 m²
 Perimeter: 13.76 m

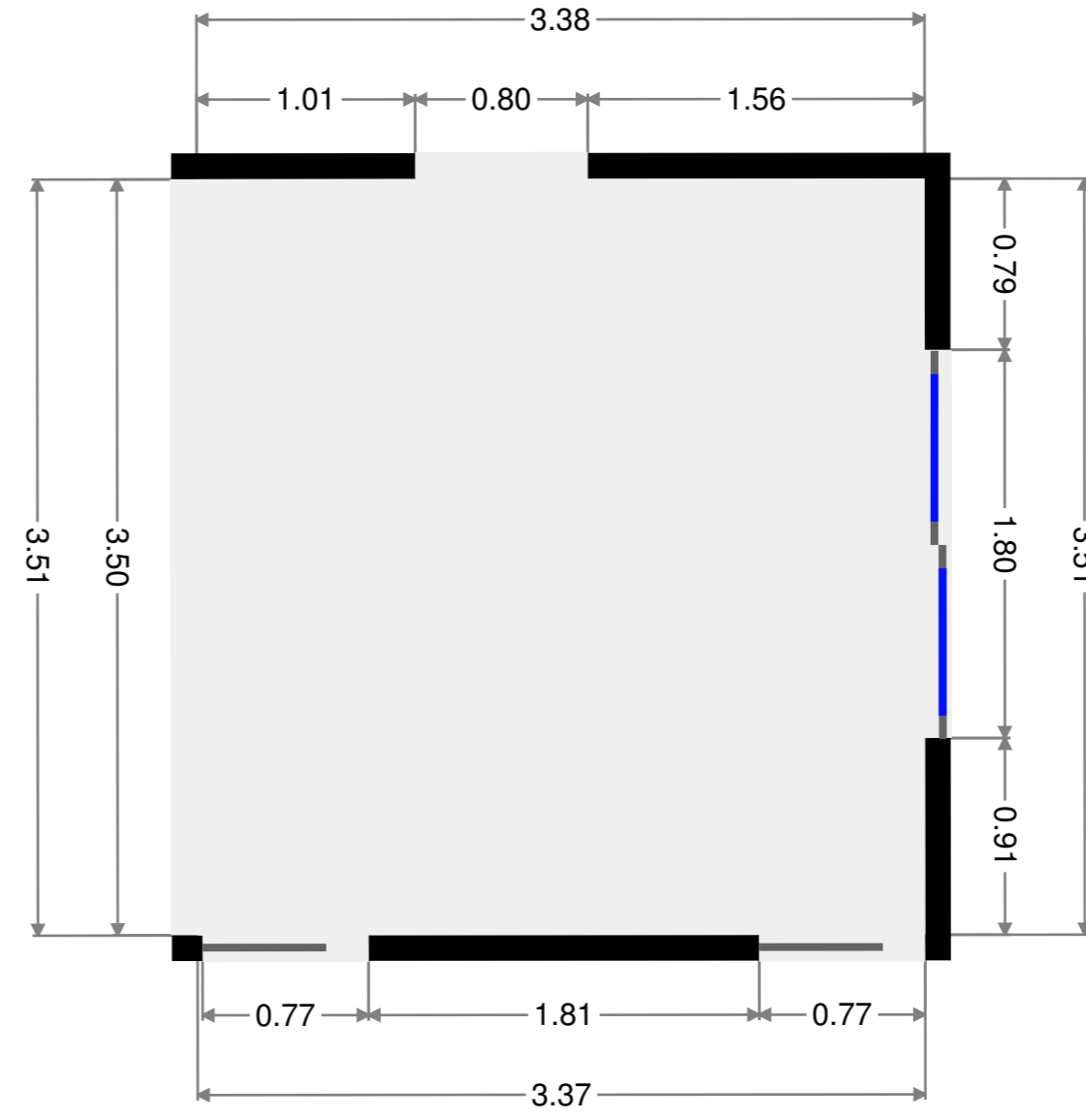
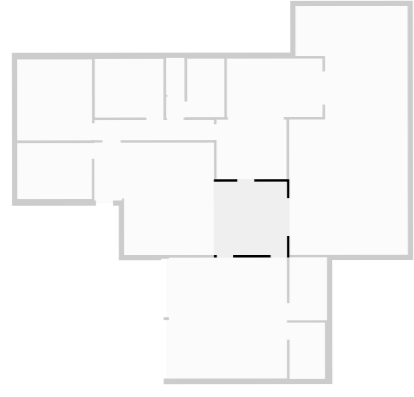

Hall

Width: 0.97 m
Length: 5.72 m
Area: 5.55 m²
Perimeter: 13.38 m

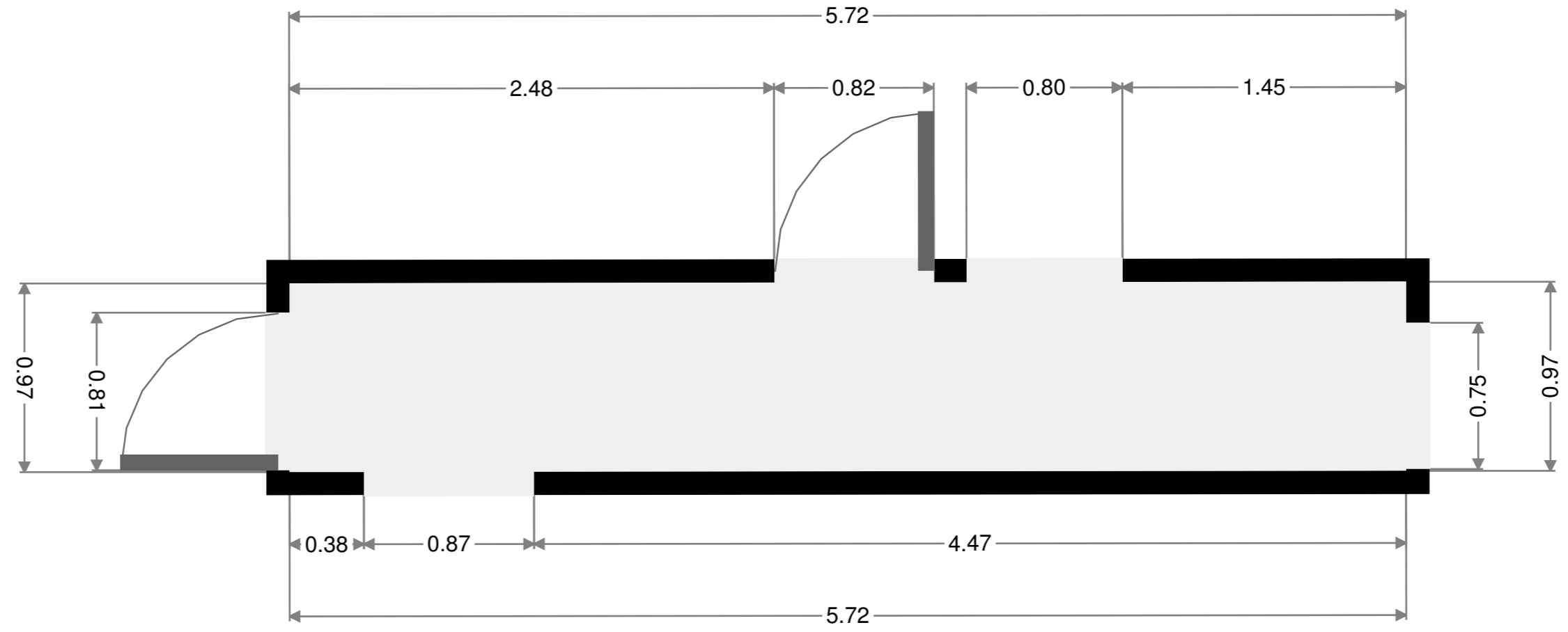
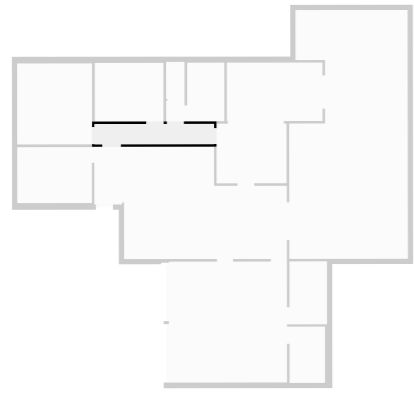

Bedroom

Width: 3.59 m
Length: 3.88 m
Area: 13.91 m²
Perimeter: 14.93 m

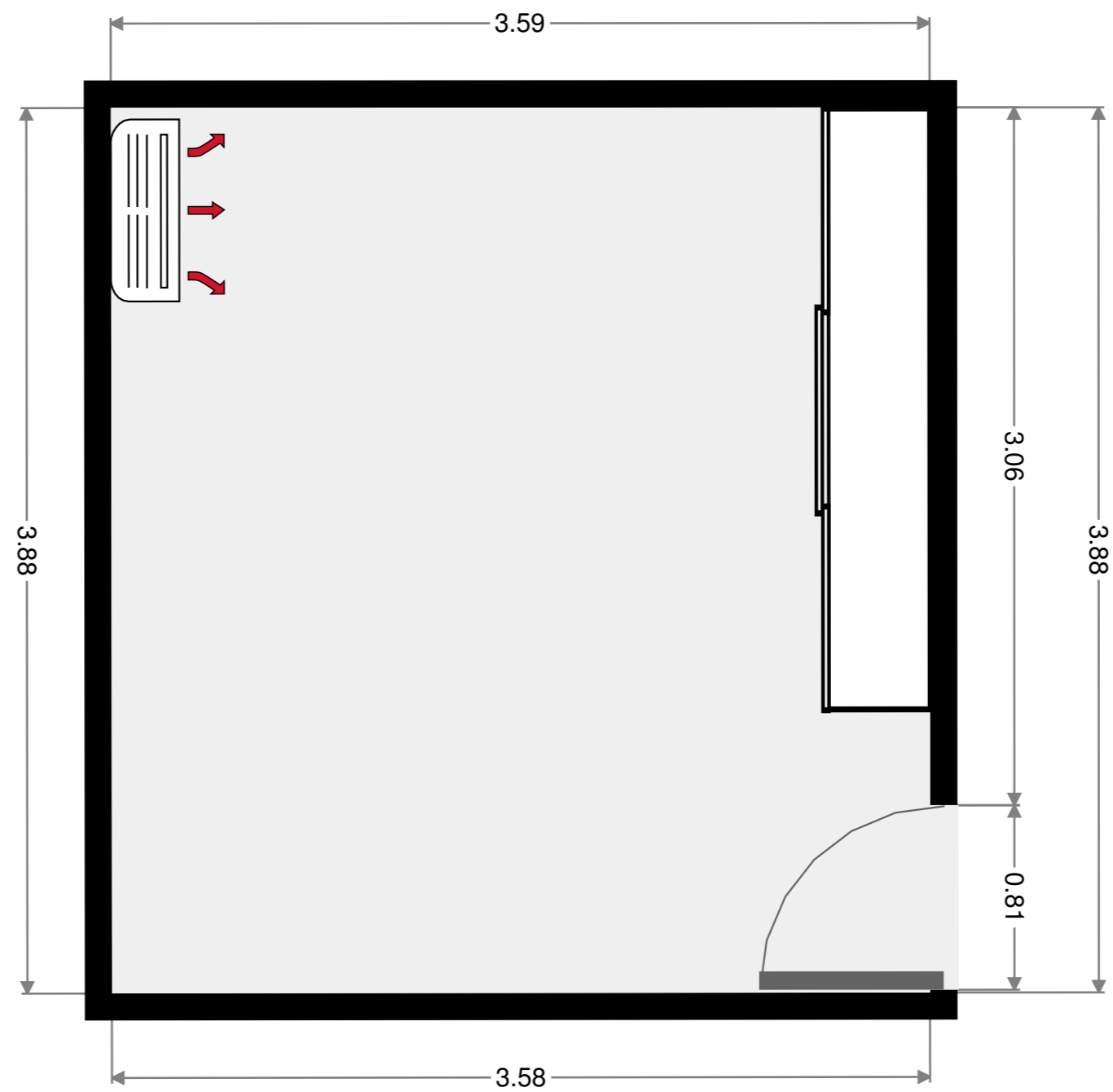
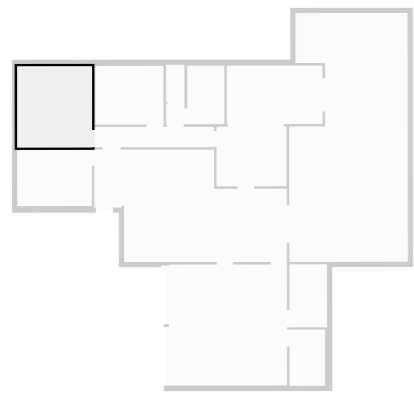

Bedroom

Width: 2.81 m
 Length: 3.29 m
 Area: 9.24 m²
 Perimeter: 12.20 m

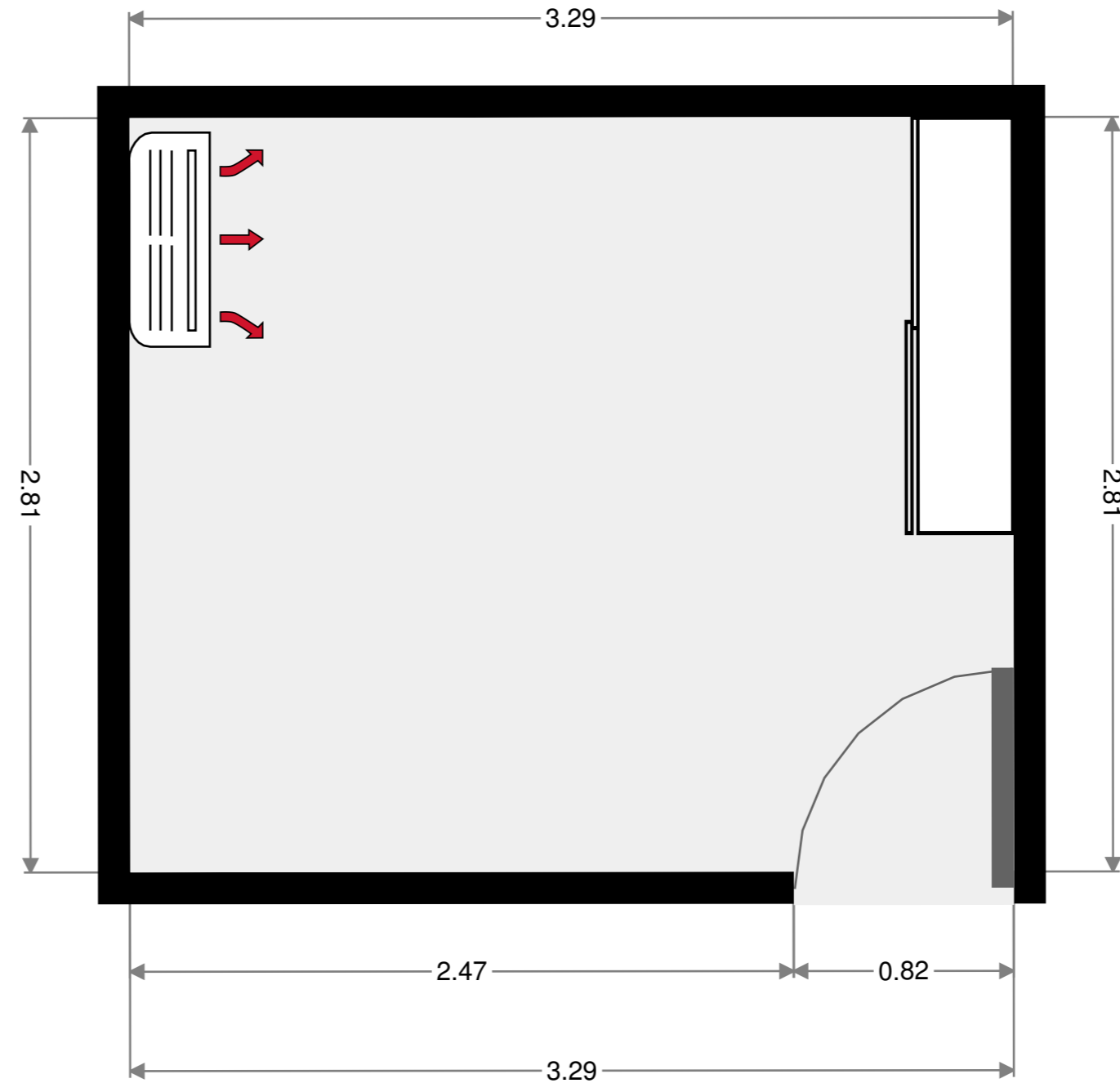
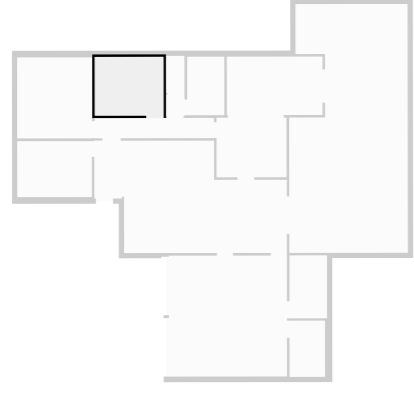

Width: 0.88 m
 Length: 1.02 m
 Area: 0.90 m²
 Perimeter: 3.80 m

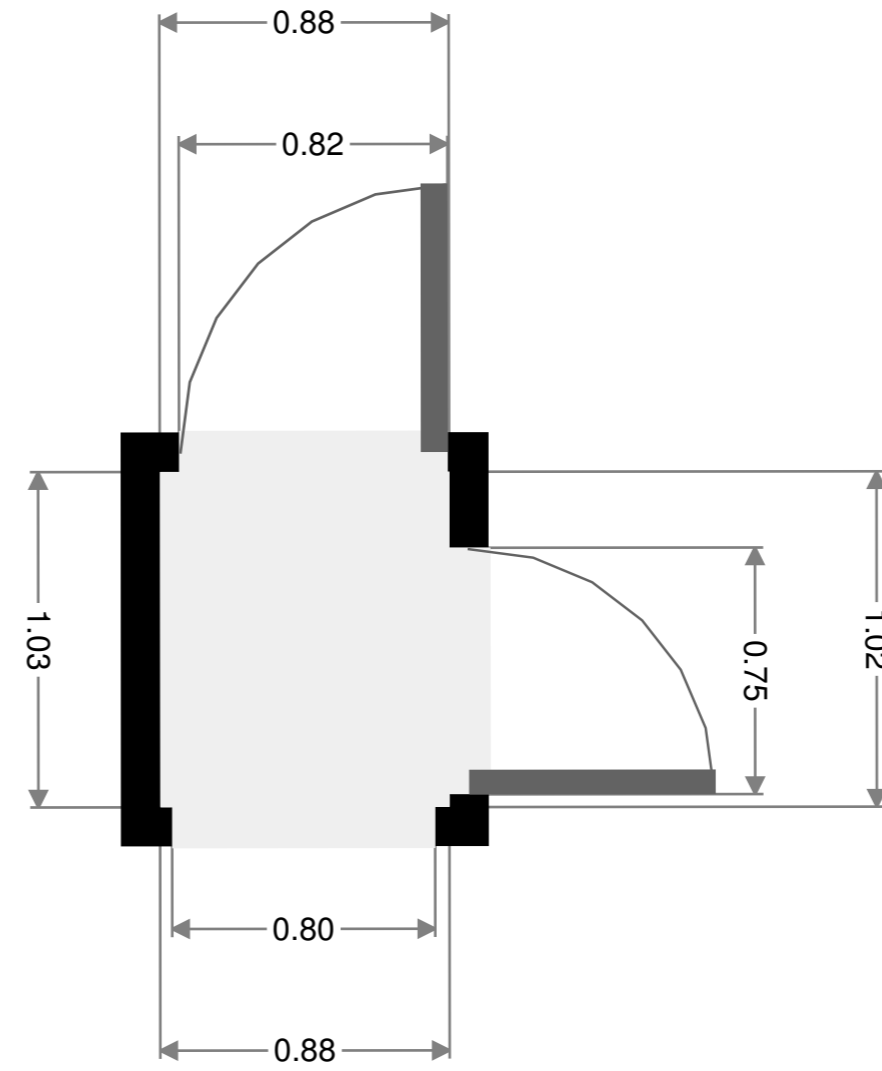
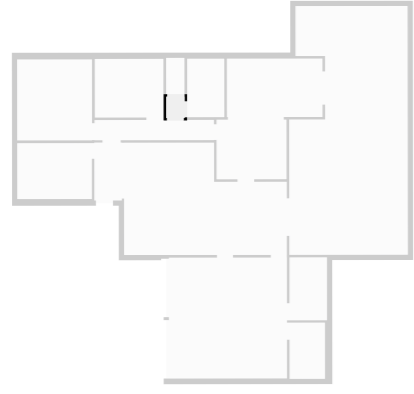

Toilet

Width: 0.88 m
Length: 1.78 m
Area: 1.56 m²
Perimeter: 5.30 m

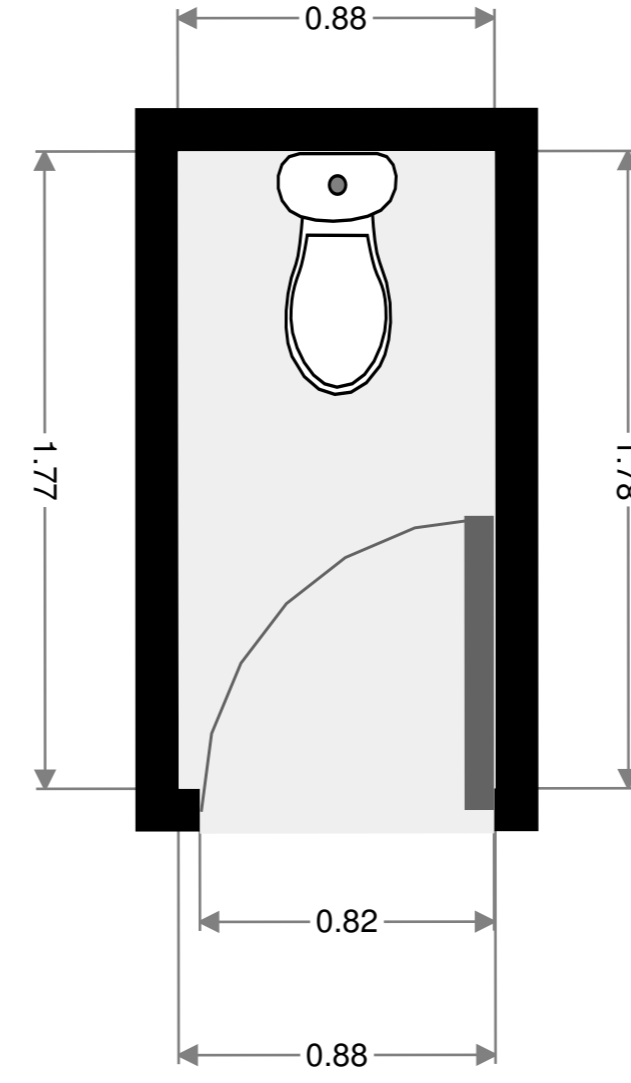

Bathroom

Width: 1.78 m
Length: 2.80 m
Area: 4.99 m²
Perimeter: 9.17 m

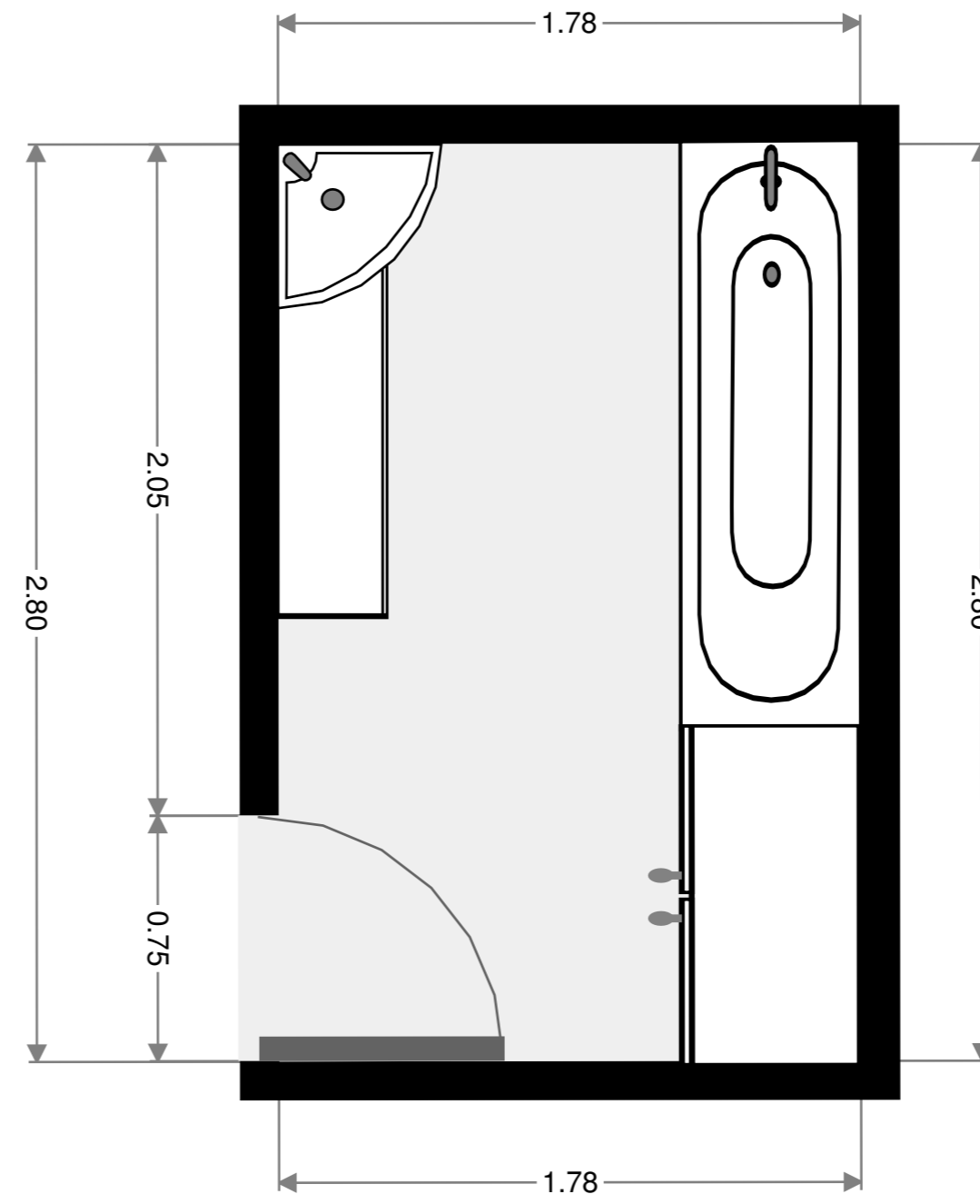
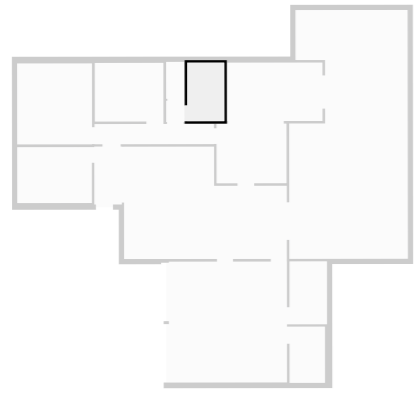

Kitchen

Width: 2.86 m
 Length: 3.36 m
 Area: 9.59 m²
 Perimeter: 12.43 m

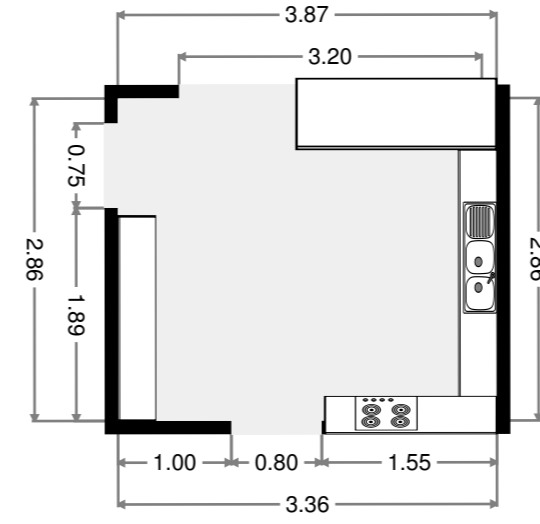
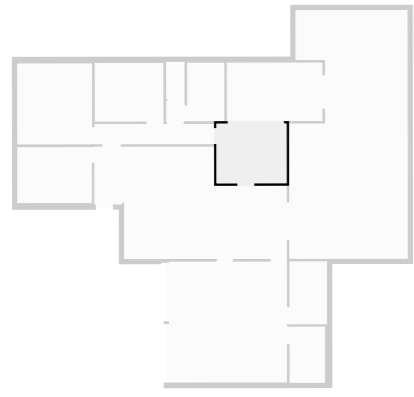

Outdoor Area

Width: 5.68 m
 Length: 11.92 m
 Area: 61.77 m²
 Perimeter: 38.04 m
 Ceiling Height: 2.17 m

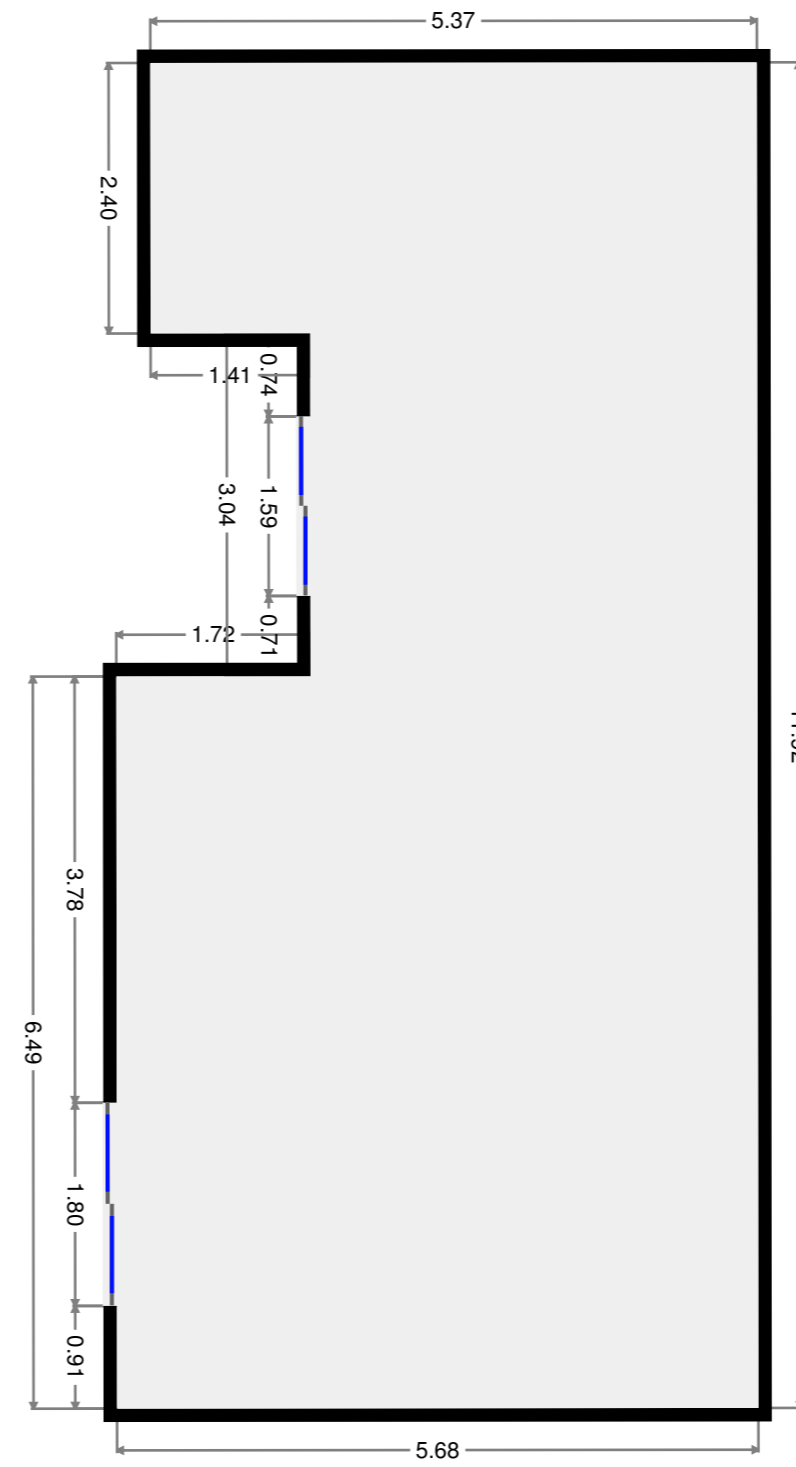
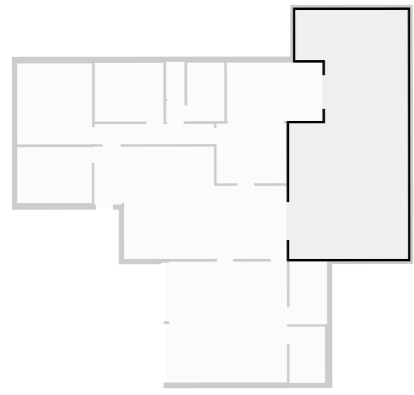

Dining Room

Width: 2.80 m
 Length: 4.58 m
 Area: 12.84 m²
 Perimeter: 14.77 m

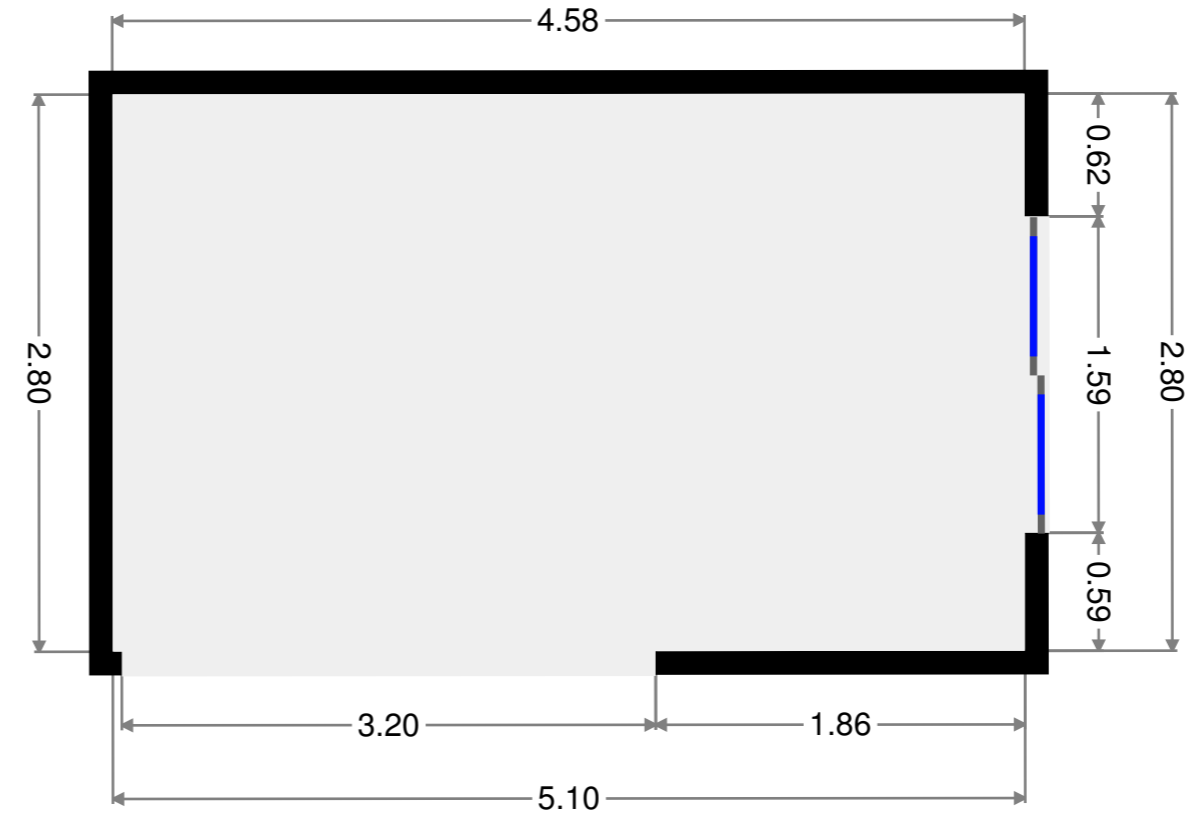
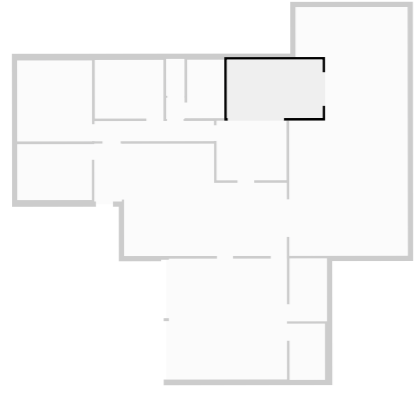

Garage

Width: 5.66 m
 Length: 5.79 m
 Area: 32.78 m²
 Perimeter: 22.90 m

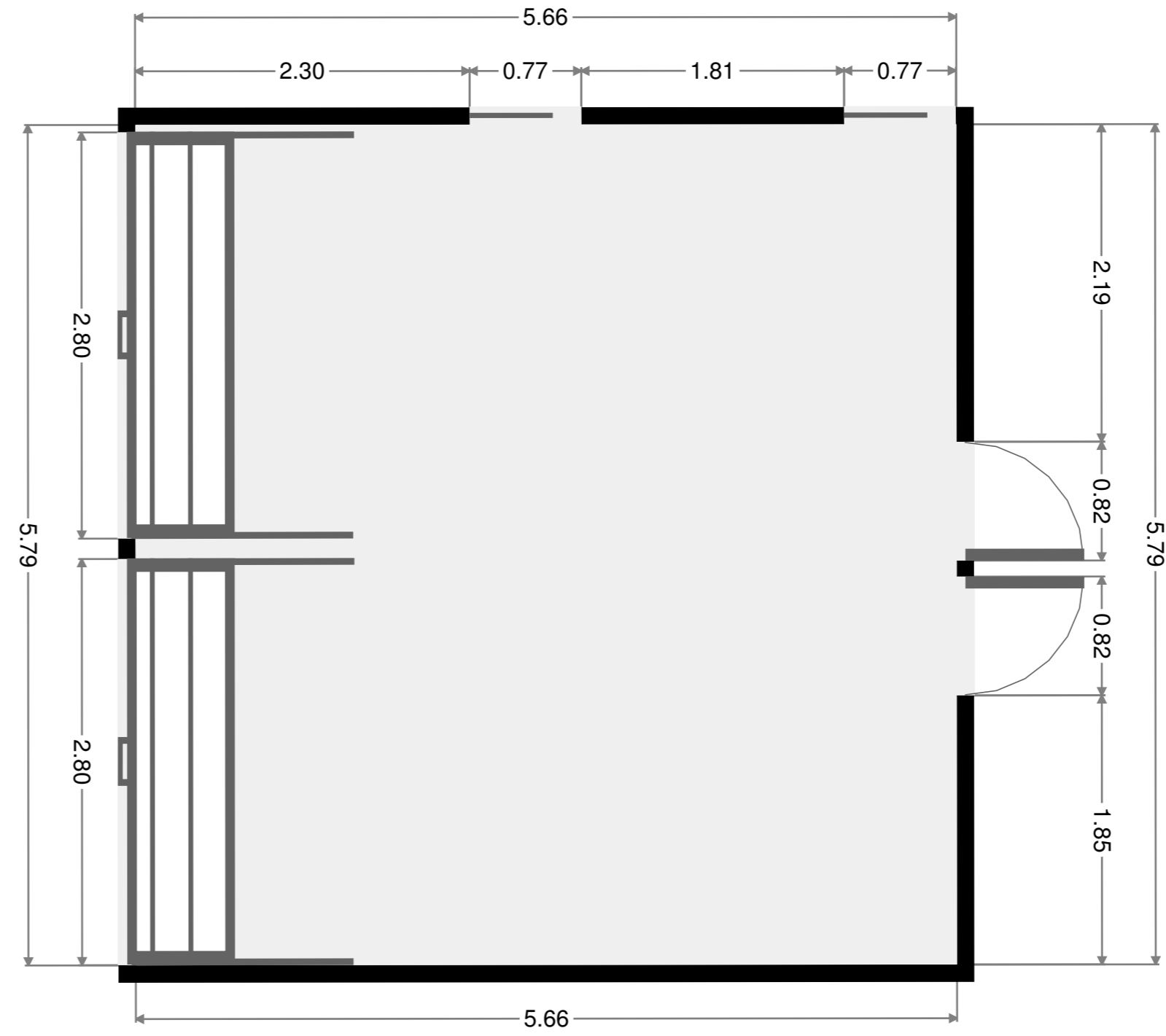
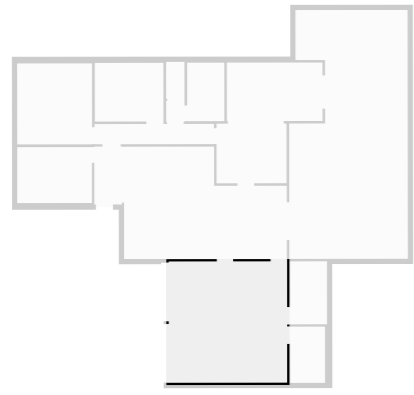

Laundry Room

Width: 1.80 m
 Length: 3.02 m
 Area: 5.43 m²
 Perimeter: 9.63 m

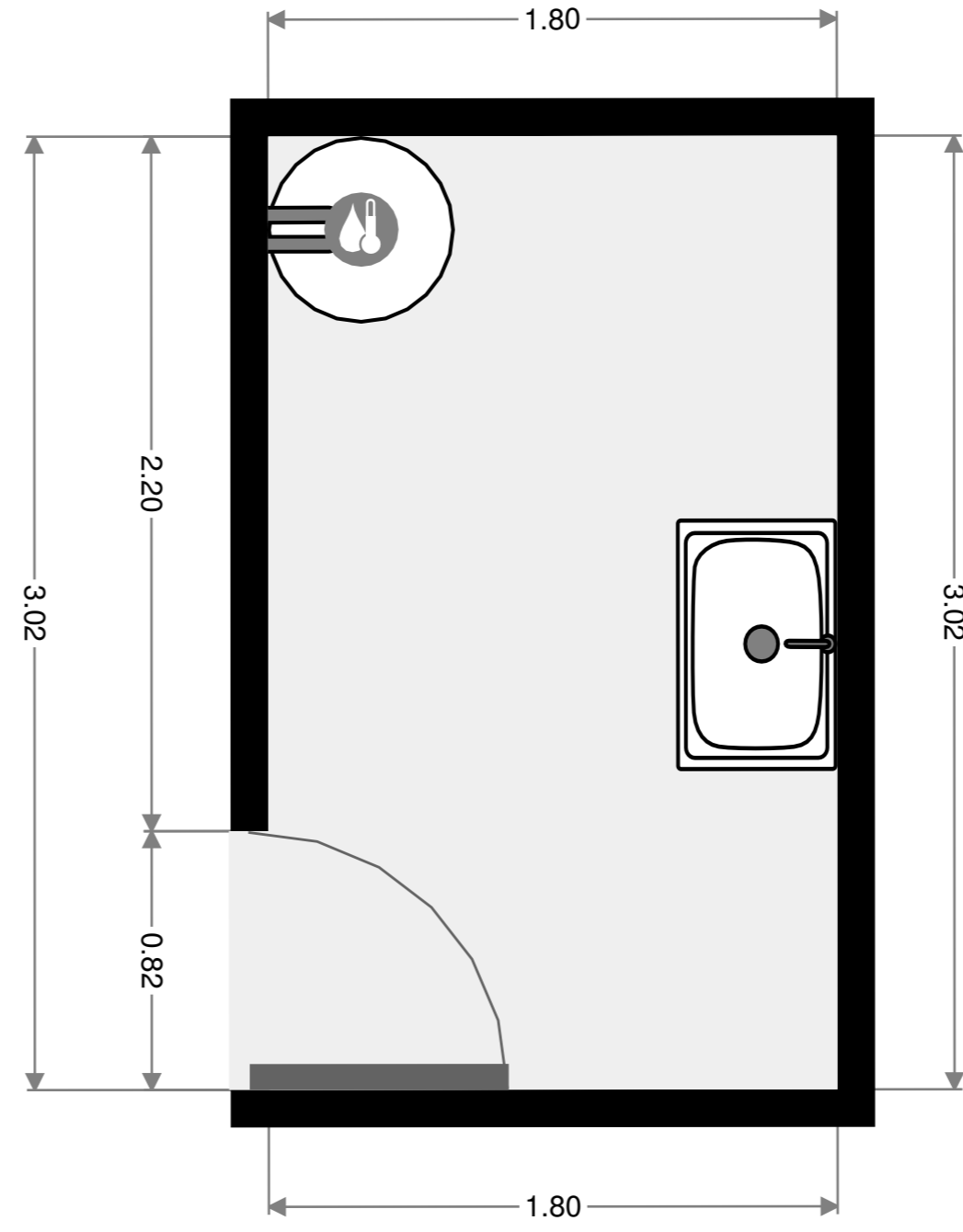
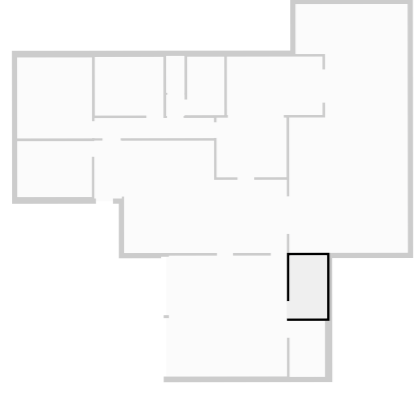

Other

Width: 1.70 m
 Length: 2.70 m
 Area: 4.58 m²
 Perimeter: 8.79 m

