

13 Lace Flower Court

SUBMITTED BY

Ray White Rockhampton Casey
stockers@cqoz.com

CREATED ON

2021-11-18

Floors

1

▼ Ground Floor



FLOORS: 1

▼ Bedroom Ground Floor

WIDTH: 3.13 m • LENGTH: 3.73 m
AREA: 10.89 m² • PERIMETER: 13.72 m

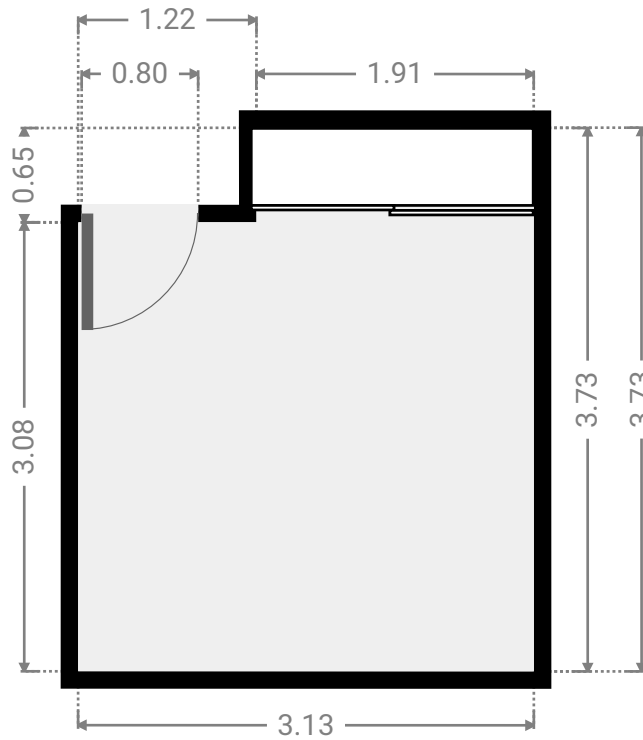
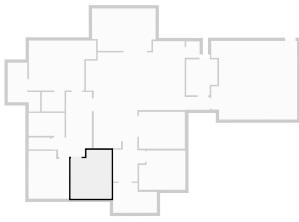

▼ Other Ground Floor

WIDTH: 3.35 m • LENGTH: 2.30 m
AREA: 6.67 m² • PERIMETER: 11.30 m

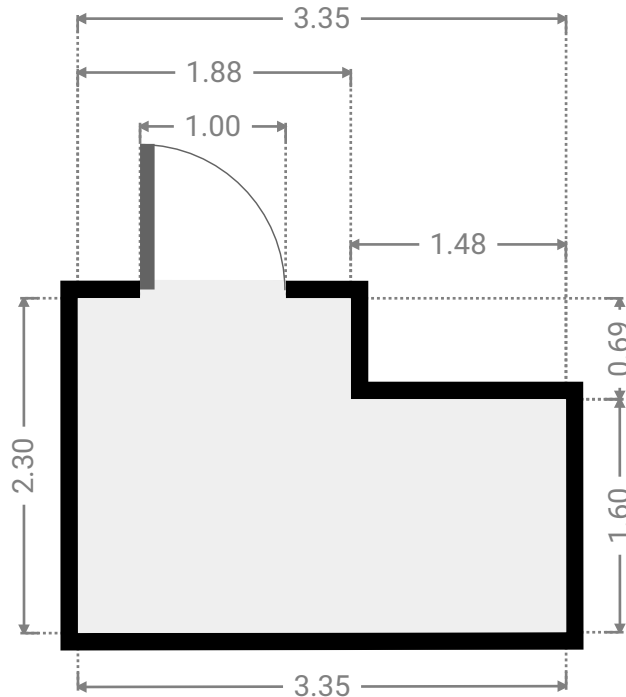
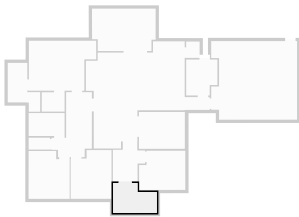

13 Lace Flower Court

FLOORS: 1



▼ Closet Ground Floor

WIDTH: 4.88 m • LENGTH: 3.25 m
AREA: 15.17 m² • PERIMETER: 16.25 m

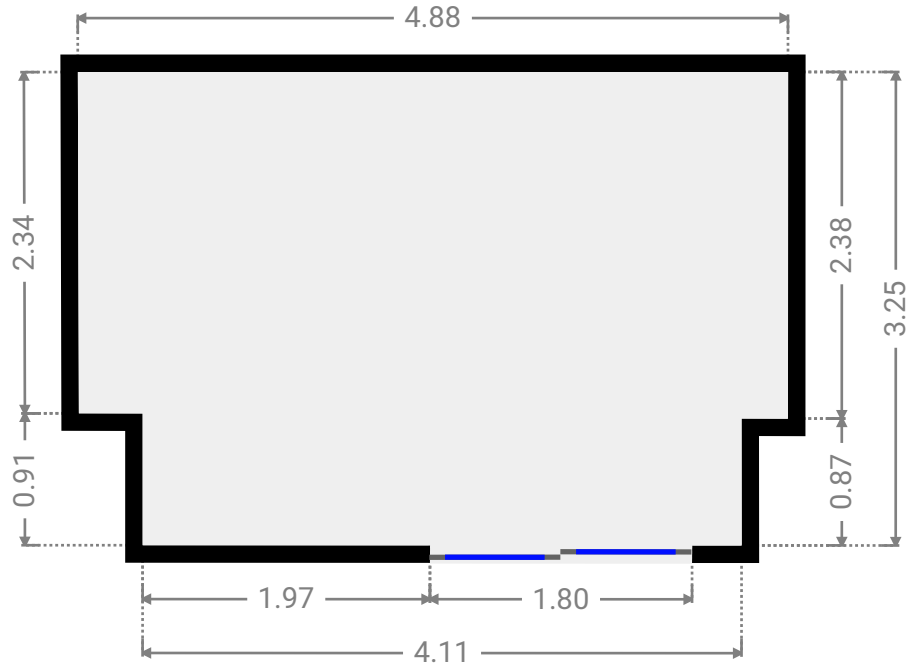
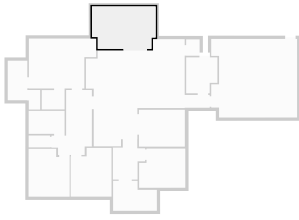

▼ Closet Ground Floor

WIDTH: 1.75 m • LENGTH: 1.48 m
AREA: 2.59 m² • PERIMETER: 6.46 m

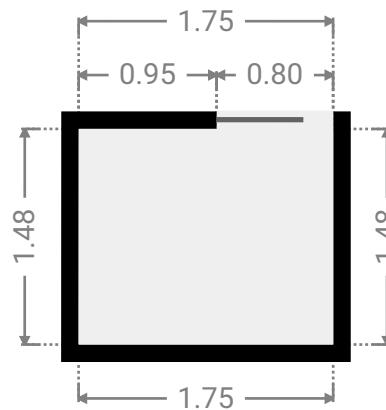
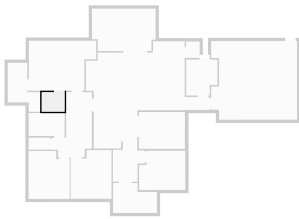

FLOORS: 1

▼ Toilet Ground Floor

WIDTH: 0.87 m • LENGTH: 1.50 m
AREA: 1.30 m² • PERIMETER: 4.74 m

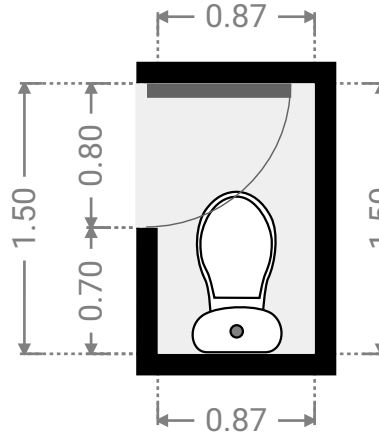
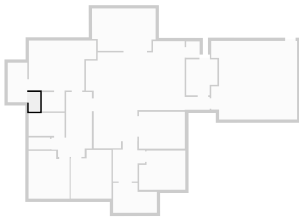

▼ Bathroom Ground Floor

WIDTH: 1.50 m • LENGTH: 3.03 m
AREA: 4.55 m² • PERIMETER: 9.06 m

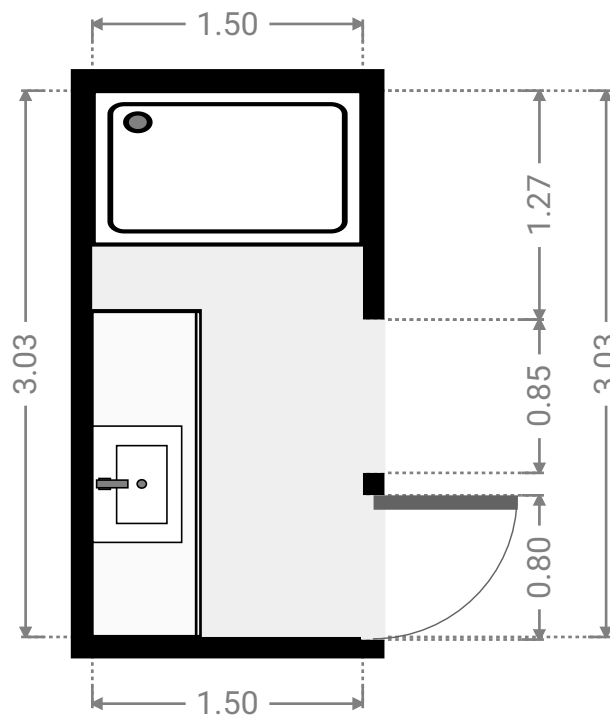
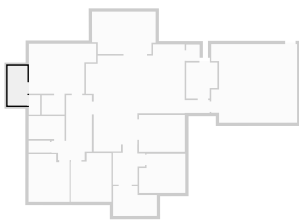

FLOORS: 1

▼ **Master Bedroom**
Ground Floor

WIDTH: 5.16 m • LENGTH: 3.83 m
AREA: 17.55 m² • PERIMETER: 17.96 m

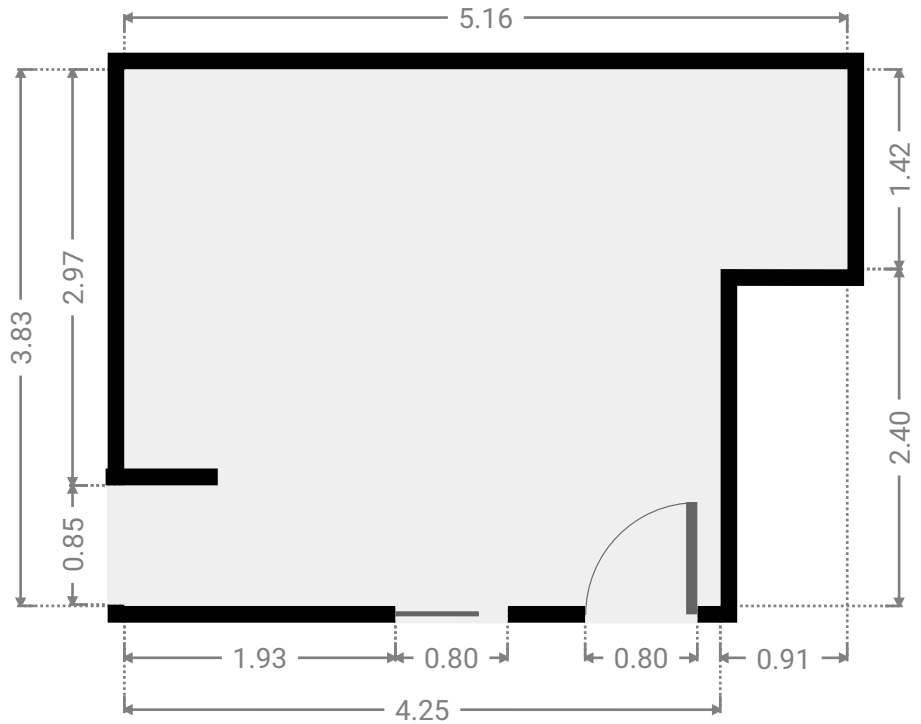
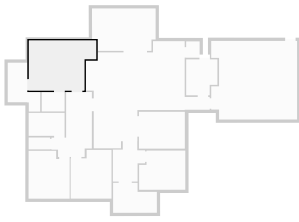

▼ **Bathroom**
Ground Floor

WIDTH: 2.75 m • LENGTH: 1.76 m
AREA: 4.84 m² • PERIMETER: 9.02 m

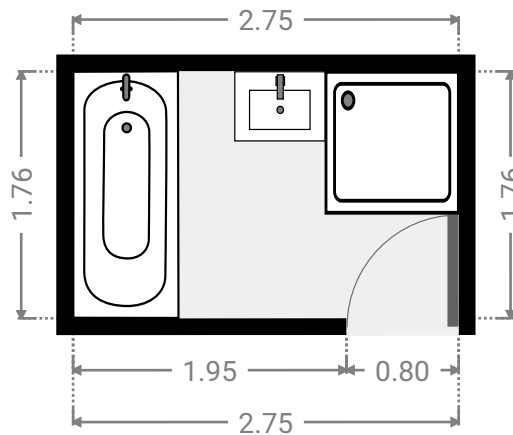
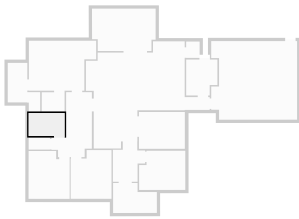

FLOORS: 1

▼ **Toilet**
Ground Floor

WIDTH: 1.63 m • LENGTH: 0.91 m
AREA: 1.48 m² • PERIMETER: 5.08 m

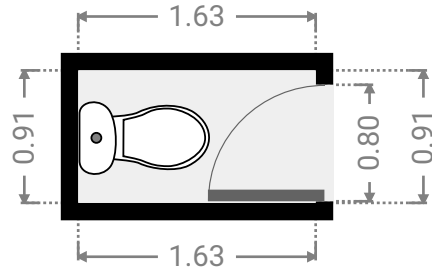
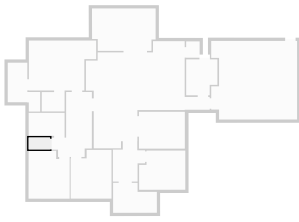

▼ **Bedroom**
Ground Floor

WIDTH: 3.15 m • LENGTH: 3.67 m
AREA: 10.89 m² • PERIMETER: 13.63 m

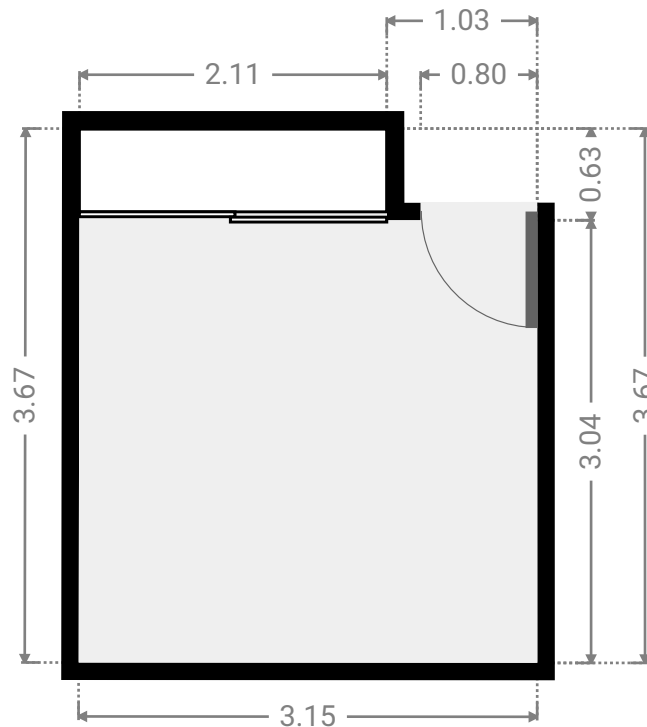
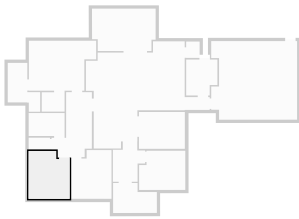

FLOORS: 1

▼ **Hall**
Ground Floor

WIDTH: 2.47 m • LENGTH: 2.97 m
AREA: 5.78 m² • PERIMETER: 10.88 m

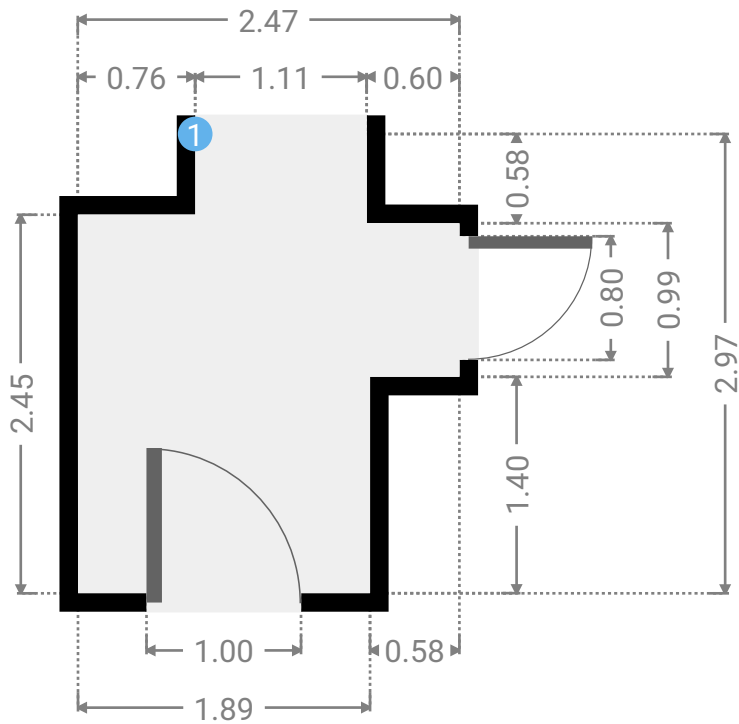
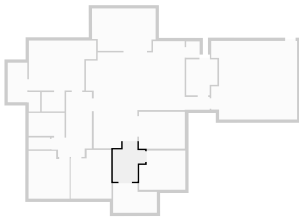

▼ **Hall/Ground Floor**

1 **OPENING**

Height
0.00 m



13 Lace Flower Court

FLOORS: 1



▼ Hall Ground Floor

WIDTH: 3.09 m • LENGTH: 4.98 m
AREA: 10.84 m² • PERIMETER: 16.14 m

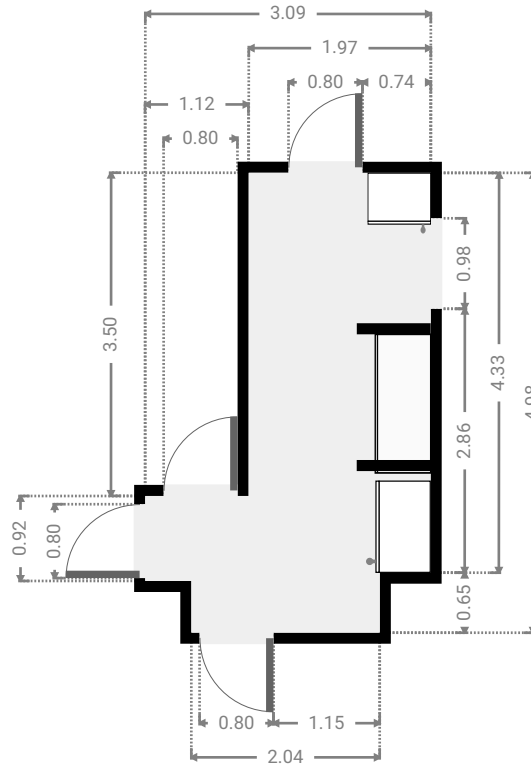
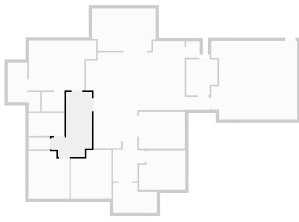

▼ Garage Ground Floor

WIDTH: 6.58 m • LENGTH: 6.03 m
AREA: 37.87 m² • PERIMETER: 26.41 m

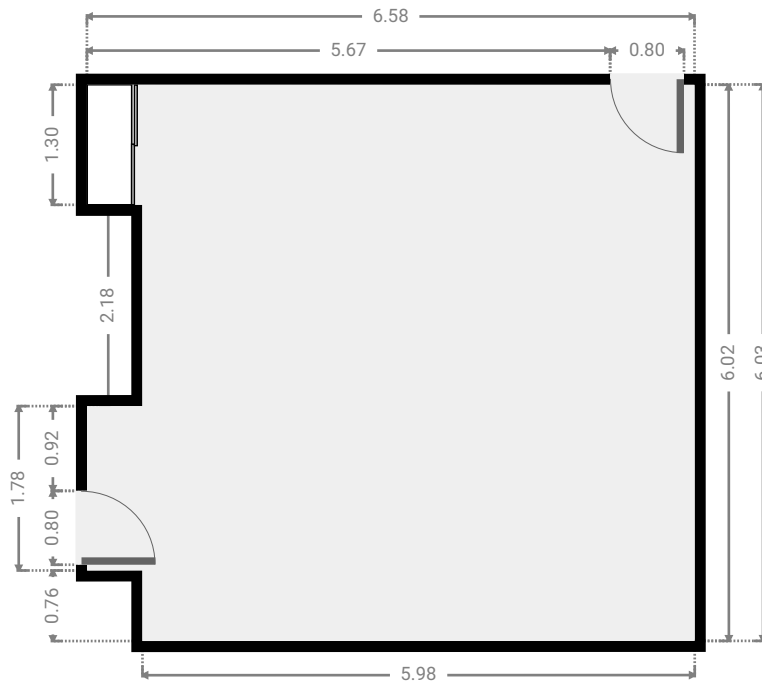
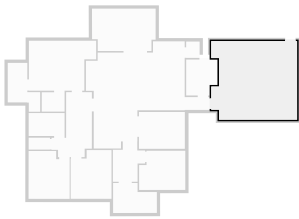

THIS FLOORPLAN IS PROVIDED WITHOUT WARRANTY OF ANY KIND. SENSOPIA DISCLAIMS ANY WARRANTY INCLUDING, WITHOUT LIMITATION, SATISFACTORY QUALITY OR ACCURACY OF DIMENSIONS.

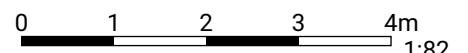

▼ Laundry Room Ground Floor

WIDTH: 2.39 m • LENGTH: 2.75 m
AREA: 6.10 m² • PERIMETER: 10.28 m

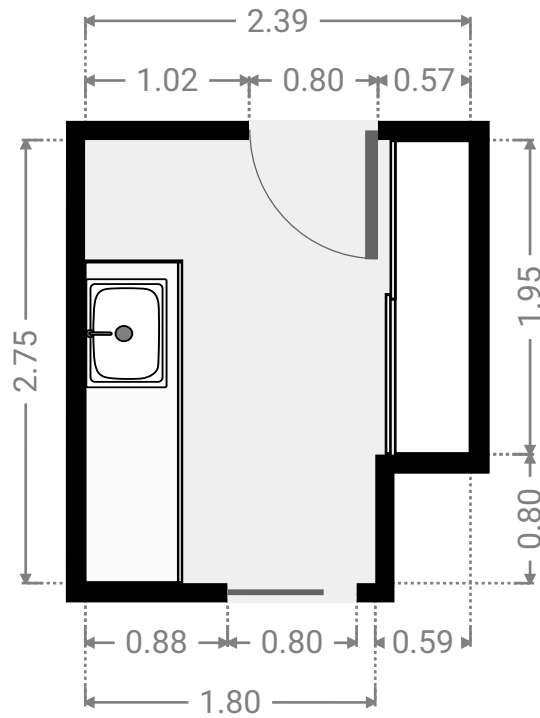
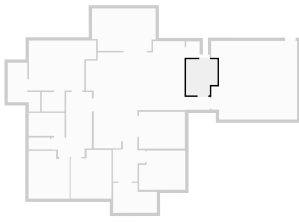

▼ Hall Ground Floor

WIDTH: 1.79 m • LENGTH: 0.98 m
AREA: 1.76 m² • PERIMETER: 5.55 m

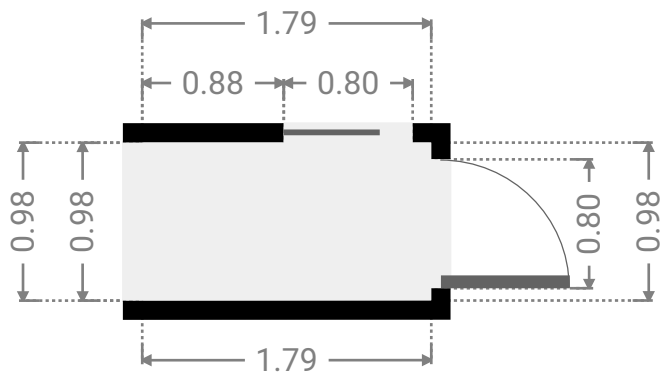
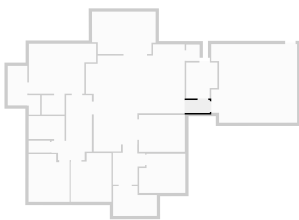

FLOORS: 1

▼ Closet Ground Floor

WIDTH: 1.03 m • LENGTH: 1.25 m
AREA: 1.29 m² • PERIMETER: 4.56 m

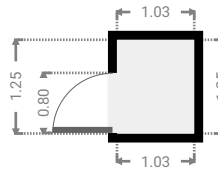
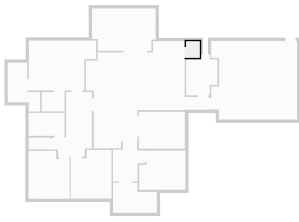

▼ Kitchen Ground Floor

WIDTH: 7.57 m • LENGTH: 8.21 m
AREA: 43.22 m² • PERIMETER: 31.56 m

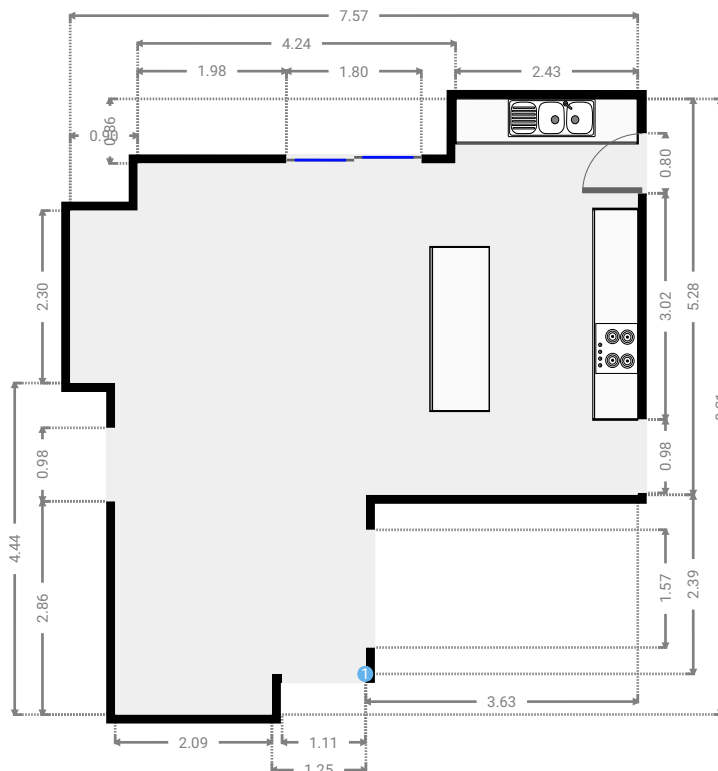
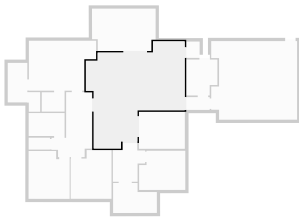

FLOORS: 1

▼ **Living Room**
Ground Floor

WIDTH: 3.52 m • LENGTH: 2.82 m
AREA: 9.93 m² • PERIMETER: 12.68 m

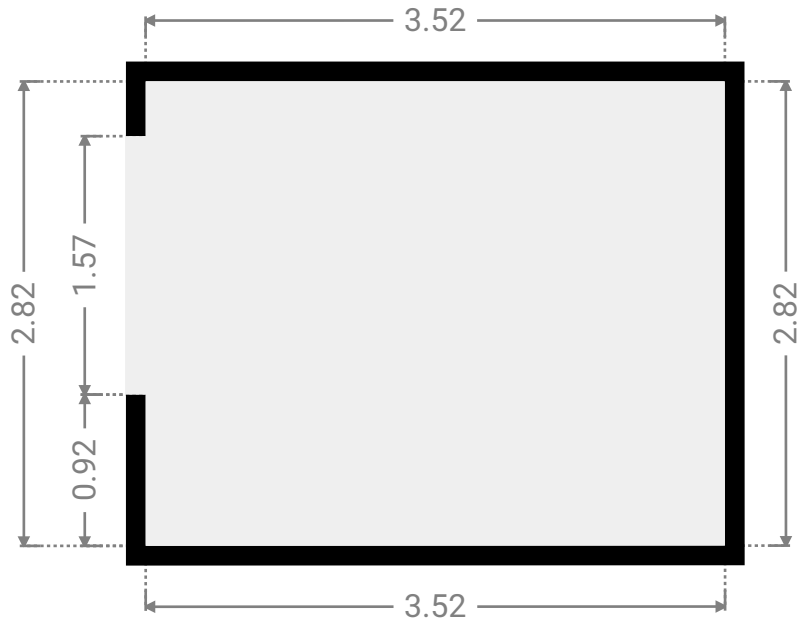
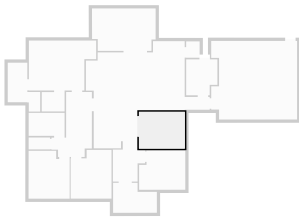

▼ **Bedroom**
Ground Floor

WIDTH: 3.54 m • LENGTH: 3.00 m
AREA: 10.00 m² • PERIMETER: 13.08 m

