

# 13 Bonderson Street

Created on  
2021-01-28

Floors  
1

▼ Ground Floor



▼ Living Room  
Ground Floor

WIDTH: 5.10 m • LENGTH: 3.42 m  
AREA: 17.44 m<sup>2</sup> • PERIMETER: 17.04 m

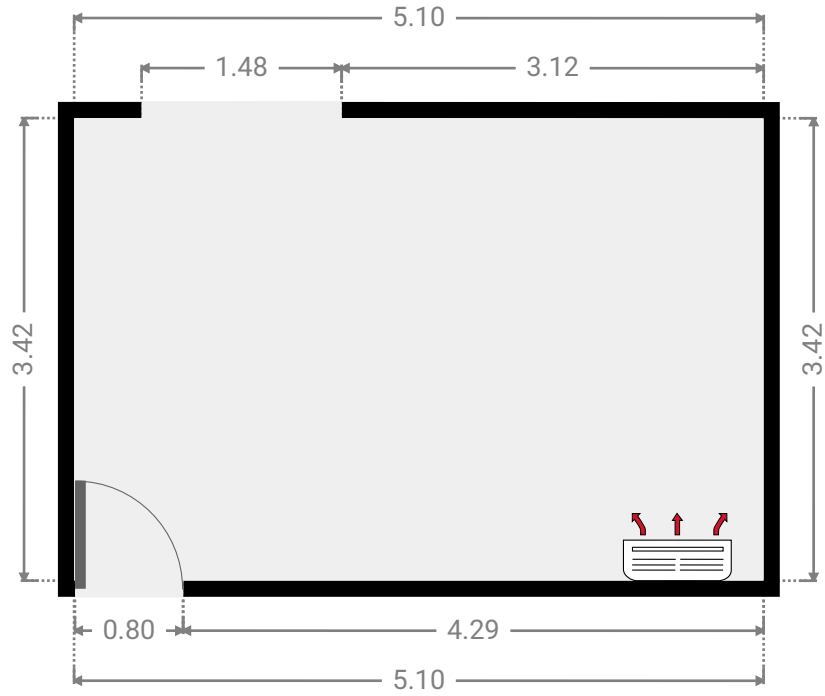
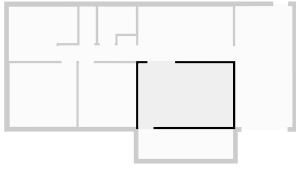

▼ Kitchen  
Ground Floor

WIDTH: 5.10 m • LENGTH: 2.93 m  
AREA: 14.94 m<sup>2</sup> • PERIMETER: 16.06 m

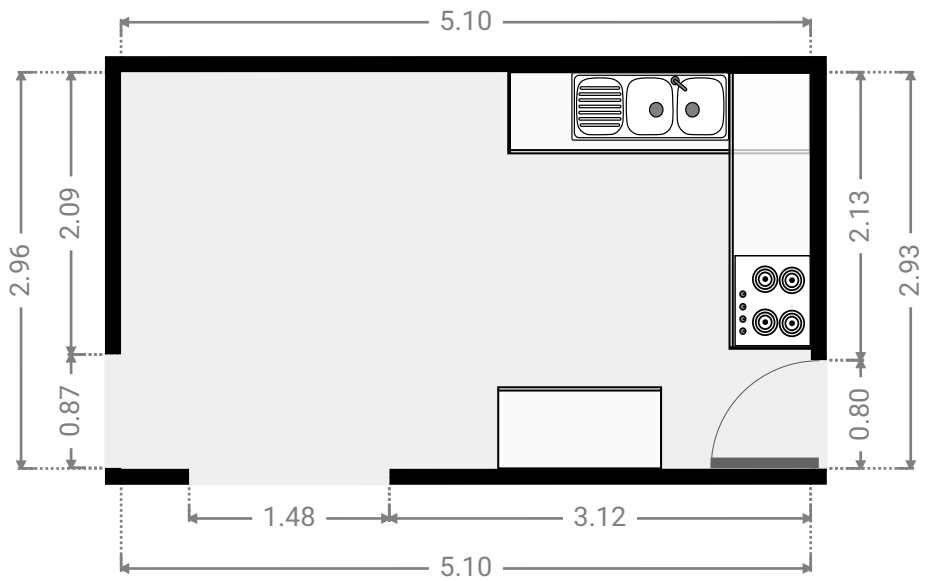
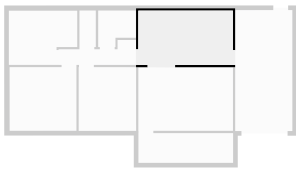

▼ **Hall**  
Ground Floor

WIDTH: 4.18 m • LENGTH: 1.34 m  
AREA: 4.02 m<sup>2</sup> • PERIMETER: 11.05 m

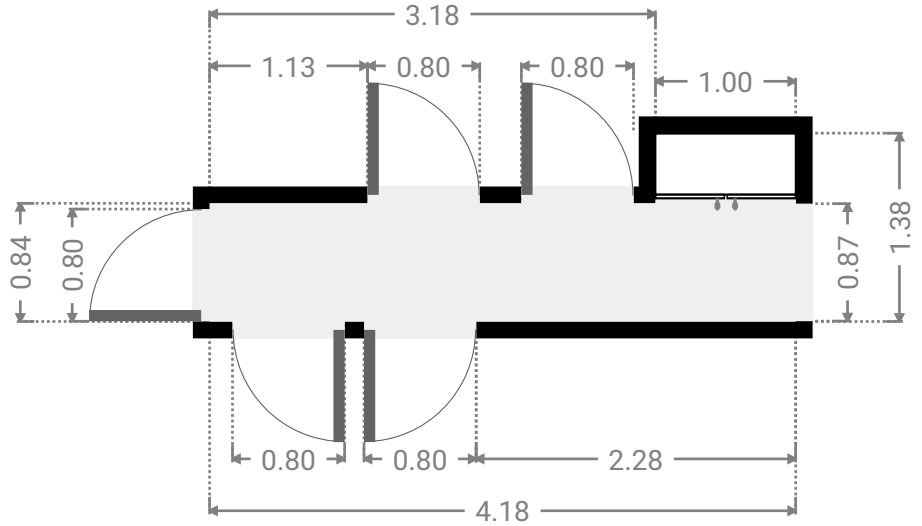
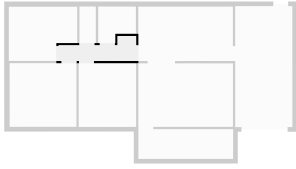

▼ **Bathroom**  
Ground Floor

WIDTH: 2.03 m • LENGTH: 1.97 m  
AREA: 3.44 m<sup>2</sup> • PERIMETER: 8.00 m

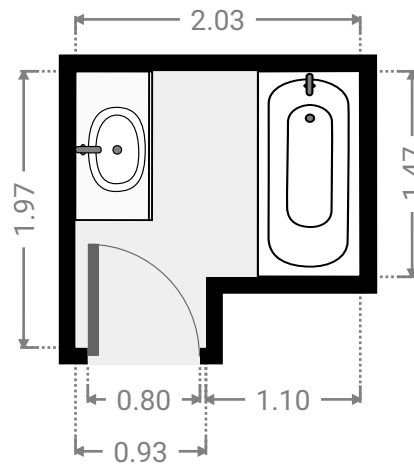
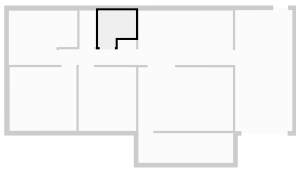

▼ **Vestibule**  
Ground Floor

WIDTH: 0.88 m • LENGTH: 1.97 m  
AREA: 1.73 m<sup>2</sup> • PERIMETER: 5.70 m

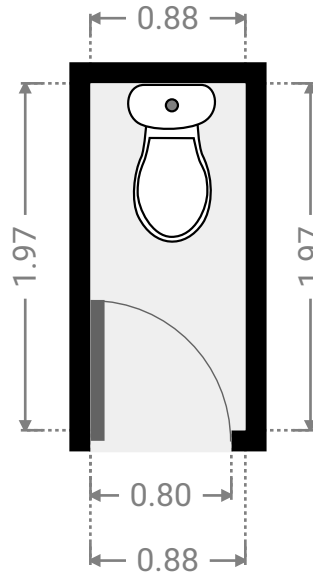
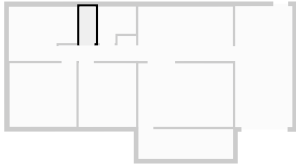

▼ **Bedroom**  
Ground Floor

WIDTH: 3.69 m • LENGTH: 2.92 m  
AREA: 9.69 m<sup>2</sup> • PERIMETER: 13.21 m

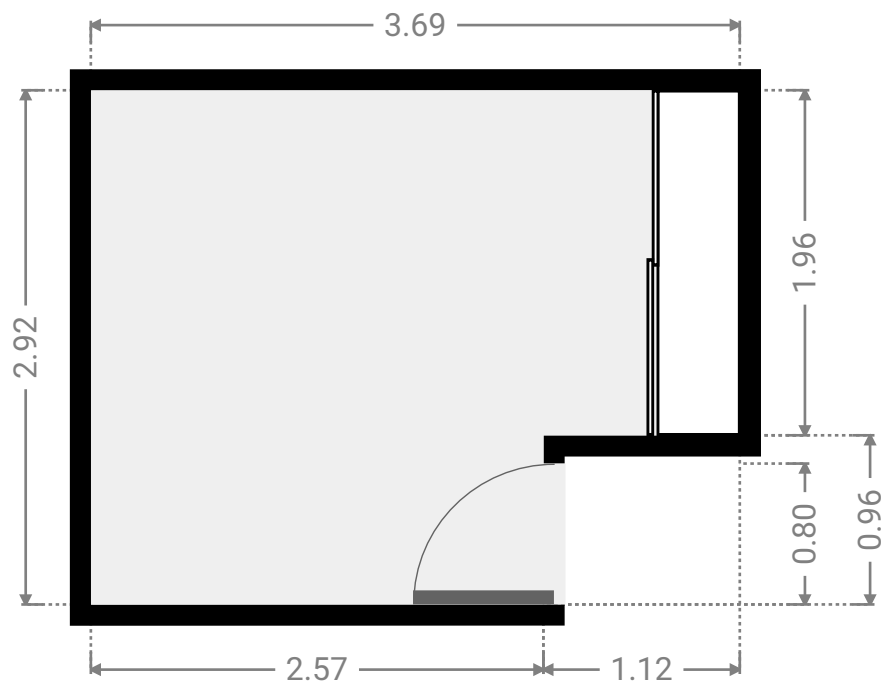
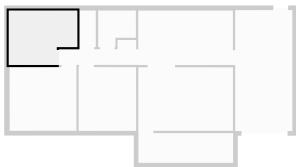

▼ **Bedroom**  
Ground Floor

WIDTH: 3.60 m • LENGTH: 3.43 m  
AREA: 12.35 m<sup>2</sup> • PERIMETER: 14.06 m

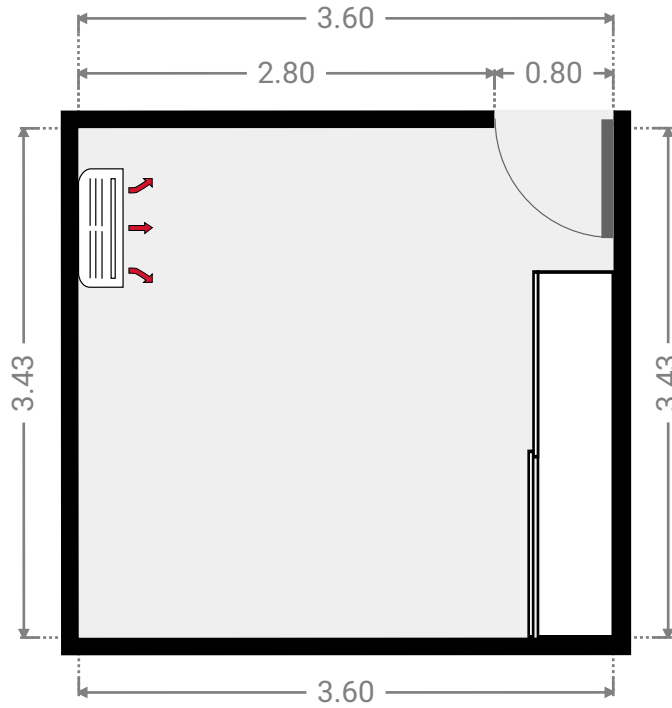
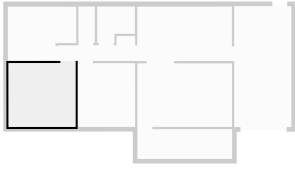

▼ **Bedroom**  
Ground Floor

WIDTH: 3.10 m • LENGTH: 3.44 m  
AREA: 10.64 m<sup>2</sup> • PERIMETER: 13.06 m

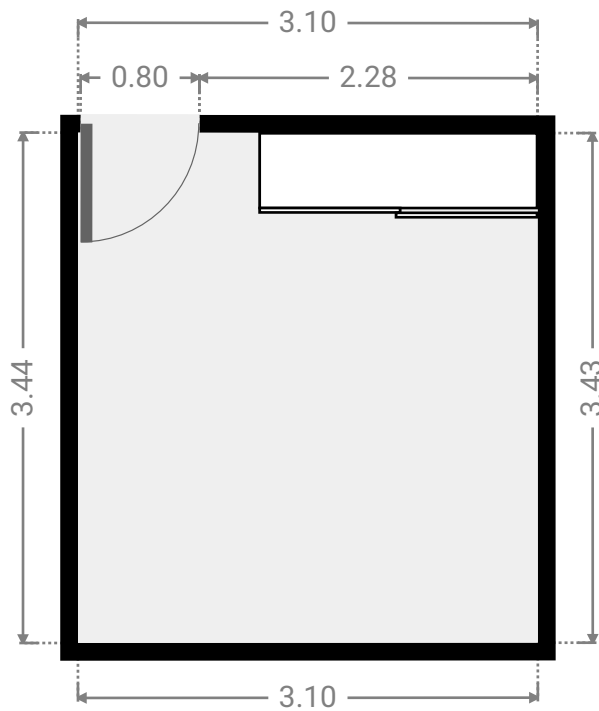
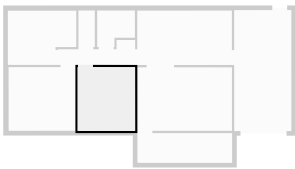

▼ **Garage**  
Ground Floor

WIDTH: 3.08 m • LENGTH: 6.52 m  
AREA: 20.08 m<sup>2</sup> • PERIMETER: 19.20 m

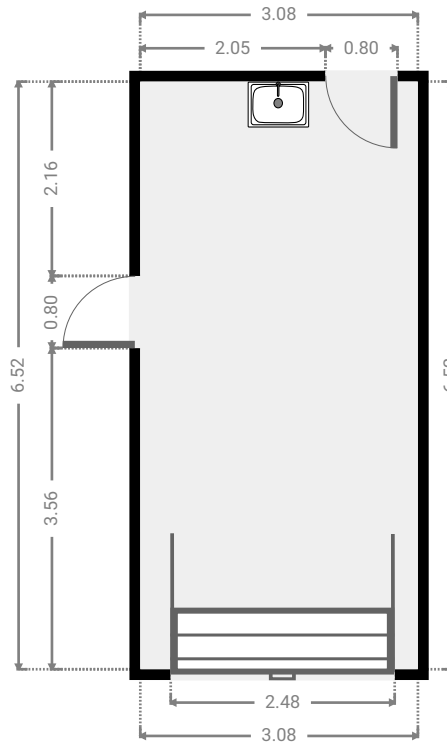
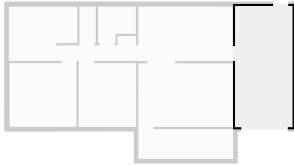

▼ **Other**  
Ground Floor

WIDTH: 5.10 m • LENGTH: 1.60 m  
AREA: 8.17 m<sup>2</sup> • PERIMETER: 13.41 m

