

13 Belbowrie Avenue

Ground Floor



THIS FLOORPLAN IS PROVIDED WITHOUT WARRANTY OF ANY KIND. SENSOPIA DISCLAIMS ANY WARRANTY INCLUDING, WITHOUT LIMITATION, SATISFACTORY QUALITY OR ACCURACY OF DIMENSIONS.



13 Belbowrie Avenue

Laundry Room

Width: 2.23 m
 Length: 3.59 m
 Area: 6.30 m²
 Perimeter: 11.65 m

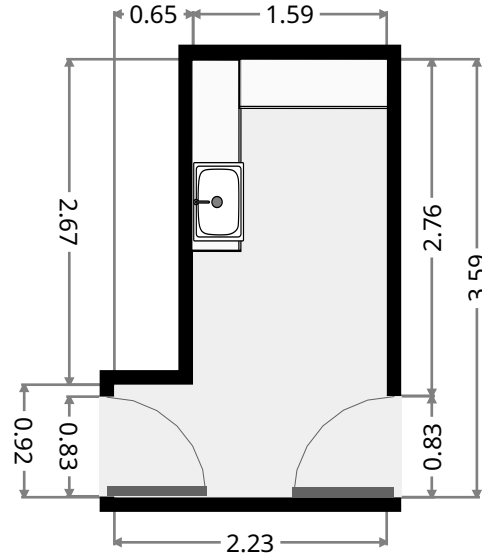
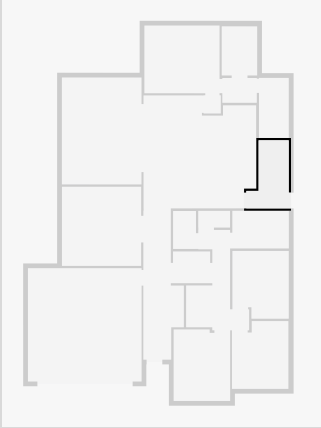

Outdoor Area

Width: 4.20 m
 Length: 5.64 m
 Area: 23.68 m²
 Perimeter: 19.68 m

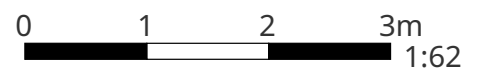
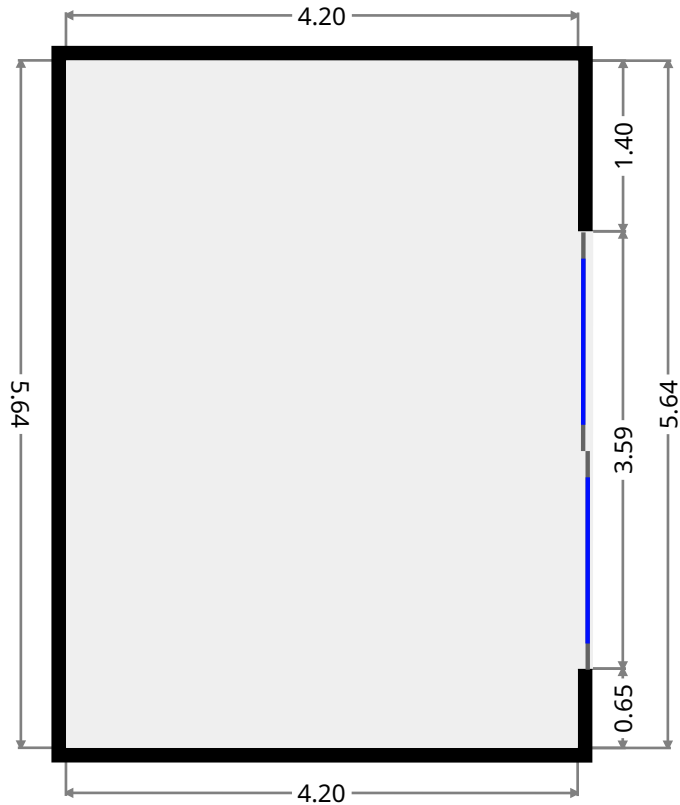
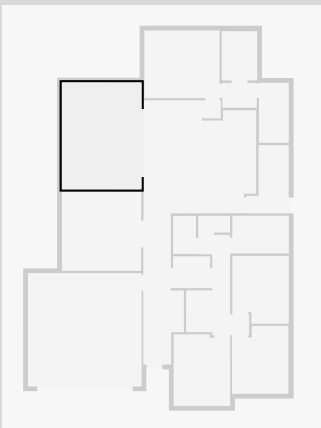

13 Belbowrie Avenue

Bedroom

Width: 2.98 m
Length: 3.77 m
Area: 11.05 m²
Perimeter: 13.50 m

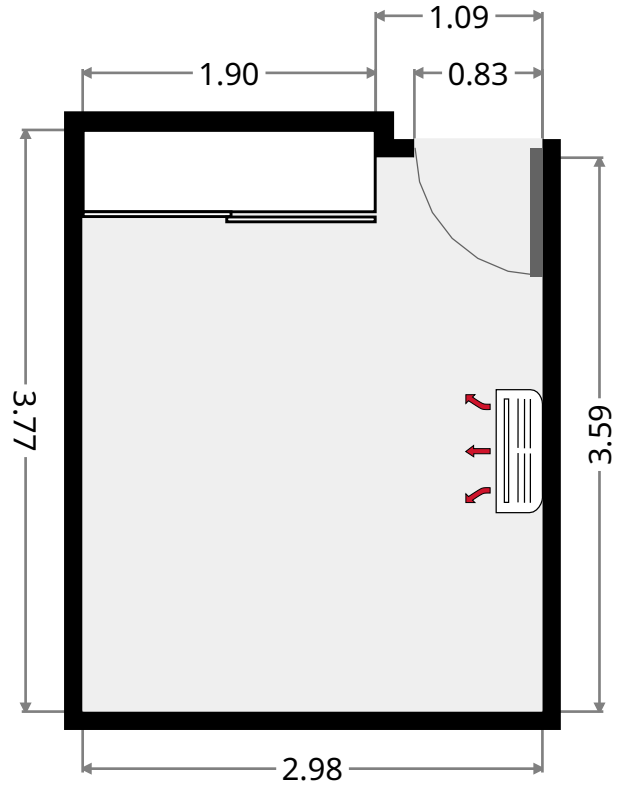
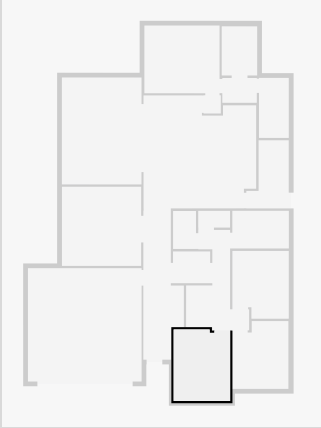

Bedroom

Width: 2.98 m
Length: 3.57 m
Area: 10.01 m²
Perimeter: 13.11 m

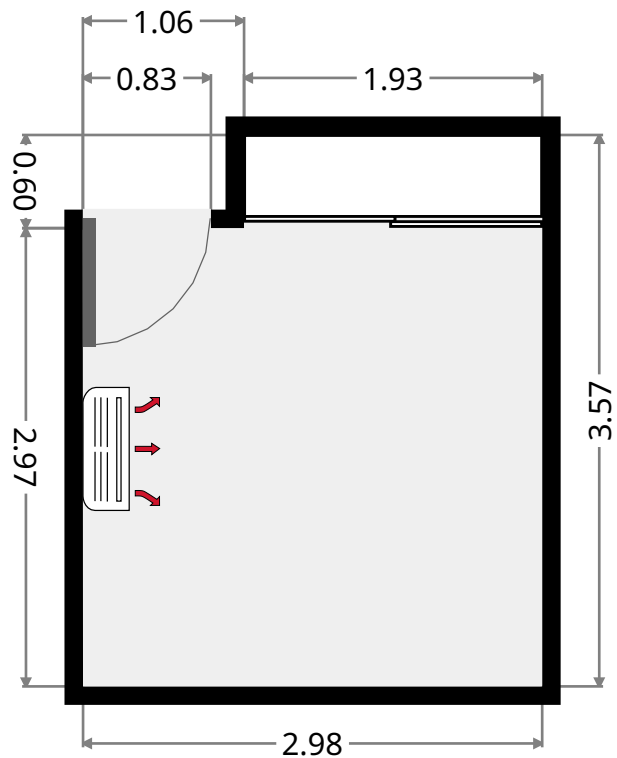
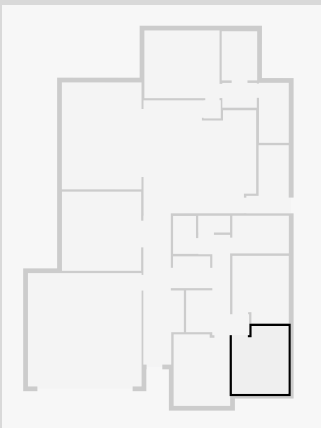

13 Belbowrie Avenue

Bedroom

Width: 2.97 m
Length: 3.58 m
Area: 10.02 m²
Perimeter: 13.10 m

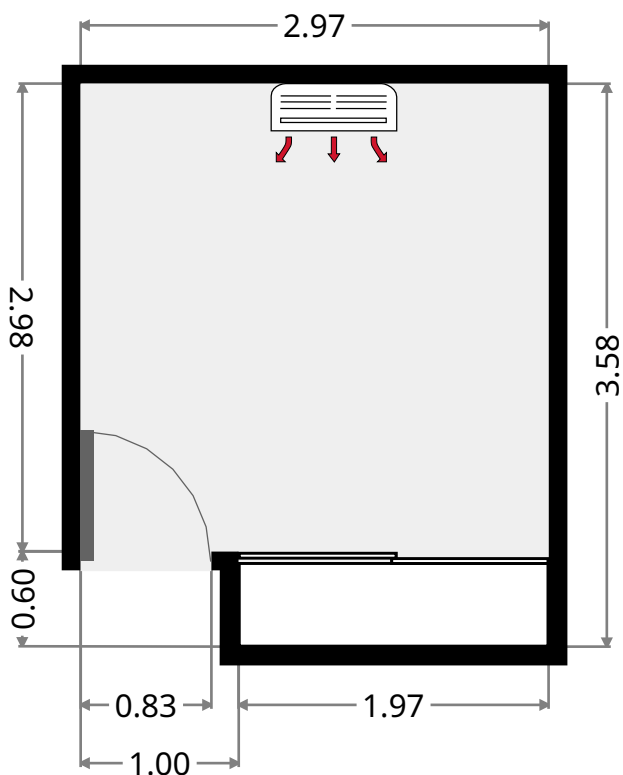
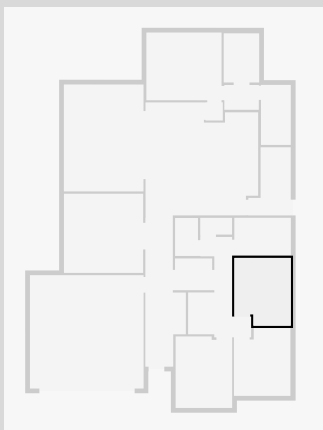

Bathroom

Width: 1.98 m
Length: 2.98 m
Area: 5.92 m²
Perimeter: 9.93 m

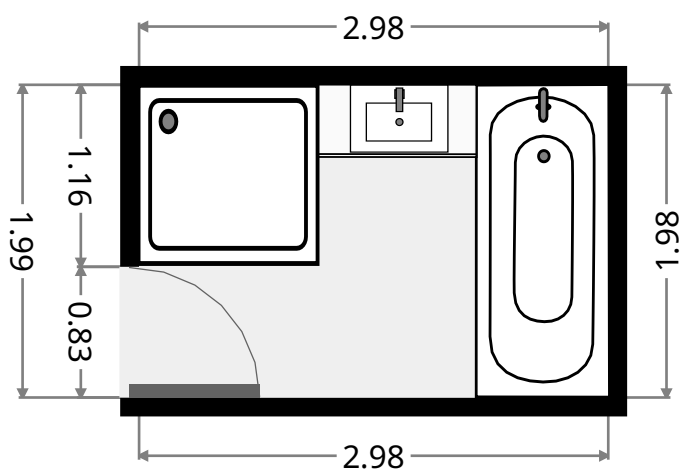
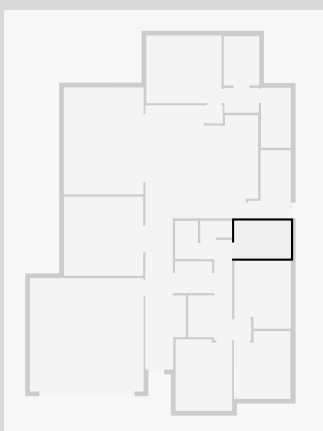

13 Belbowrie Avenue

Toilet

Width: 0.88 m
Length: 1.68 m
Area: 1.48 m²
Perimeter: 5.12 m

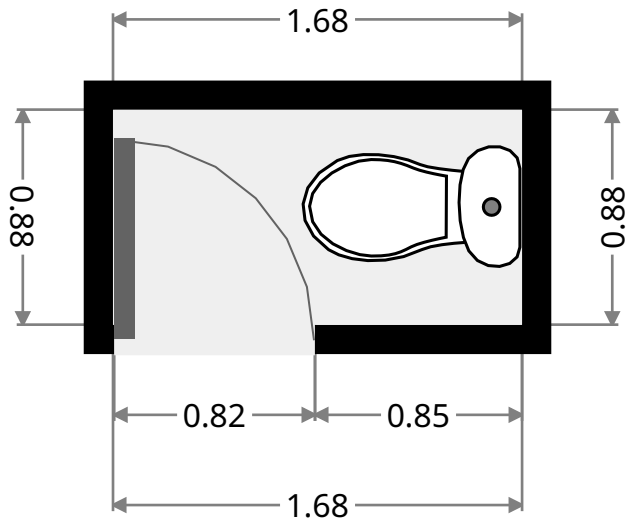
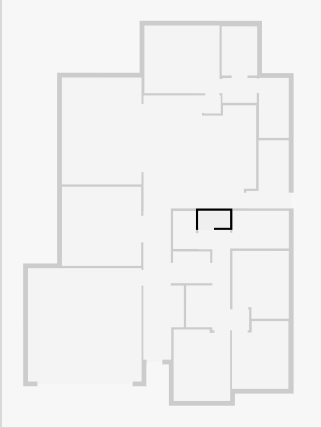

Closet

Width: 1.21 m
Length: 2.00 m
Area: 2.42 m²
Perimeter: 6.42 m

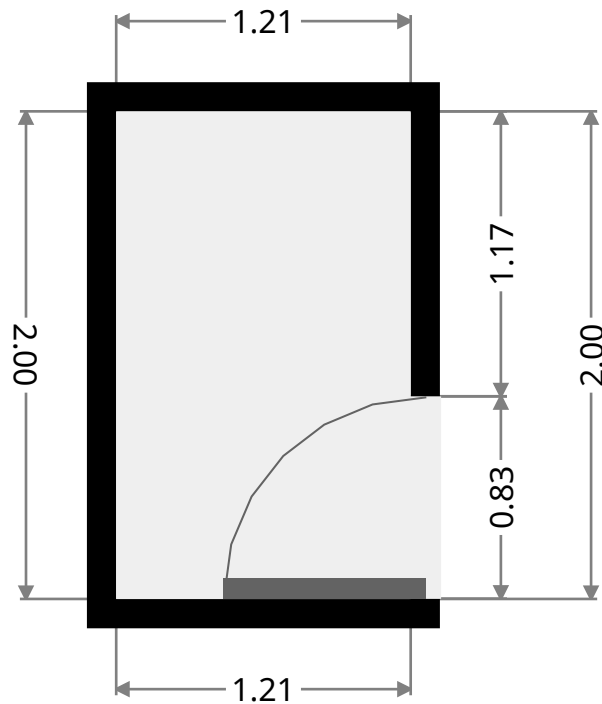
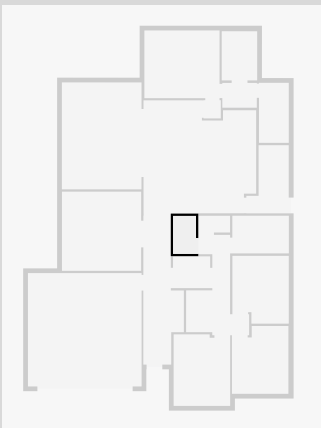

13 Belbowrie Avenue

Hall

Width: 3.32 m
 Length: 5.29 m
 Area: 9.87 m²
 Perimeter: 18.72 m

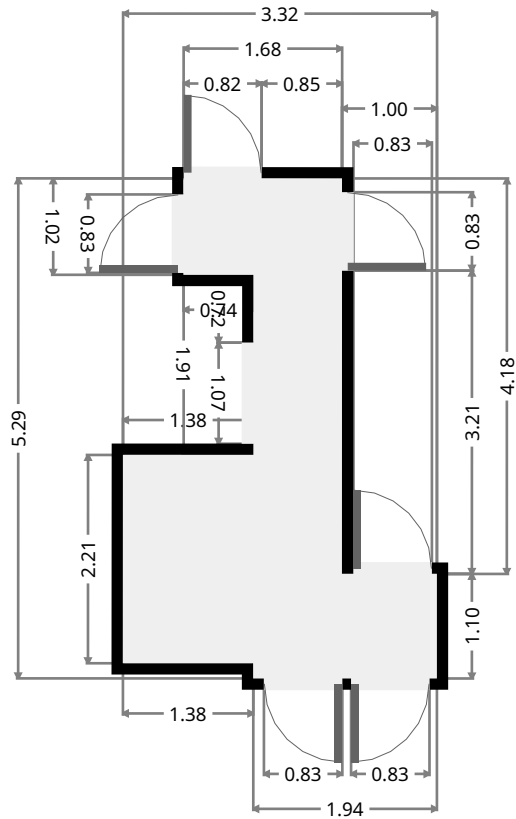
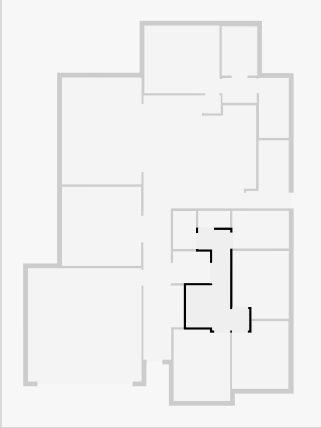

Hall

Width: 1.68 m
 Length: 1.96 m
 Area: 3.28 m²
 Perimeter: 7.27 m

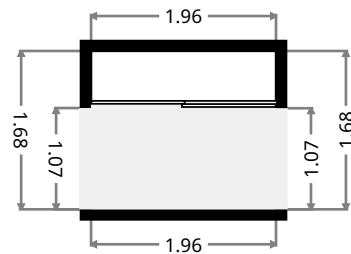
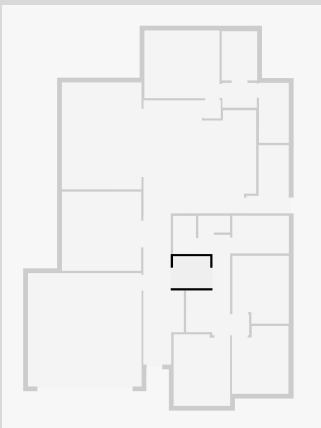

13 Belbowrie Avenue

Hall

Width: 2.14 m
Length: 7.86 m
Area: 12.93 m²
Perimeter: 19.98 m

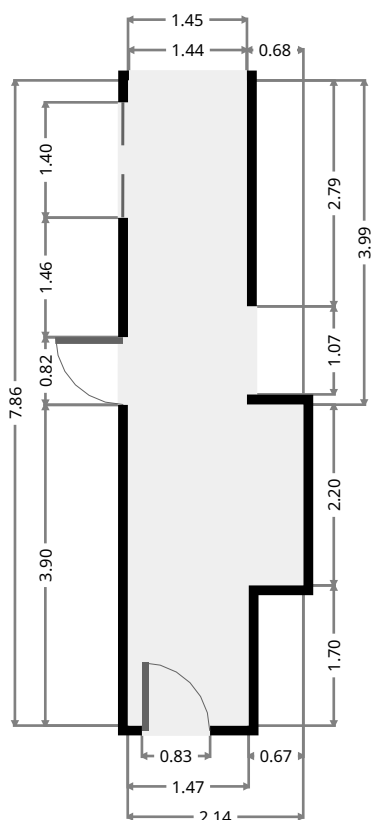
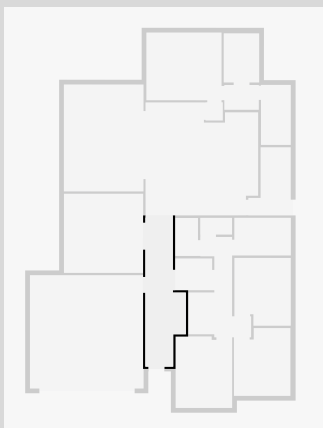

Ensuite

Width: 1.57 m
Length: 3.16 m
Area: 4.97 m²
Perimeter: 9.47 m

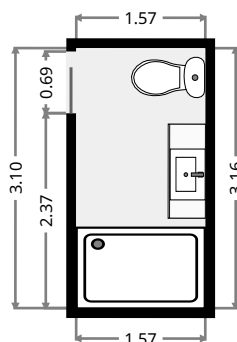
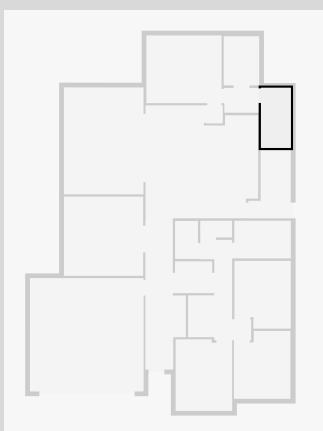

THIS FLOORPLAN IS PROVIDED WITHOUT WARRANTY OF ANY KIND. SENSOPIA DISCLAIMS ANY WARRANTY INCLUDING, WITHOUT LIMITATION, SATISFACTORY QUALITY OR ACCURACY OF DIMENSIONS.



13 Belbowrie Avenue

Closet

Width: 1.87 m
 Length: 2.58 m
 Area: 4.85 m²
 Perimeter: 8.92 m

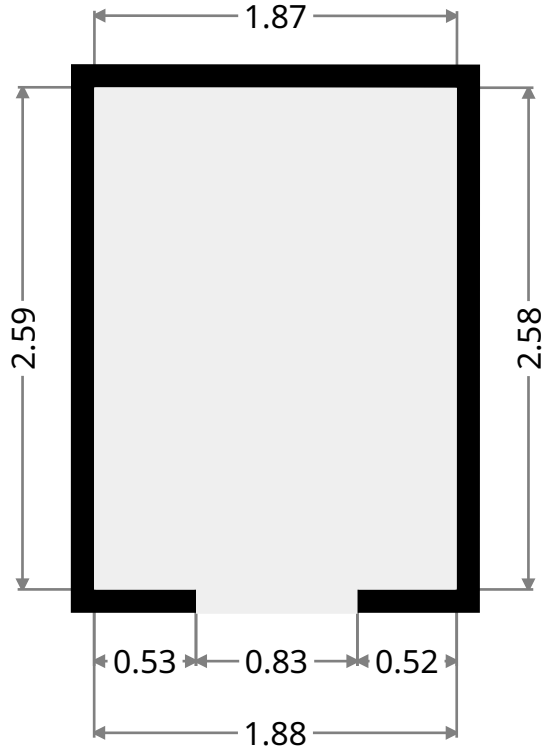
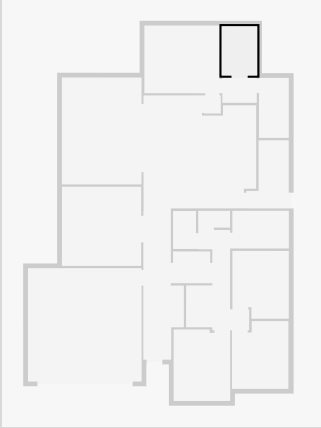

•
 Width: 1.30 m
 Length: 1.82 m
 Area: 2.38 m²
 Perimeter: 6.25 m

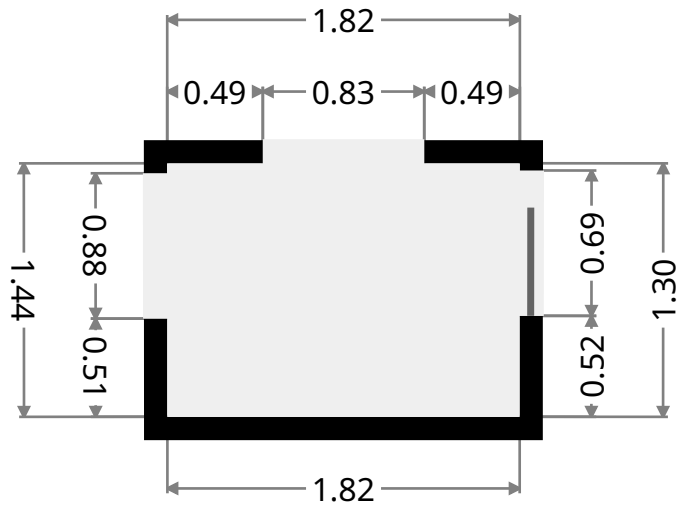
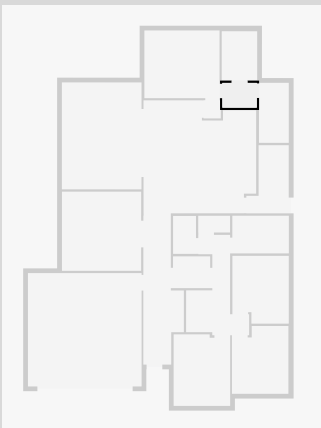

13 Belbowrie Avenue

Master Bedroom

Width: 3.58 m
 Length: 3.96 m
 Area: 14.16 m²
 Perimeter: 15.07 m

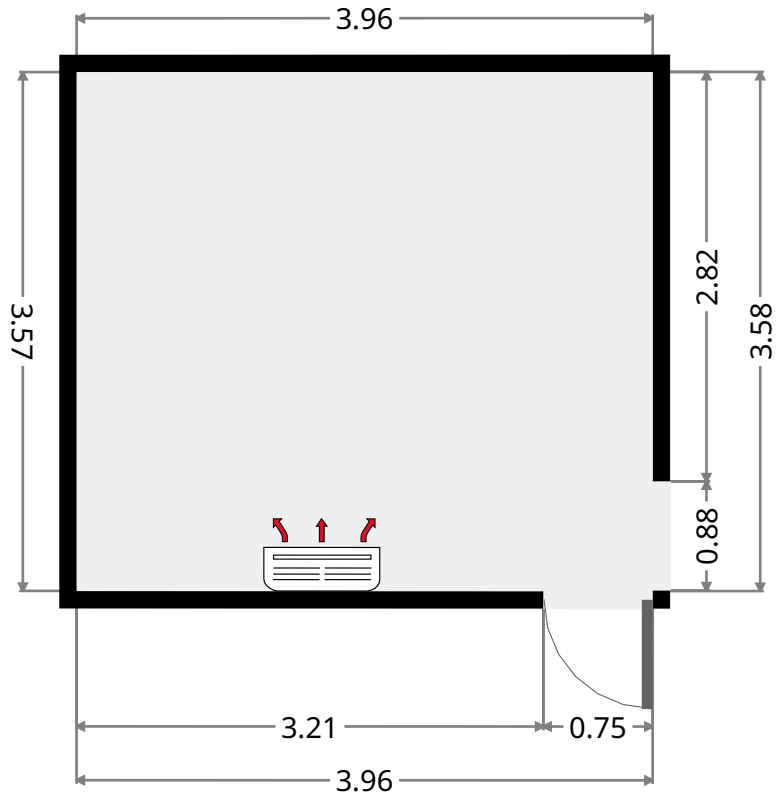
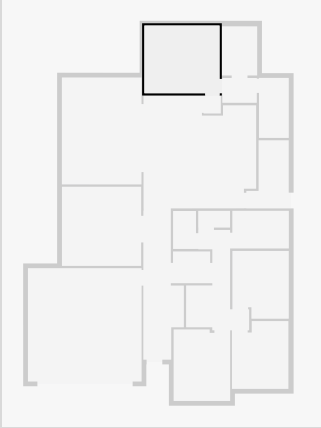

•
 Width: 0.91 m
 Length: 0.97 m
 Area: 0.87 m²
 Perimeter: 3.74 m

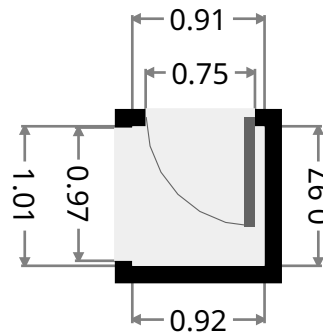
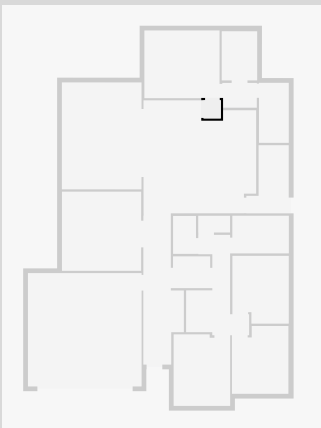

13 Belbowrie Avenue

Kitchen/Living/Dining

Width: 5.94 m
 Length: 5.97 m
 Area: 32.62 m²
 Perimeter: 24.88 m

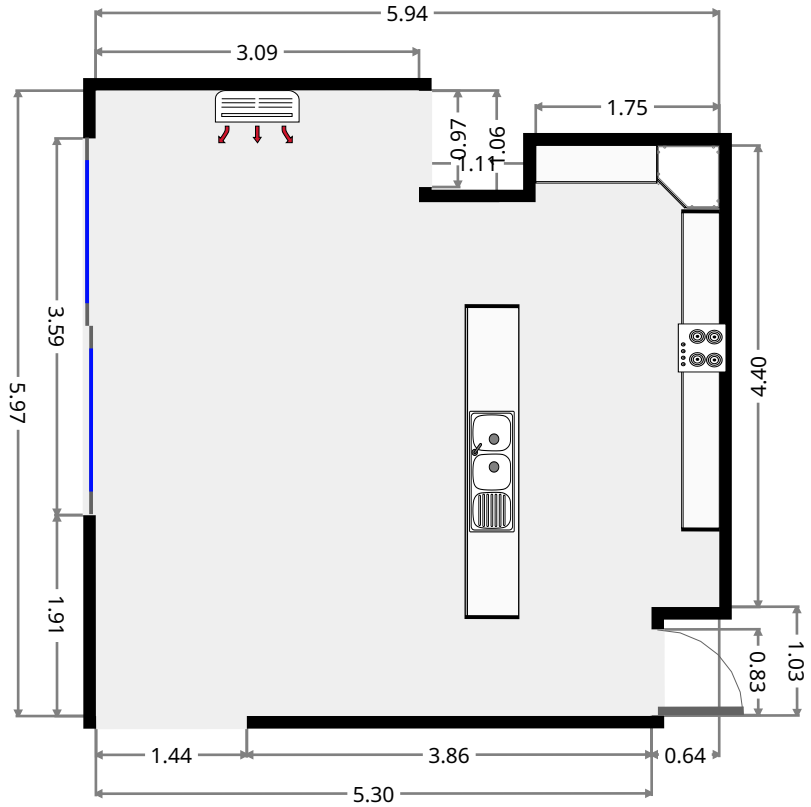
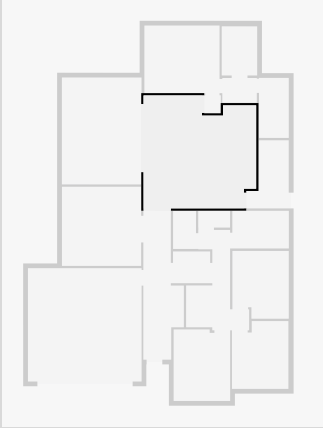

Media Room

Width: 4.18 m
 Length: 4.18 m
 Area: 17.45 m²
 Perimeter: 16.71 m

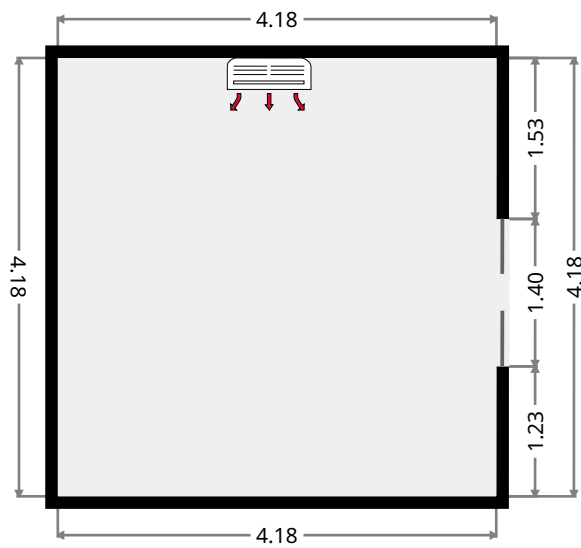
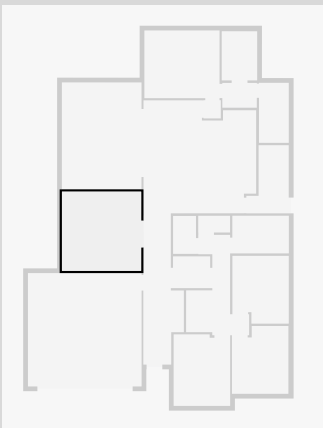

THIS FLOORPLAN IS PROVIDED WITHOUT WARRANTY OF ANY KIND. SENSOPIA DISCLAIMS ANY WARRANTY INCLUDING, WITHOUT LIMITATION, SATISFACTORY QUALITY OR ACCURACY OF DIMENSIONS.



13 Belbowrie Avenue

Garage

Width: 5.98 m
Length: 5.99 m
Area: 35.82 m²
Perimeter: 23.94 m

