

126 Menzies Street

SUBMITTED BY

Ray White Rockhampton Casey
stockers@cqoz.com

CREATED ON

2022-05-30

Floors

2

FLOORS: 2

▼ **Garage**
Ground Floor

WIDTH: 6.49 m • LENGTH: 6.80 m
AREA: 39.95 m² • PERIMETER: 26.57 m

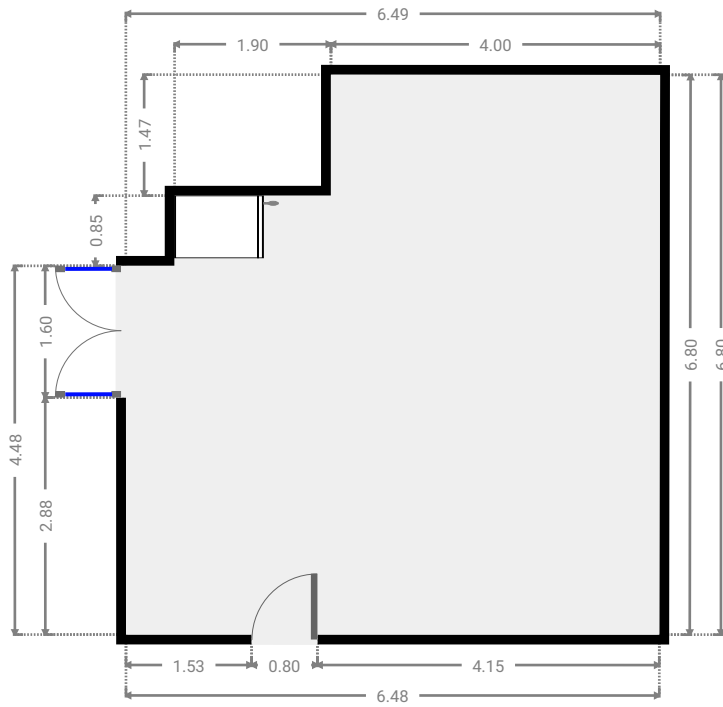
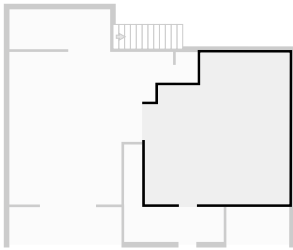

▼ **Garage**
Ground Floor

WIDTH: 7.35 m • LENGTH: 6.85 m
AREA: 40.64 m² • PERIMETER: 28.40 m

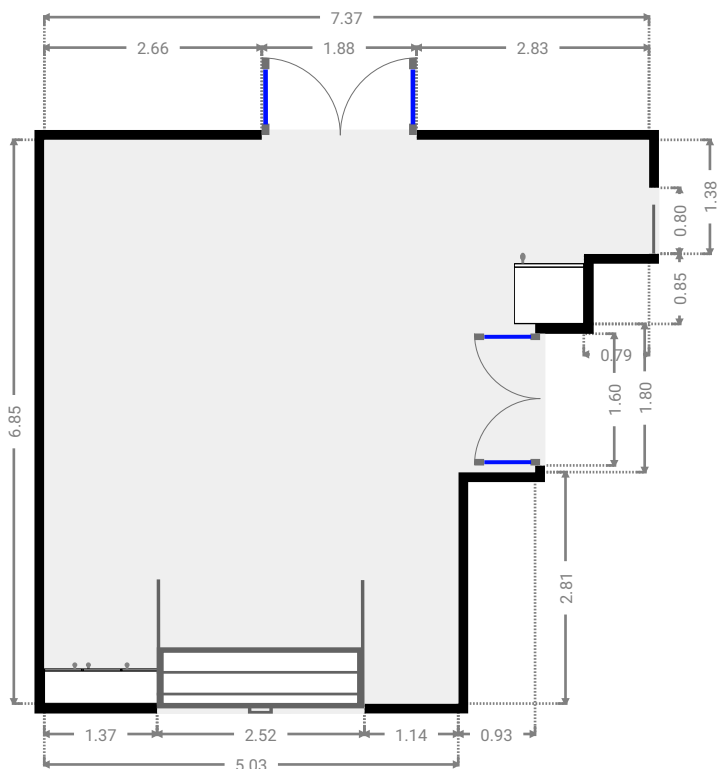
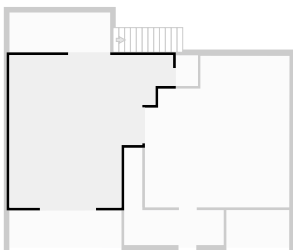

▼ Hall
Ground Floor

WIDTH: 4.47 m • LENGTH: 1.57 m
AREA: 7.02 m² • PERIMETER: 12.08 m

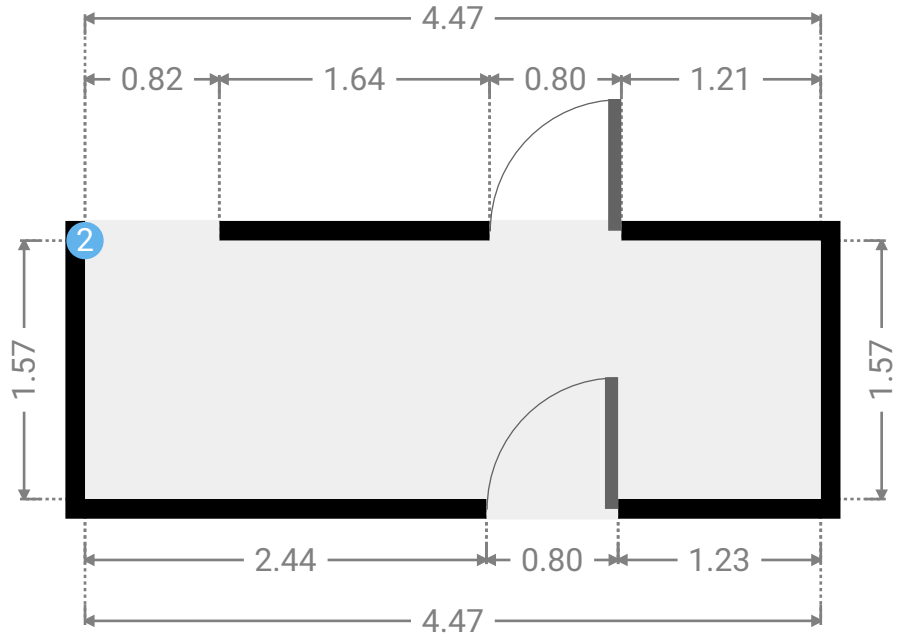
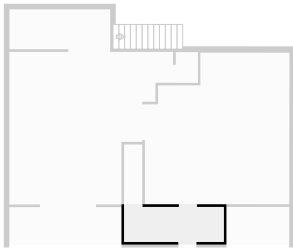

▼ Other
Ground Floor

WIDTH: 4.52 m • LENGTH: 1.79 m
AREA: 8.09 m² • PERIMETER: 12.62 m

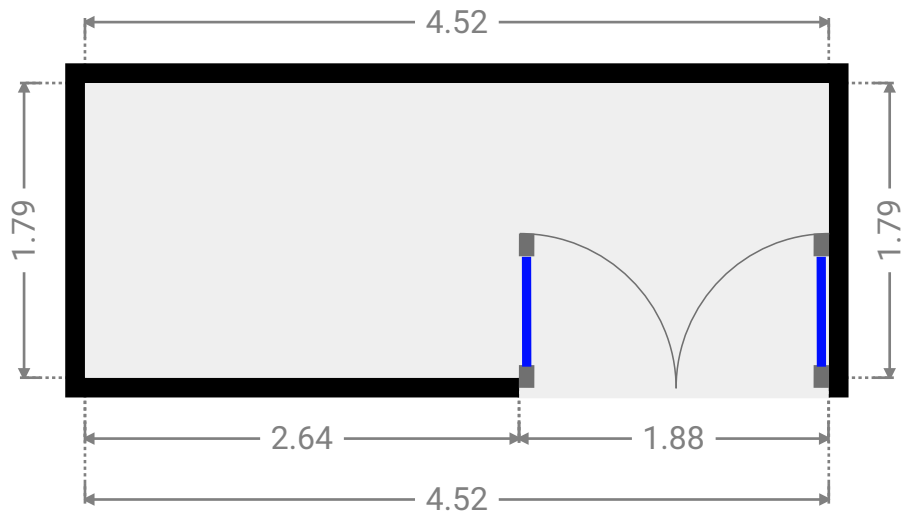
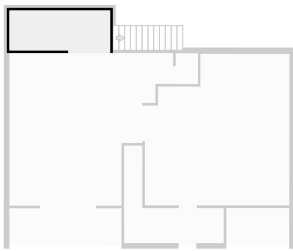

▼ **Other**
Ground Floor

WIDTH: 2.82 m • LENGTH: 1.57 m
AREA: 4.43 m² • PERIMETER: 8.78 m

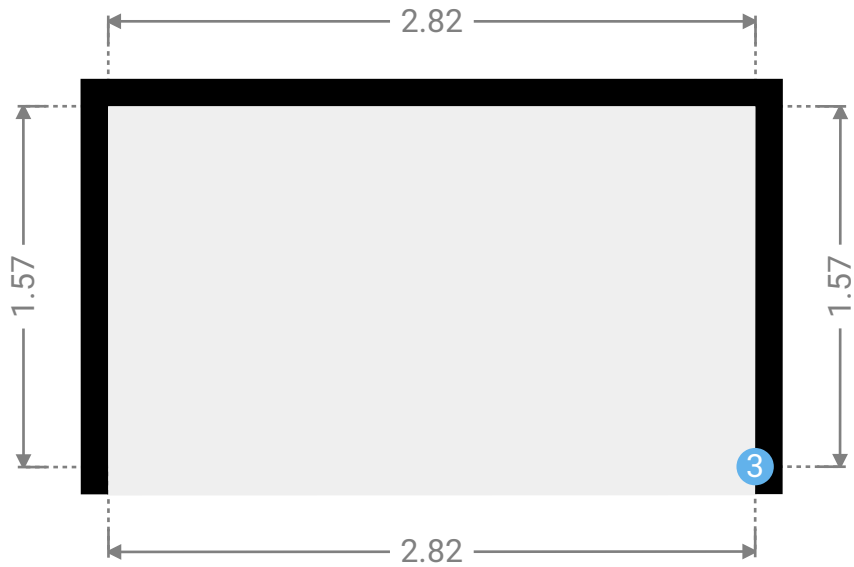
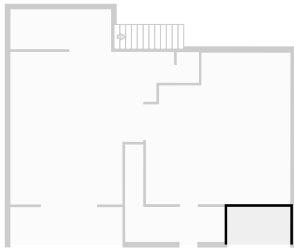

▼ **Other/**Ground Floor

3 OPENING

Height
0.00 m



▼ Other
Ground Floor

WIDTH: 5.03 m • LENGTH: 1.56 m
AREA: 7.86 m² • PERIMETER: 13.19 m

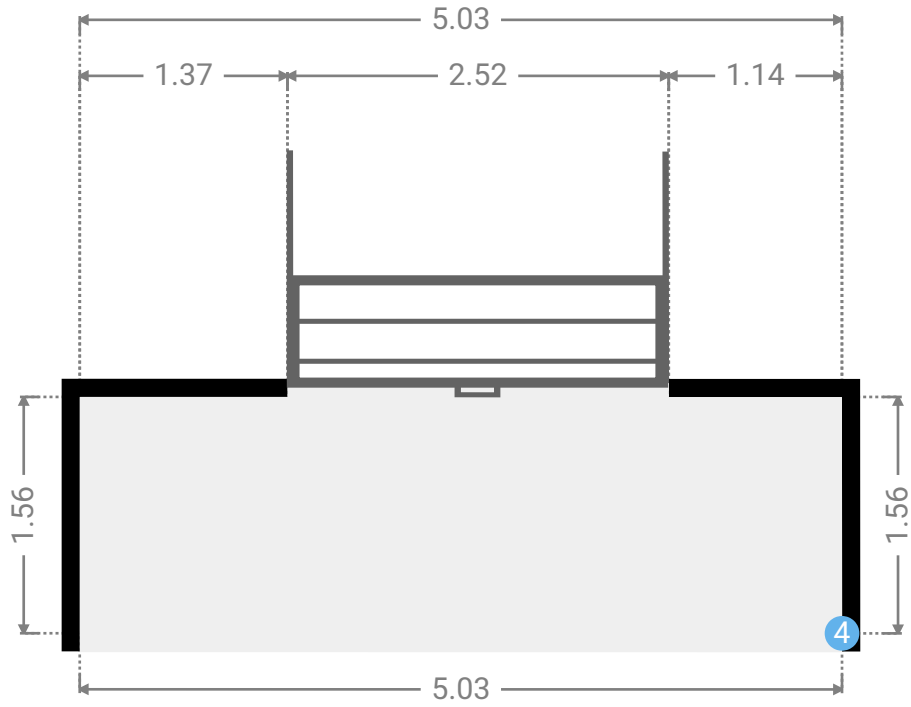
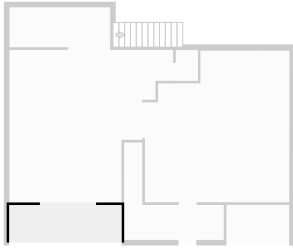

▼ Other/Ground Floor

4 OPENING

Height
0.00 m



▼ **Stairway**
Ground Floor

WIDTH: 0.83 m • LENGTH: 2.68 m
AREA: 2.18 m² • PERIMETER: 6.99 m

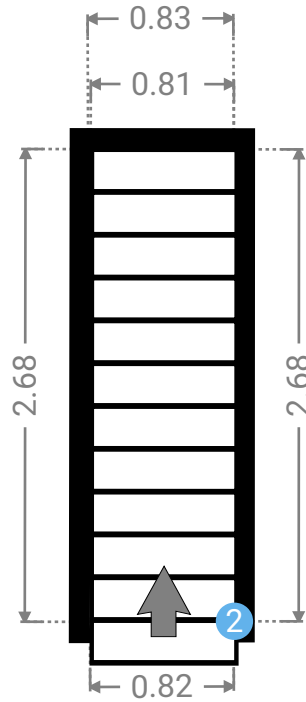
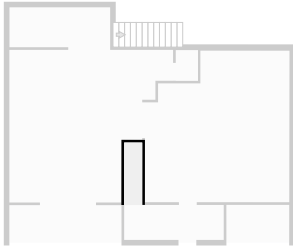

▼ **Stairway/Ground Floor**

2 OPENING

Height
0.00 m



▼ Toilet
Ground Floor

WIDTH: 1.00 m • LENGTH: 1.38 m
AREA: 1.38 m² • PERIMETER: 4.76 m

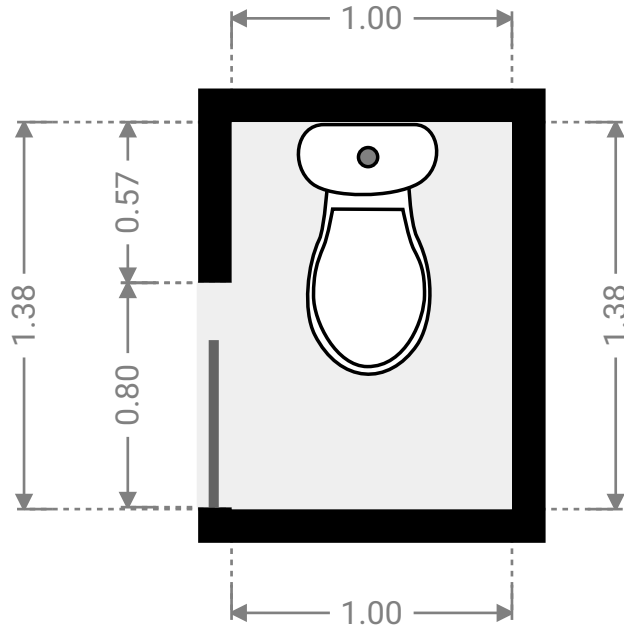
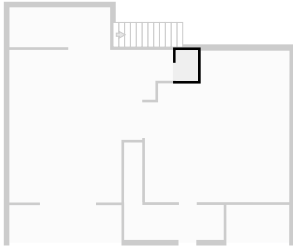

▼ 1st Floor

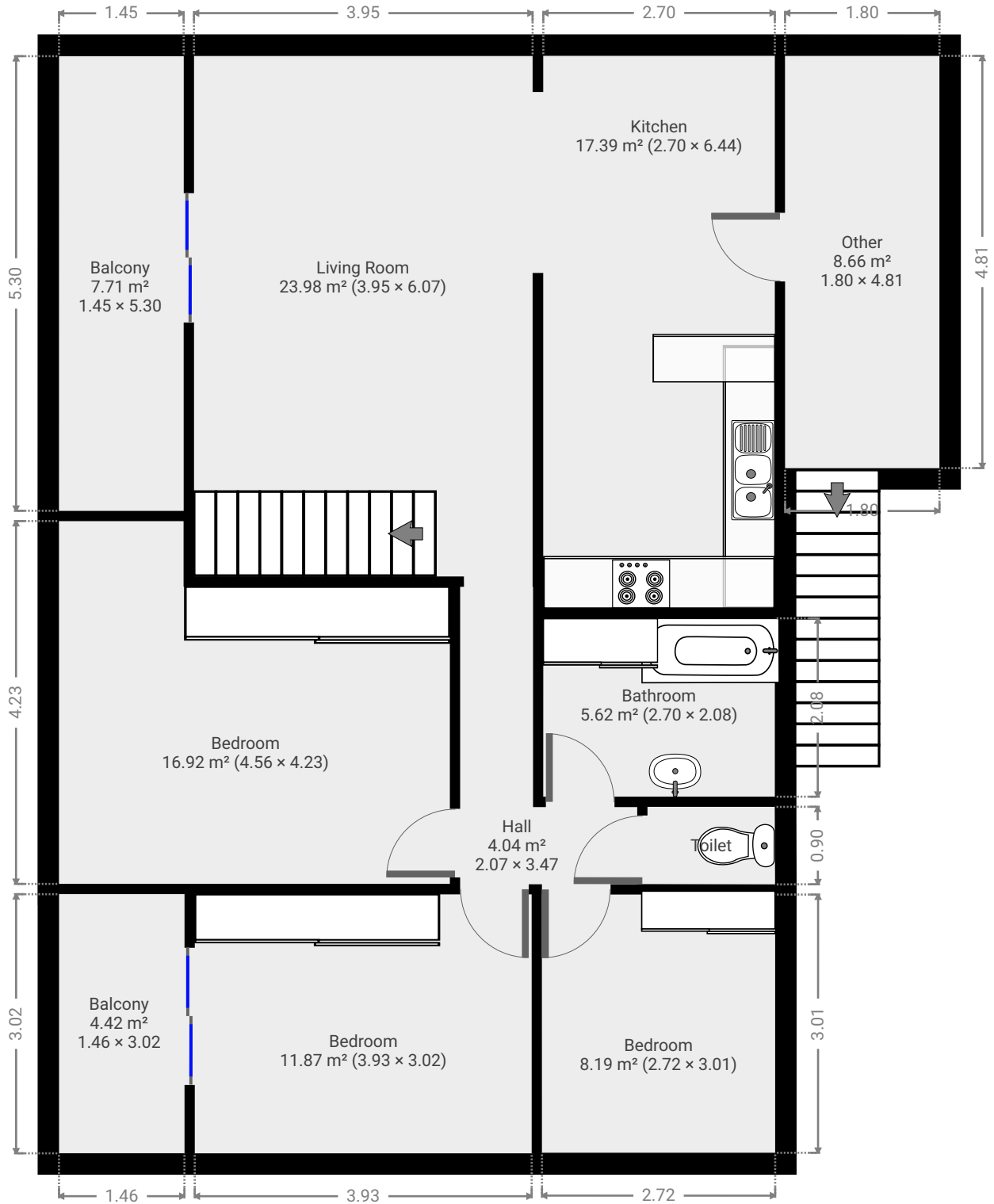

▼ **Balcony**
1st Floor

WIDTH: 3.02 m • LENGTH: 1.46 m
AREA: 4.42 m² • PERIMETER: 8.97 m

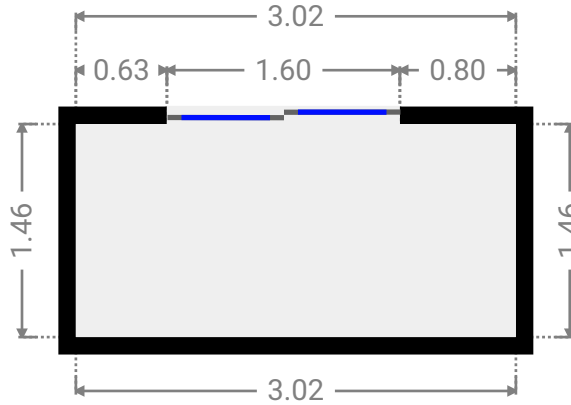
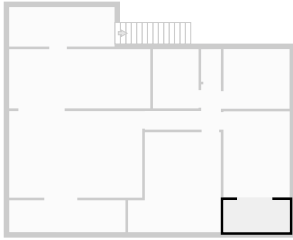

▼ **Balcony**
1st Floor

WIDTH: 5.30 m • LENGTH: 1.45 m
AREA: 7.71 m² • PERIMETER: 13.51 m

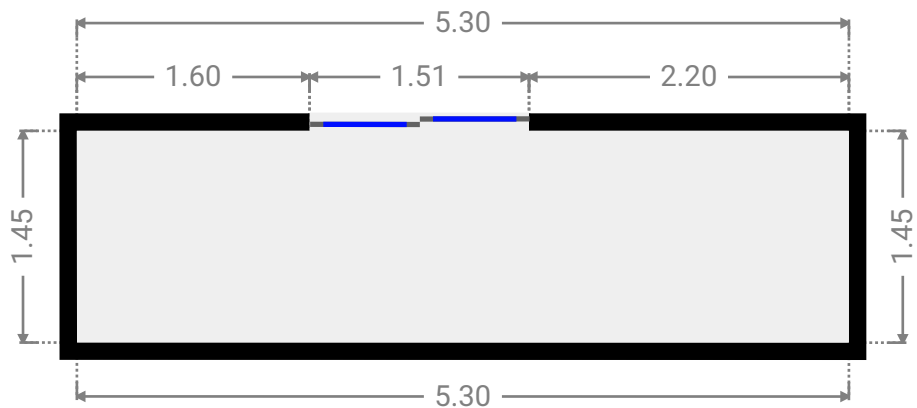
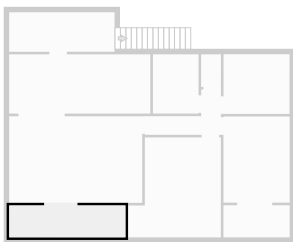

▼ Bathroom
1st Floor

WIDTH: 2.08 m • LENGTH: 2.70 m
AREA: 5.62 m² • PERIMETER: 9.56 m

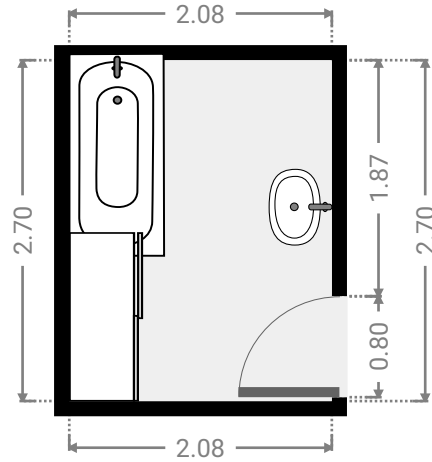
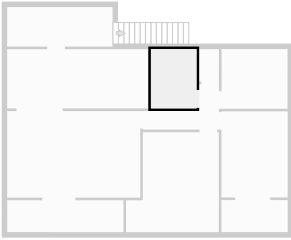

▼ Bedroom
1st Floor

WIDTH: 4.23 m • LENGTH: 4.56 m
AREA: 16.92 m² • PERIMETER: 17.58 m

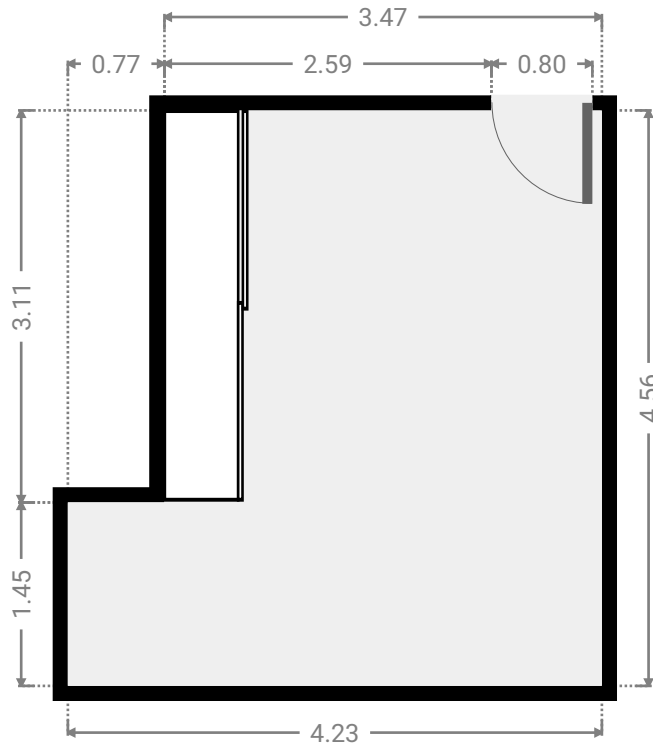
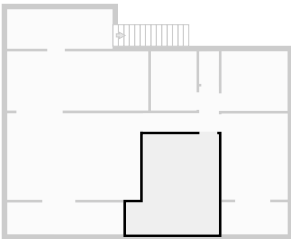

▼ **Bedroom**
1st Floor

WIDTH: 3.02 m • LENGTH: 3.93 m
AREA: 11.87 m² • PERIMETER: 13.90 m

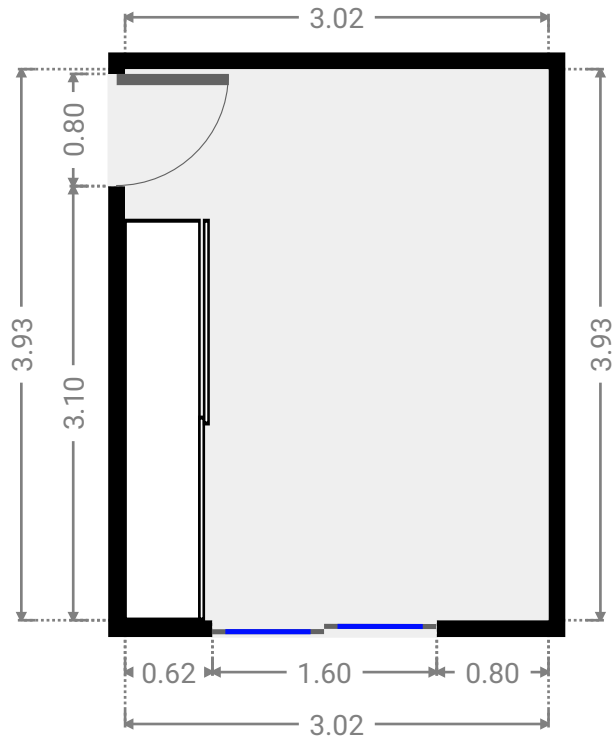
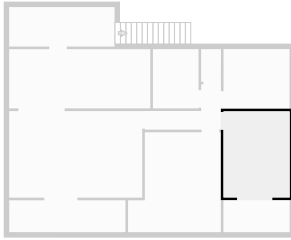

▼ **Bedroom**
1st Floor

WIDTH: 3.01 m • LENGTH: 2.72 m
AREA: 8.19 m² • PERIMETER: 11.46 m

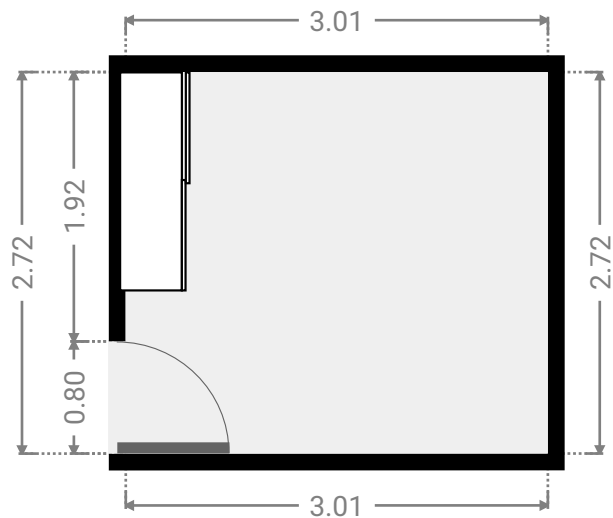
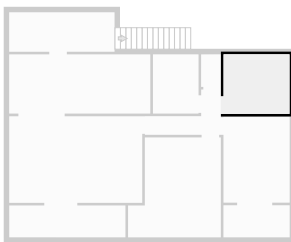

▼ **Hall**
1st Floor

WIDTH: 3.47 m • LENGTH: 2.07 m
AREA: 4.04 m² • PERIMETER: 11.07 m

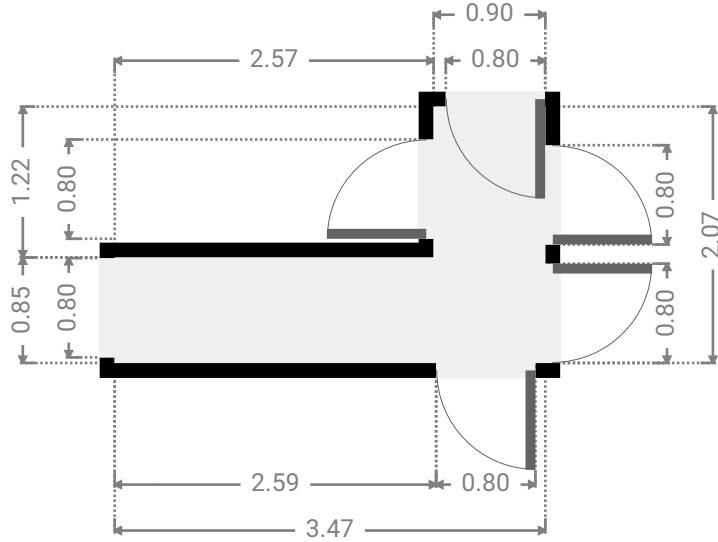
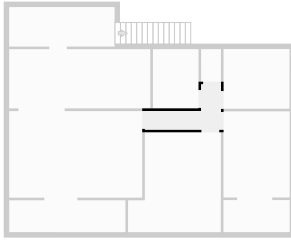

▼ **Kitchen**
1st Floor

WIDTH: 6.44 m • LENGTH: 2.70 m
AREA: 17.39 m² • PERIMETER: 18.28 m

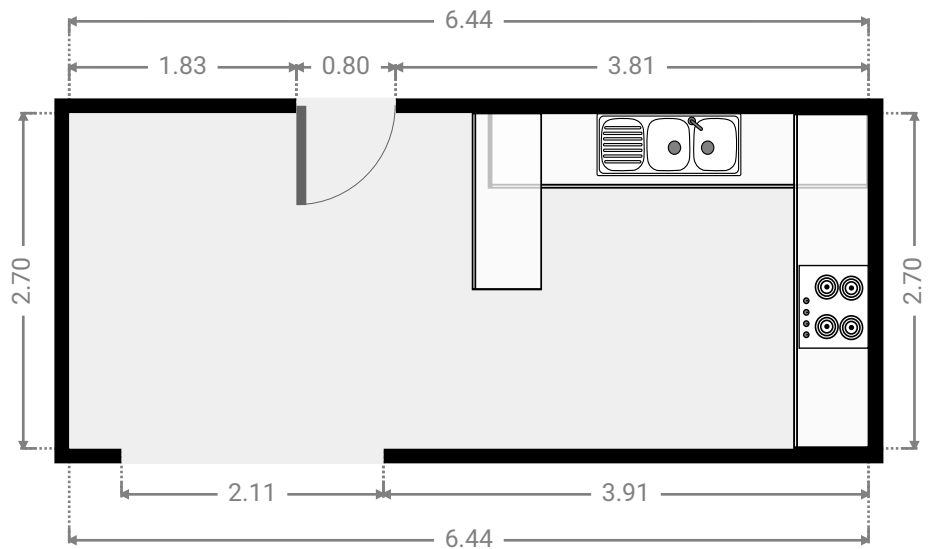
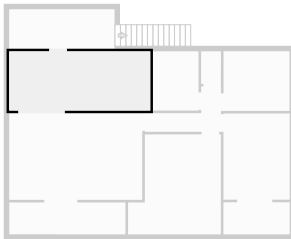

▼ **Living Room**
1st Floor

WIDTH: 6.07 m • LENGTH: 3.95 m
AREA: 23.98 m² • PERIMETER: 20.04 m

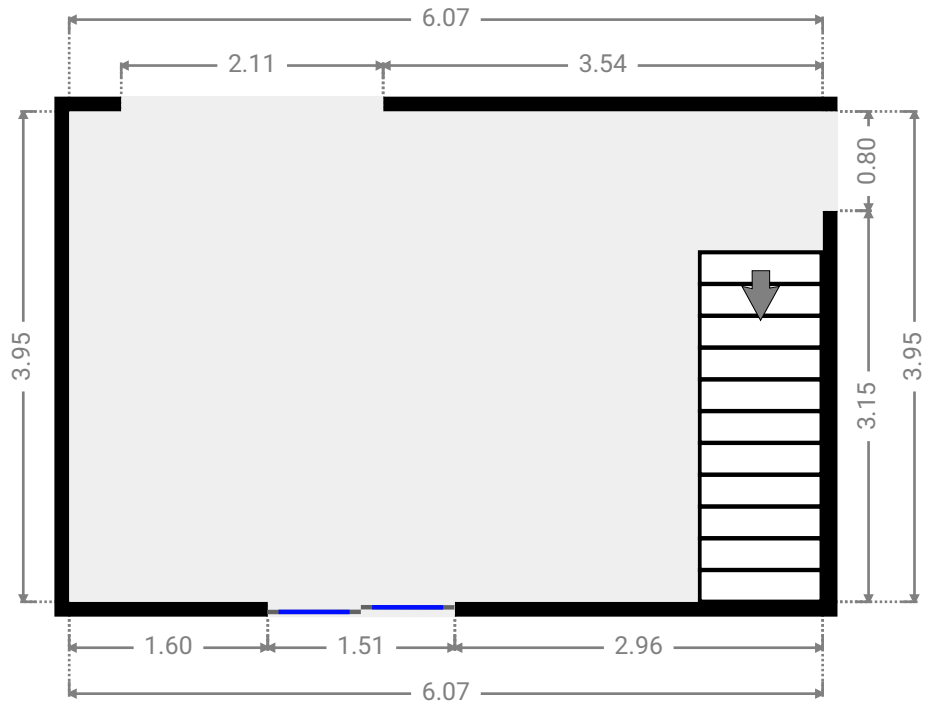
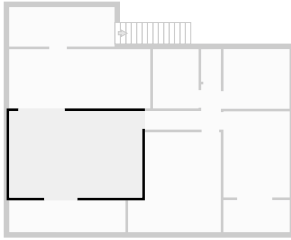

▼ **Other**
1st Floor

WIDTH: 4.81 m • LENGTH: 1.80 m
AREA: 8.66 m² • PERIMETER: 13.22 m

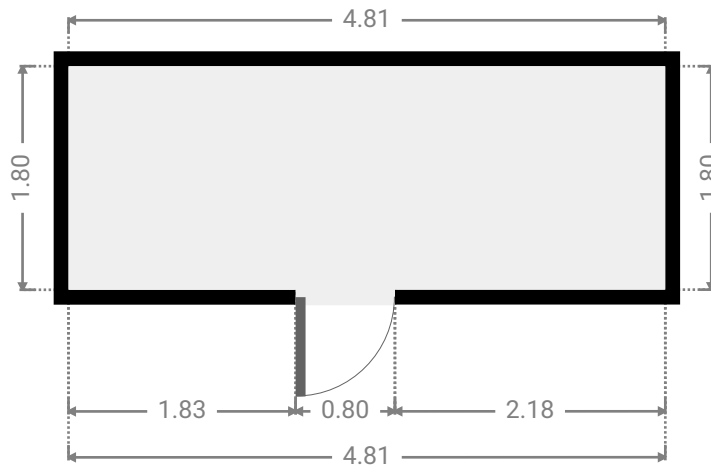
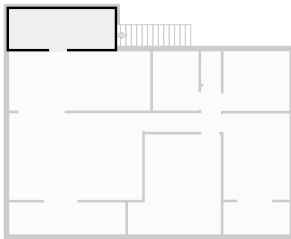

▼ Toilet
1st Floor

WIDTH: 0.90 m • LENGTH: 1.49 m
AREA: 1.34 m² • PERIMETER: 4.78 m

