

124 Fons Drive

Ground Floor

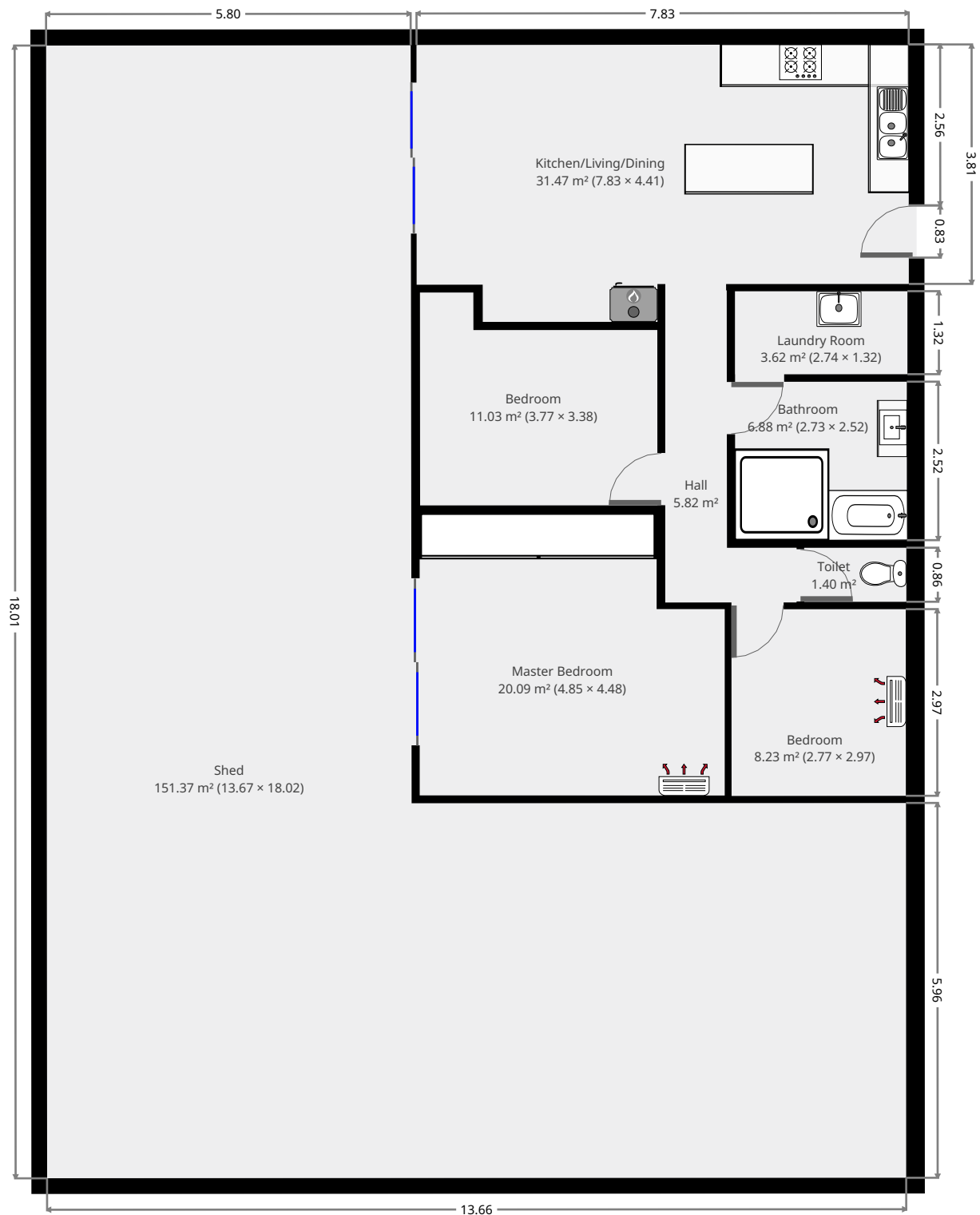

THIS FLOORPLAN IS PROVIDED WITHOUT WARRANTY OF ANY KIND. SENSOPIA DISCLAIMS ANY WARRANTY INCLUDING, WITHOUT LIMITATION, SATISFACTORY QUALITY OR ACCURACY OF DIMENSIONS.



124 Fons Drive

Kitchen/Living/Dining

Width: 4.41 m
 Length: 7.83 m
 Area: 31.47 m²
 Perimeter: 24.47 m

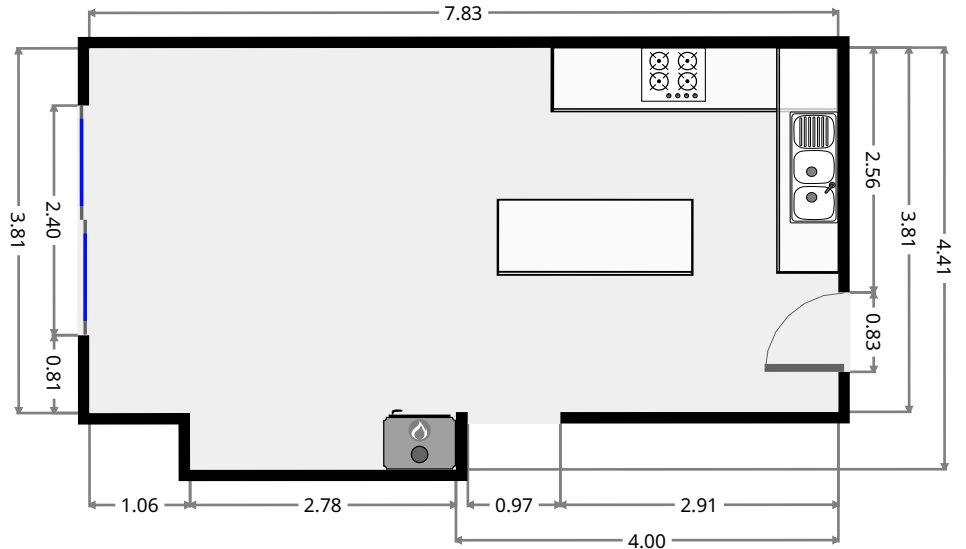
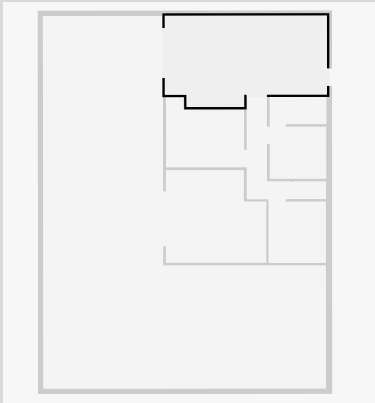

Hall

Width: 2.09 m
 Length: 4.96 m
 Area: 5.82 m²
 Perimeter: 14.10 m

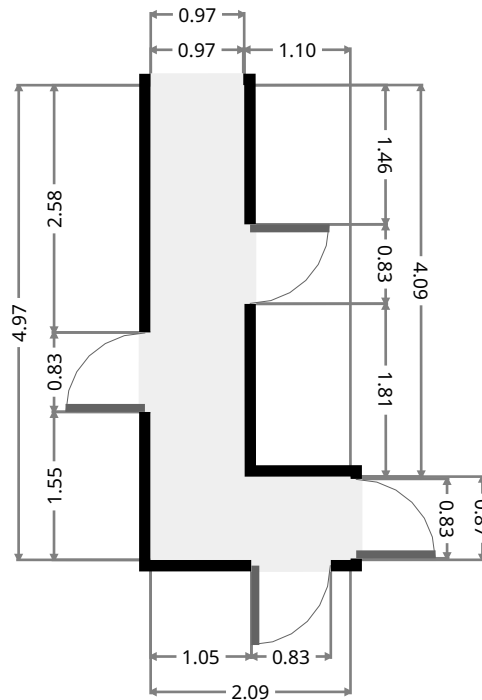
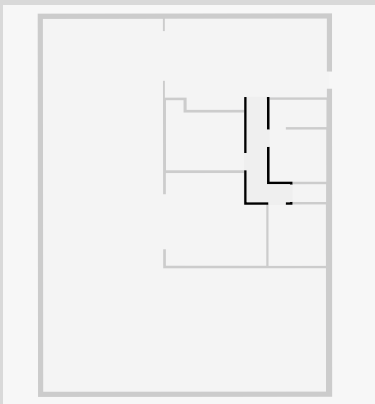

THIS FLOORPLAN IS PROVIDED WITHOUT WARRANTY OF ANY KIND. SENSOPIA DISCLAIMS ANY WARRANTY INCLUDING, WITHOUT LIMITATION, SATISFACTORY QUALITY OR ACCURACY OF DIMENSIONS.

124 Fons Drive

Bedroom

Width: 3.38 m
Length: 3.77 m
Area: 11.03 m²
Perimeter: 14.32 m

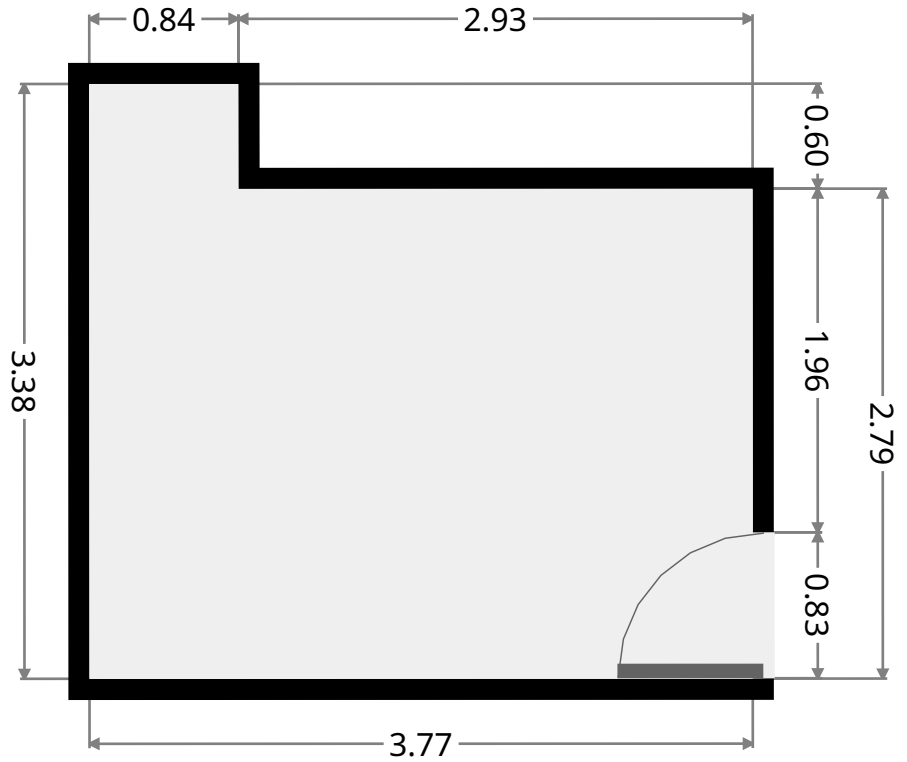
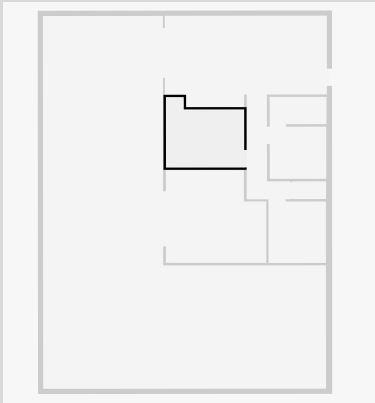

Laundry Room

Width: 1.32 m
Length: 2.74 m
Area: 3.62 m²
Perimeter: 8.13 m

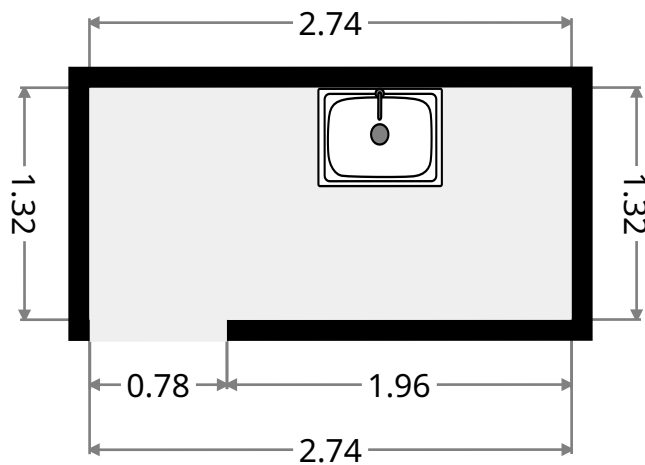
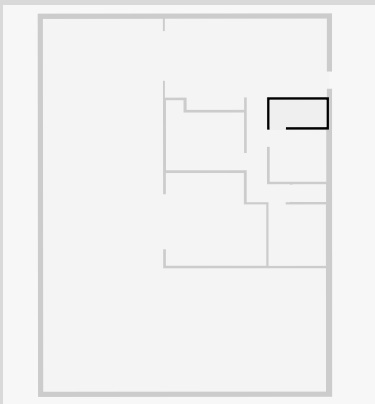

124 Fons Drive

Bathroom

Width: 2.52 m
 Length: 2.73 m
 Area: 6.88 m²
 Perimeter: 10.50 m

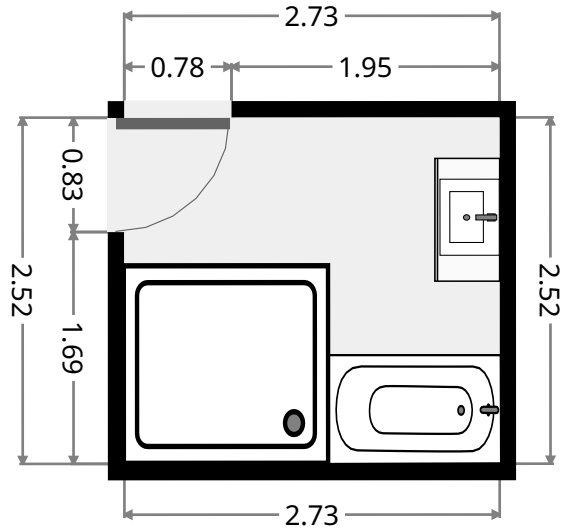
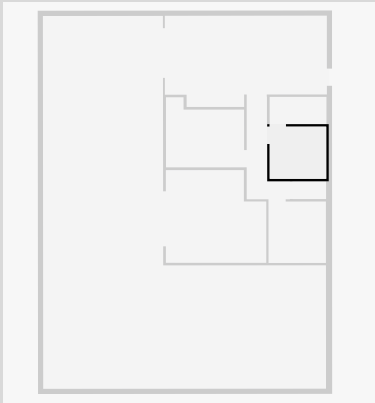

Master Bedroom

Width: 4.48 m
 Length: 4.85 m
 Area: 20.09 m²
 Perimeter: 18.66 m

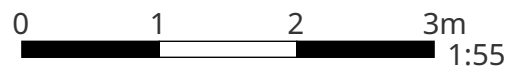
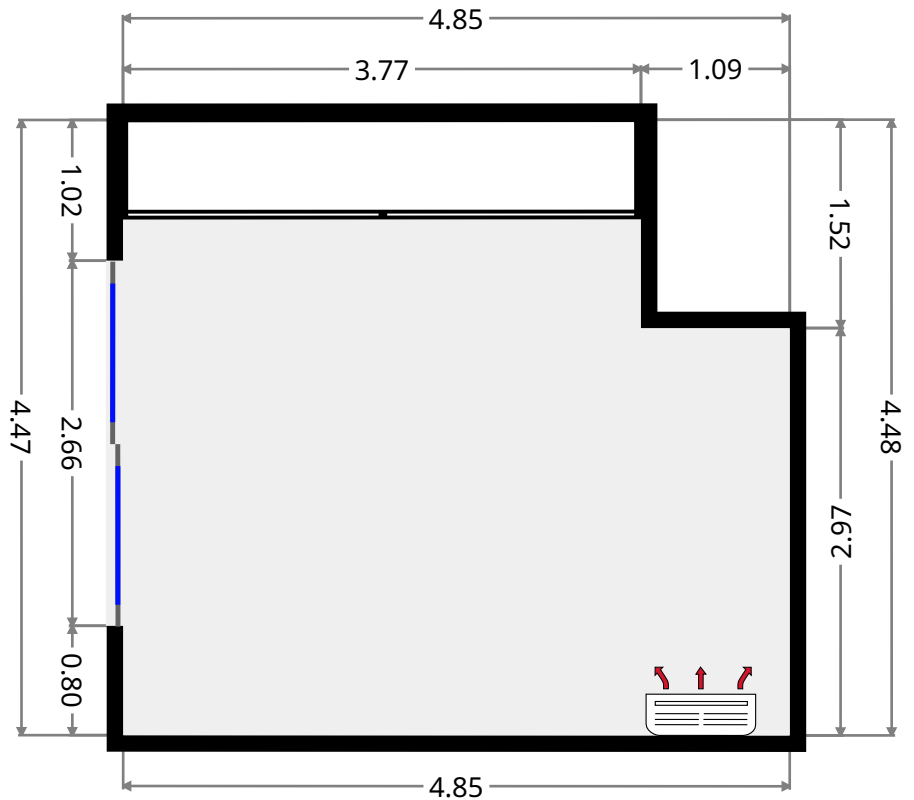
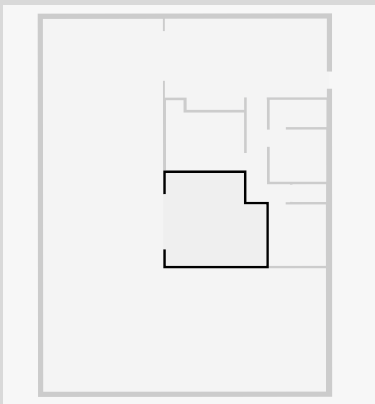

THIS FLOORPLAN IS PROVIDED WITHOUT WARRANTY OF ANY KIND. SENSOPIA DISCLAIMS ANY WARRANTY INCLUDING, WITHOUT LIMITATION, SATISFACTORY QUALITY OR ACCURACY OF DIMENSIONS.

124 Fons Drive

Bedroom

Width: 2.77 m
Length: 2.97 m
Area: 8.23 m²
Perimeter: 11.48 m

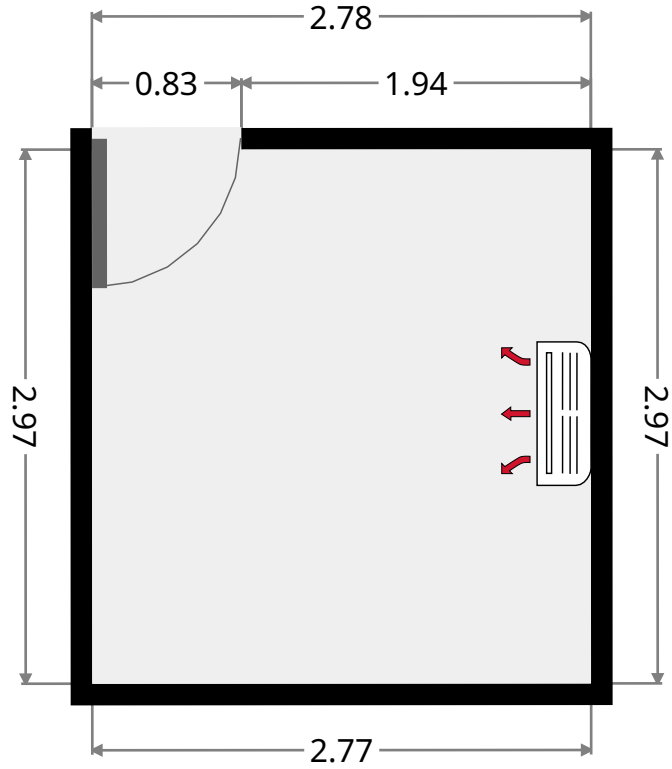
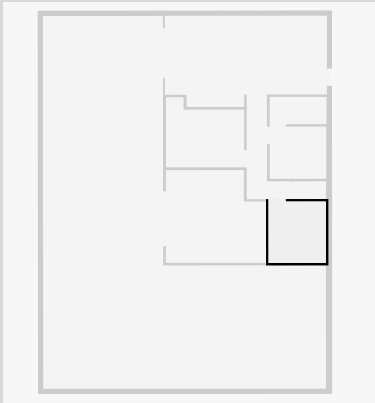

Toilet / Half Bath

Width: 0.86 m
Length: 1.62 m
Area: 1.40 m²
Perimeter: 4.97 m

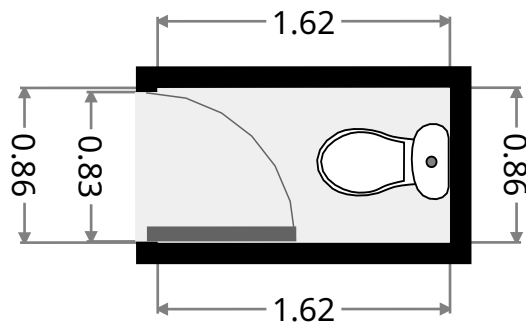
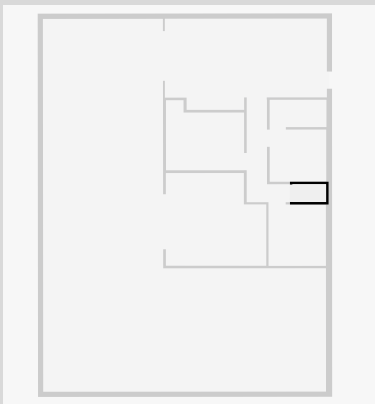

124 Fons Drive

Shed

Width: 13.67 m
Length: 18.02 m
Area: 151.37 m²
Perimeter: 63.35 m

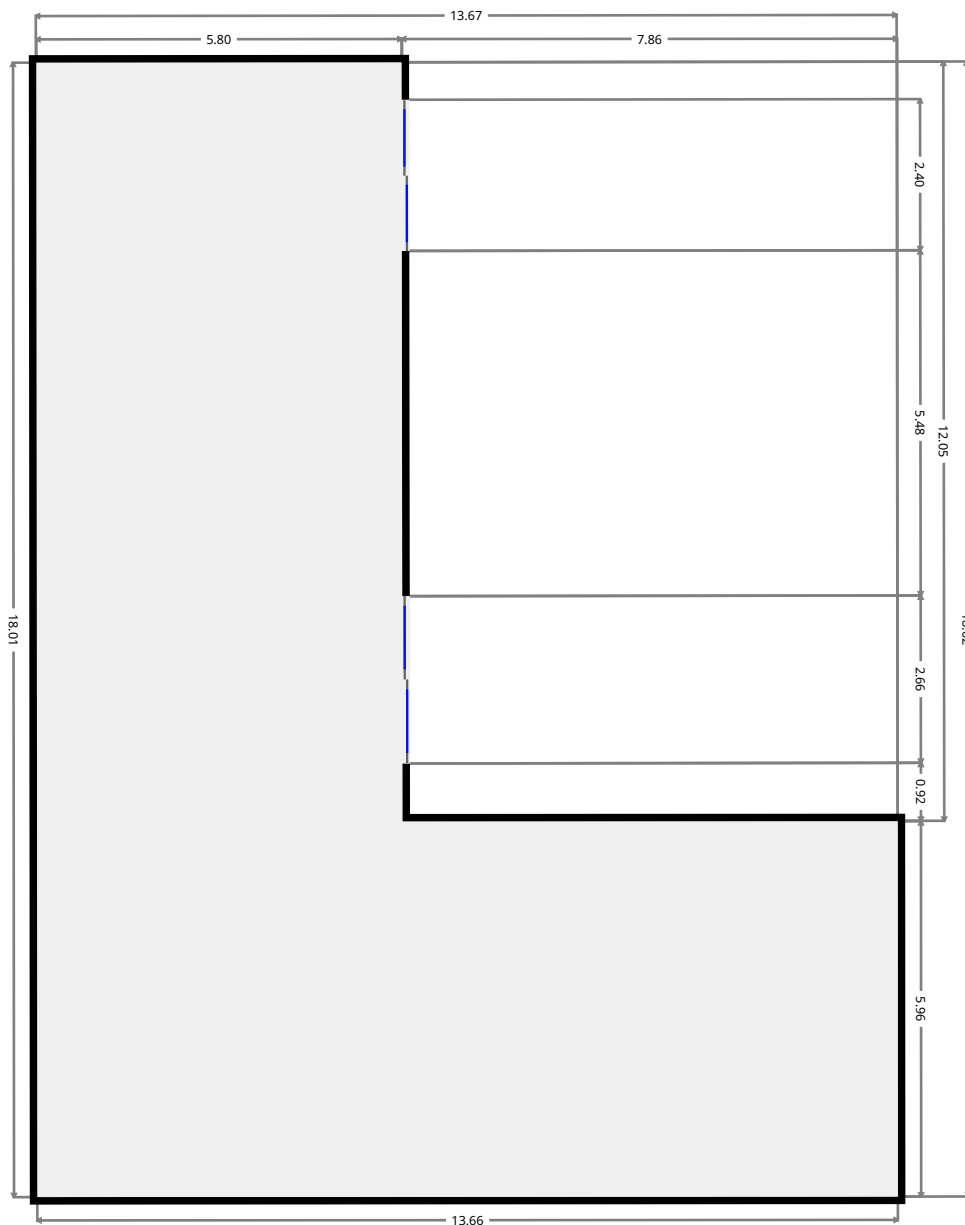
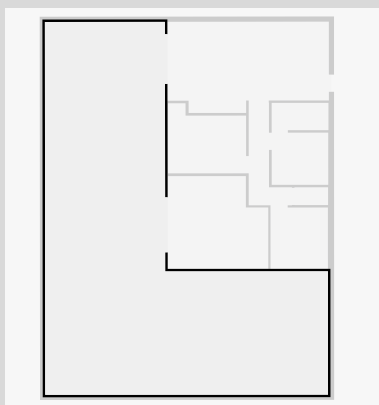

THIS FLOORPLAN IS PROVIDED WITHOUT WARRANTY OF ANY KIND. SENSOPIA DISCLAIMS ANY WARRANTY INCLUDING, WITHOUT LIMITATION, SATISFACTORY QUALITY OR ACCURACY OF DIMENSIONS.

