

# 124 Dee Street

Created on  
2021-04-08

Floors  
2

▼ Ground Floor

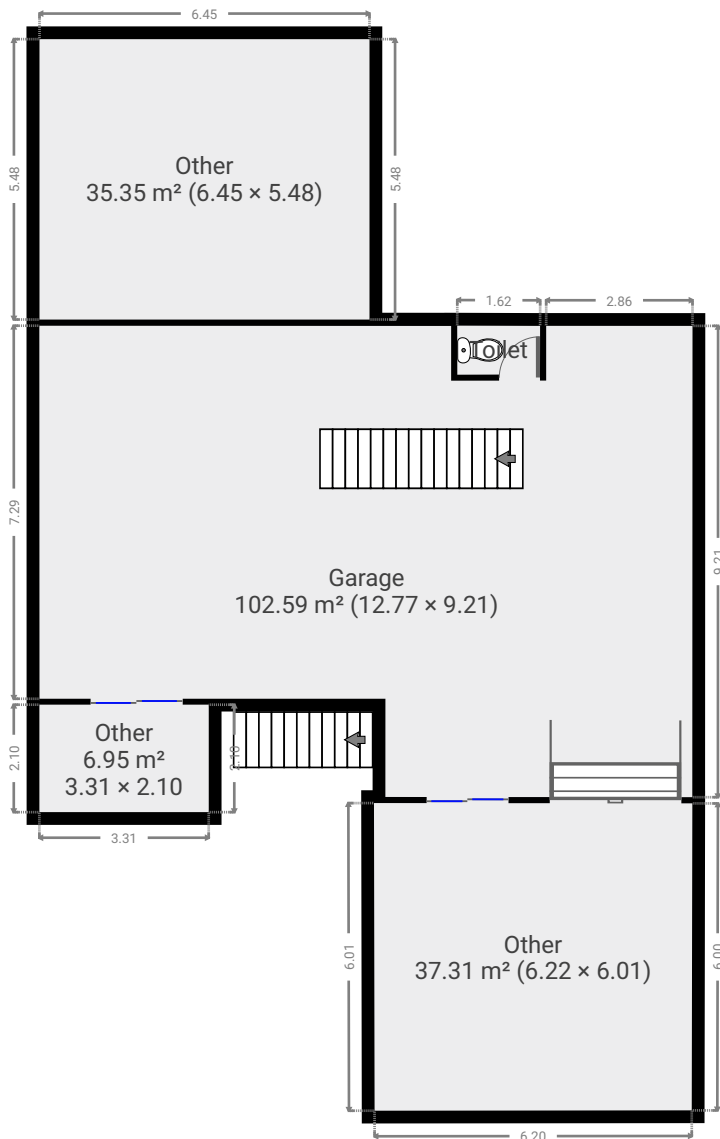
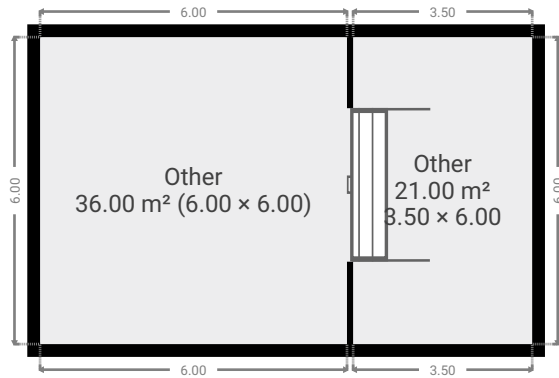

▼ Garage  
Ground Floor

WIDTH: 12.77 m • LENGTH: 9.21 m  
AREA: 102.59 m<sup>2</sup> • PERIMETER: 46.09 m

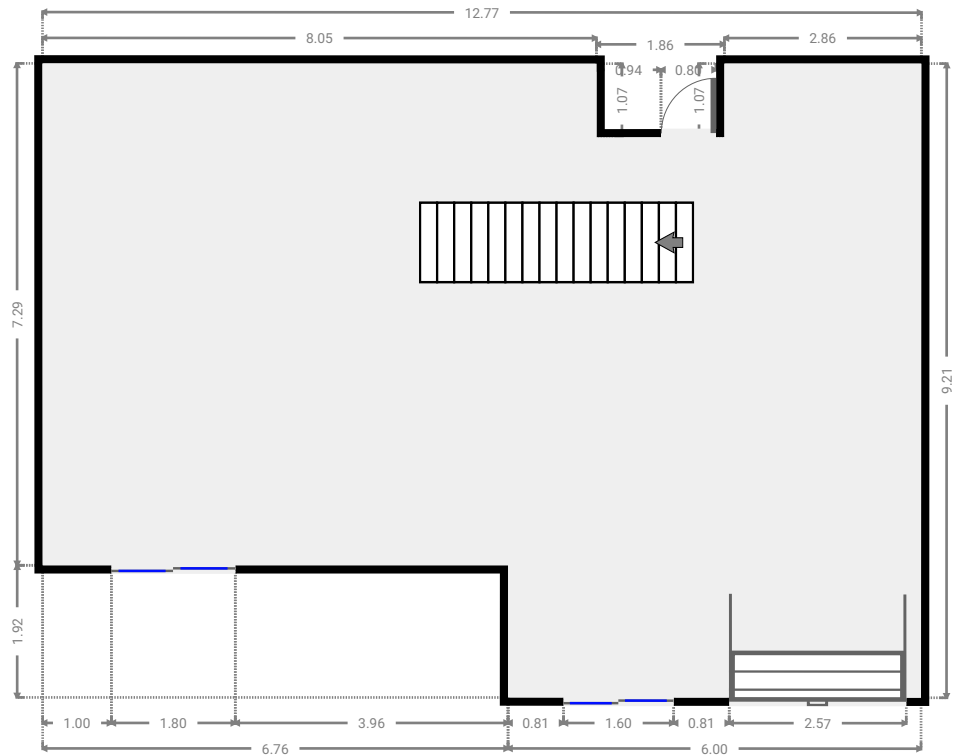
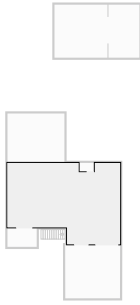

▼ Toilet  
Ground Floor

WIDTH: 1.62 m • LENGTH: 0.96 m  
AREA: 1.54 m<sup>2</sup> • PERIMETER: 5.14 m

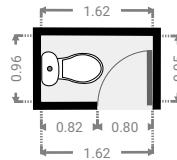
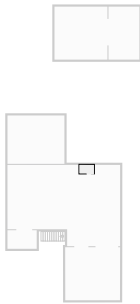

▼ Other  
Ground Floor

WIDTH: 6.45 m • LENGTH: 5.48 m  
AREA: 35.35 m<sup>2</sup> • PERIMETER: 23.86 m

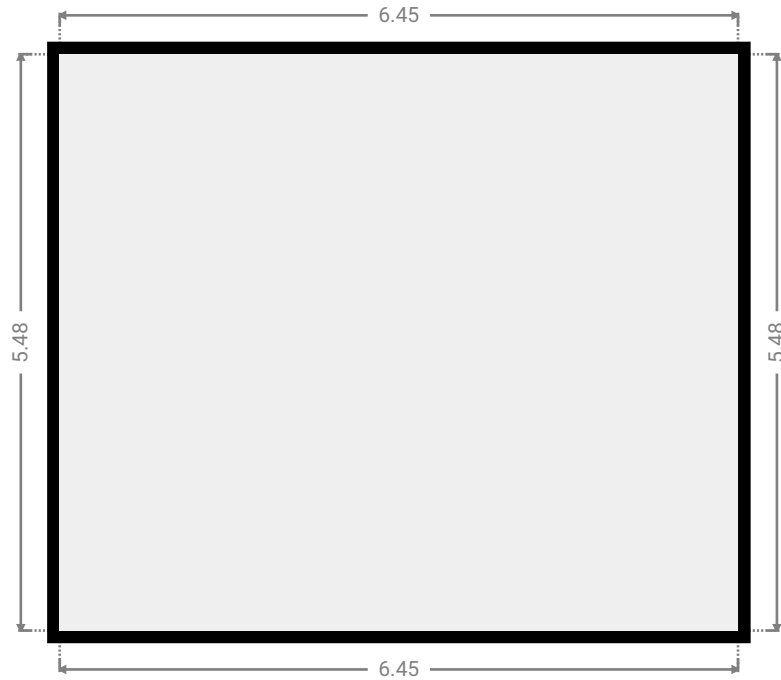
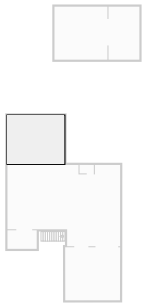

▼ Other  
Ground Floor

WIDTH: 3.50 m • LENGTH: 6.00 m  
AREA: 21.00 m<sup>2</sup> • PERIMETER: 19.00 m

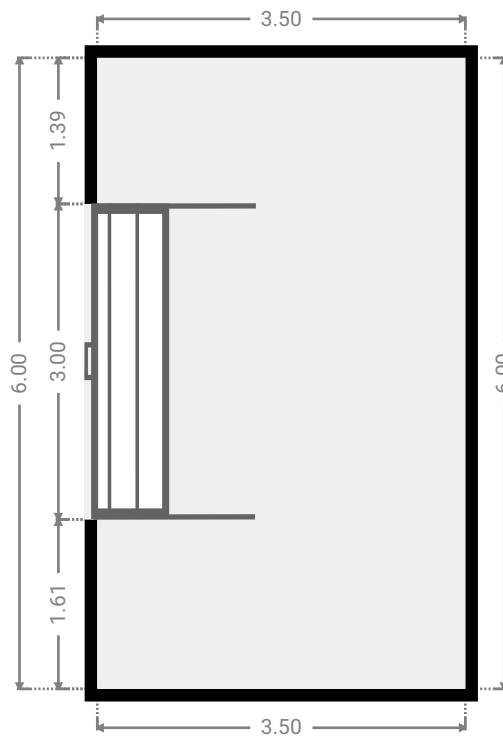
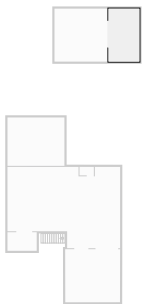

▼ Other  
Ground Floor

WIDTH: 6.00 m • LENGTH: 6.00 m  
AREA: 36.00 m<sup>2</sup> • PERIMETER: 24.00 m

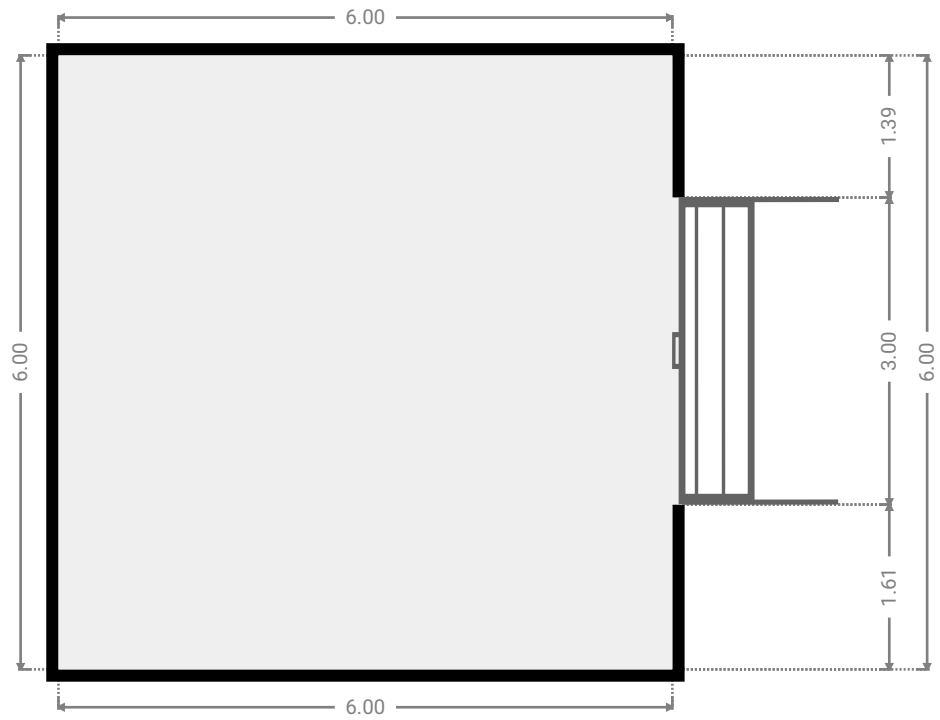
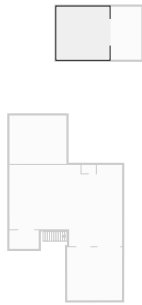

▼ Other  
Ground Floor

WIDTH: 3.31 m • LENGTH: 2.10 m  
AREA: 6.95 m<sup>2</sup> • PERIMETER: 10.82 m

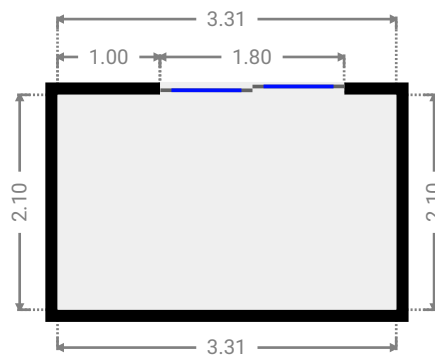
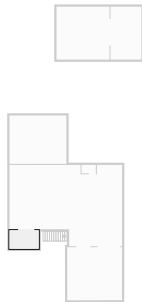

▼ Other  
Ground Floor

WIDTH: 6.22 m • LENGTH: 6.01 m  
AREA: 37.31 m<sup>2</sup> • PERIMETER: 24.44 m

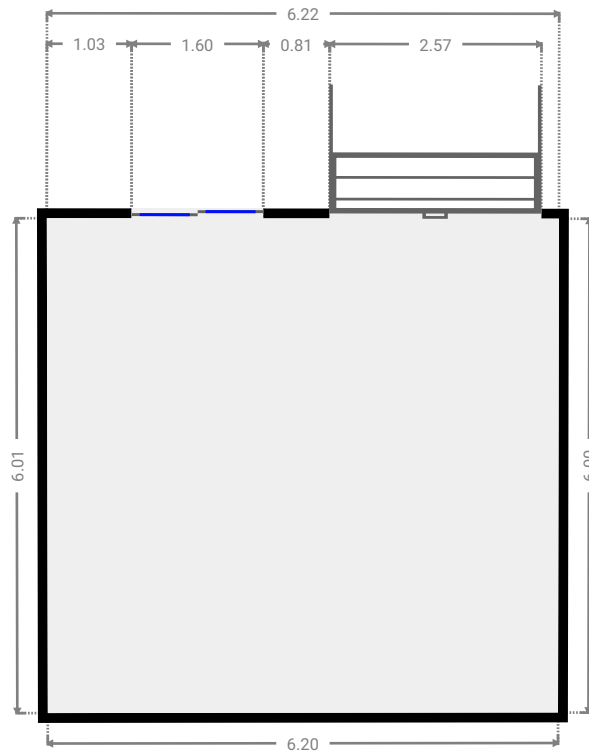
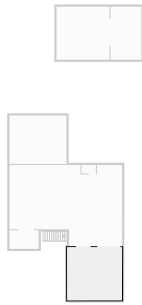

▼ 1st Floor

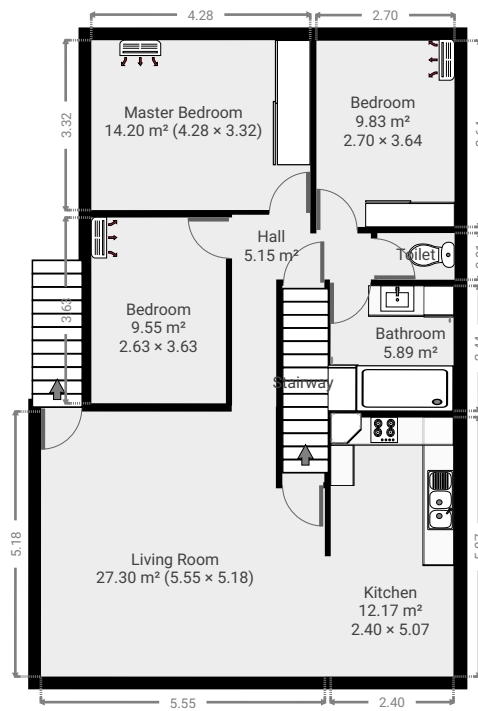

▼ **Living Room**  
1st Floor

WIDTH: 5.18 m • LENGTH: 5.55 m  
AREA: 27.30 m<sup>2</sup> • PERIMETER: 21.46 m

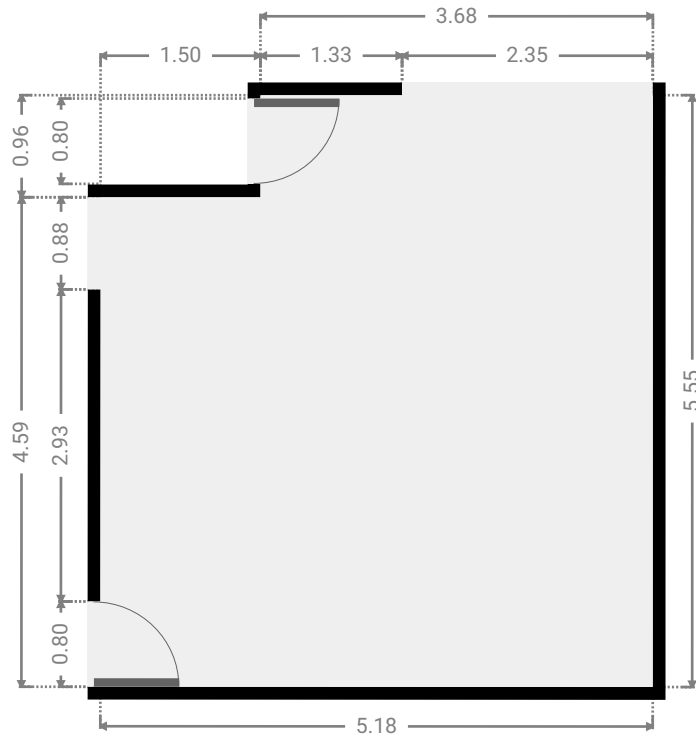
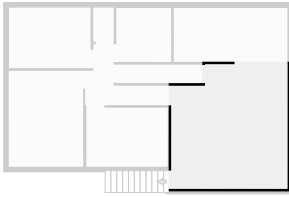

▼ **Kitchen**  
1st Floor

WIDTH: 5.07 m • LENGTH: 2.40 m  
AREA: 12.17 m<sup>2</sup> • PERIMETER: 14.94 m

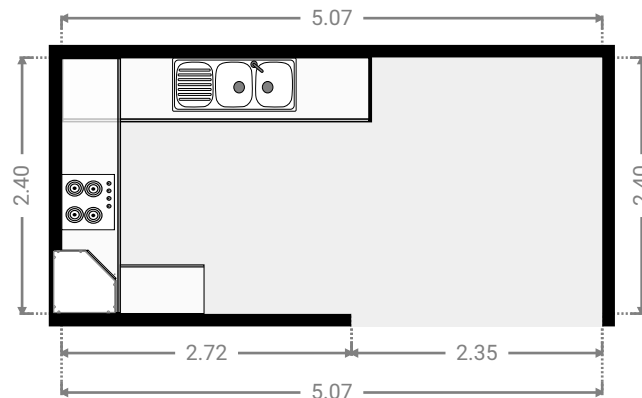
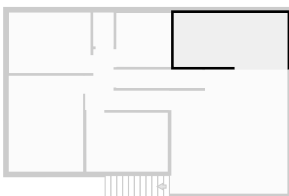



▼ Hall  
1st Floor

WIDTH: 3.75 m • LENGTH: 2.71 m  
AREA: 5.15 m<sup>2</sup> • PERIMETER: 12.93 m

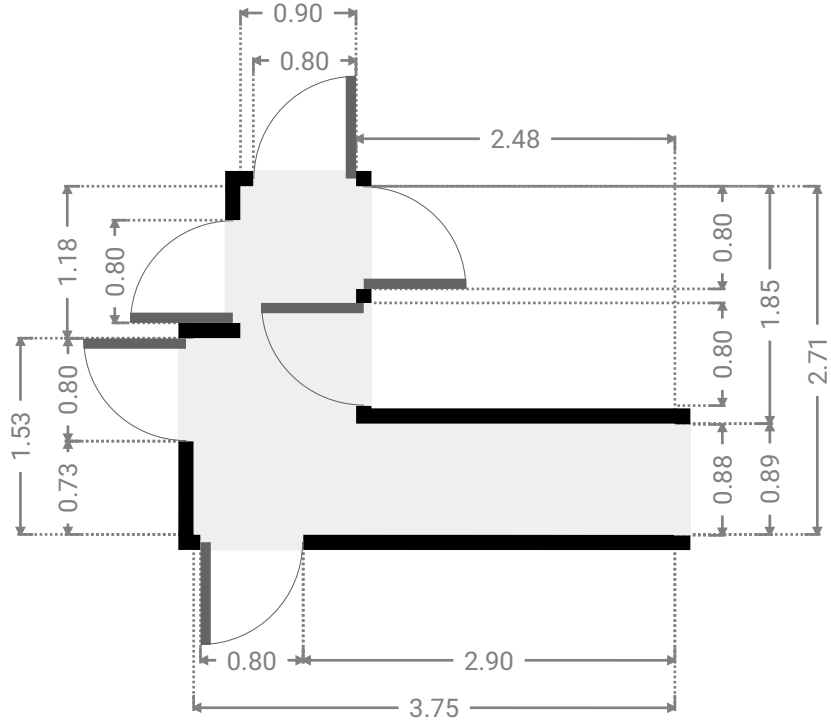
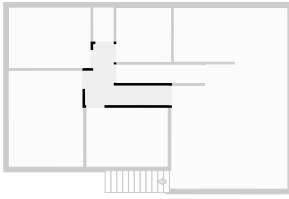

▼ Stairway  
1st Floor

WIDTH: 3.84 m • LENGTH: 0.82 m  
AREA: 3.15 m<sup>2</sup> • PERIMETER: 9.32 m

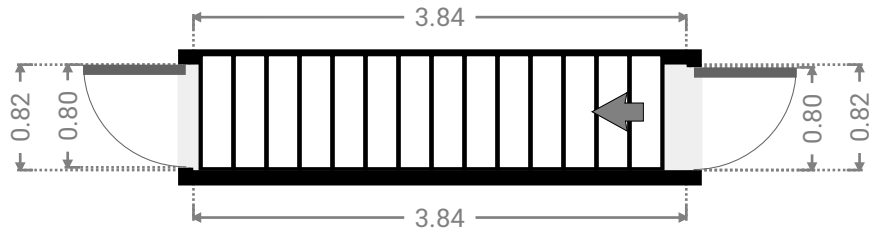
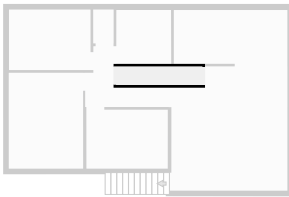

▼ **Bedroom**  
1st Floor

WIDTH: 3.63 m • LENGTH: 2.63 m  
AREA: 9.55 m<sup>2</sup> • PERIMETER: 12.53 m

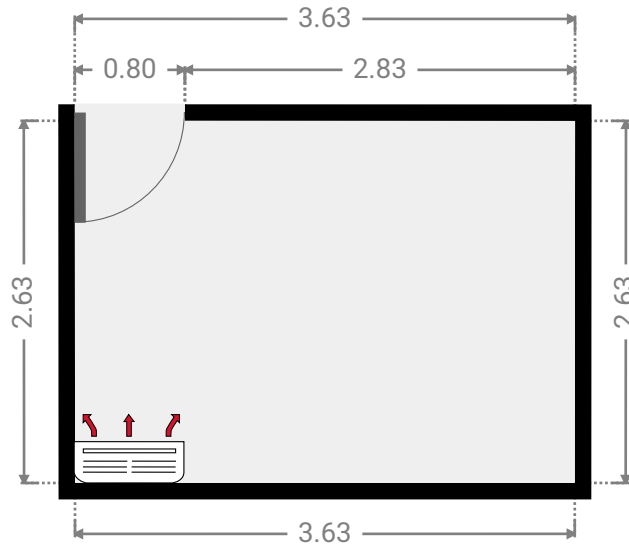
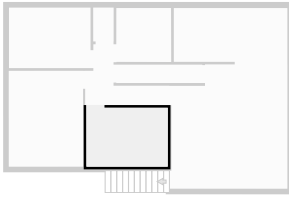

▼ **Master Bedroom**  
1st Floor

WIDTH: 3.32 m • LENGTH: 4.28 m  
AREA: 14.20 m<sup>2</sup> • PERIMETER: 15.20 m

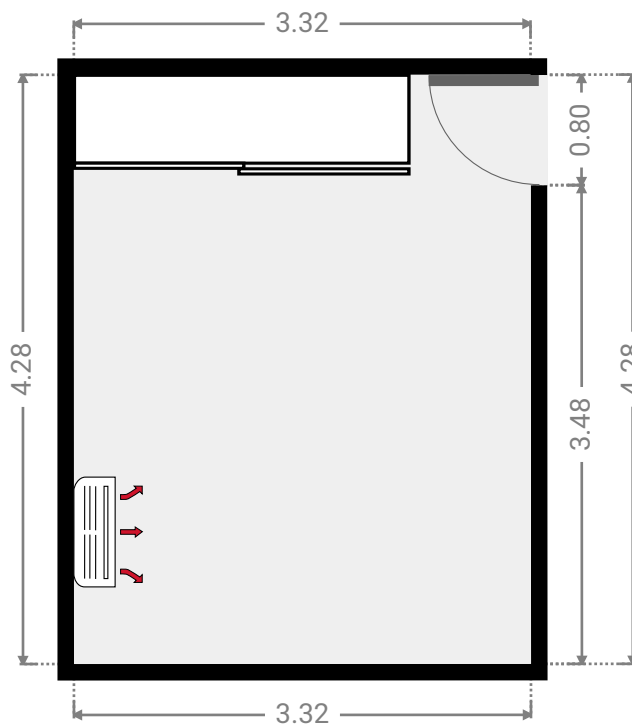
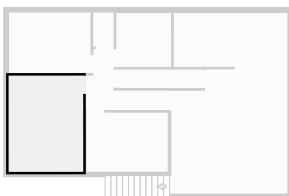

▼ **Bedroom**  
1st Floor

WIDTH: 3.64 m • LENGTH: 2.70 m  
AREA: 9.83 m<sup>2</sup> • PERIMETER: 12.68 m

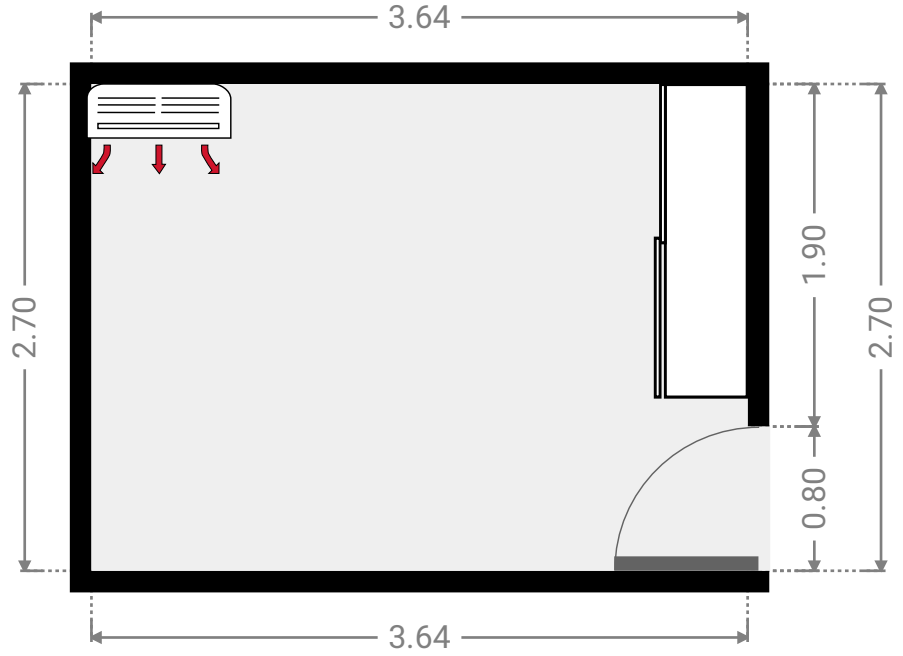
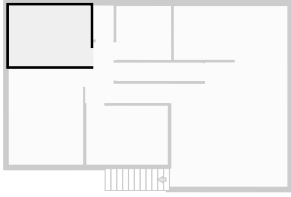

▼ **Toilet**  
1st Floor

WIDTH: 0.91 m • LENGTH: 1.51 m  
AREA: 1.38 m<sup>2</sup> • PERIMETER: 4.84 m

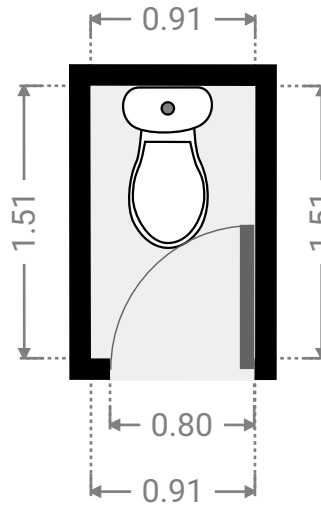
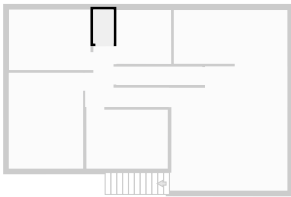

▼ **Bathroom**  
1st Floor

WIDTH: 2.45 m • LENGTH: 2.42 m  
AREA: 5.89 m<sup>2</sup> • PERIMETER: 9.71 m

