

# 123 Springfield Drive

## Ground Floor



THIS FLOORPLAN IS PROVIDED WITHOUT WARRANTY OF ANY KIND. SENSOPIA DISCLAIMS ANY WARRANTY INCLUDING, WITHOUT LIMITATION, SATISFACTORY QUALITY OR ACCURACY OF DIMENSIONS.



# 123 Springfield Drive

## Hallway

Width: 2.88 m  
 Length: 8.65 m  
 Area: 13.44 m<sup>2</sup>  
 Perimeter: 24.19 m

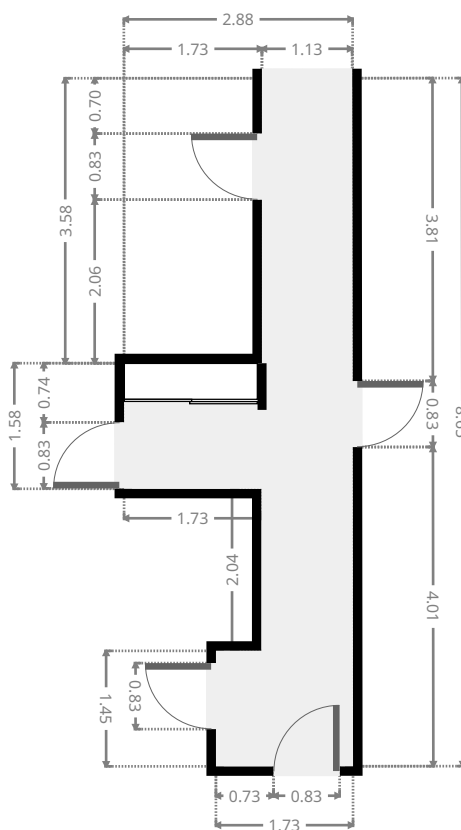
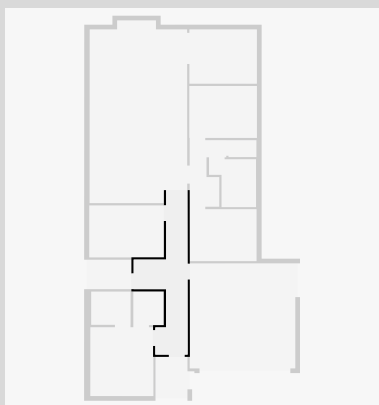

## Master Bedroom

Width: 3.36 m  
 Length: 3.67 m  
 Area: 12.34 m<sup>2</sup>  
 Perimeter: 14.06 m

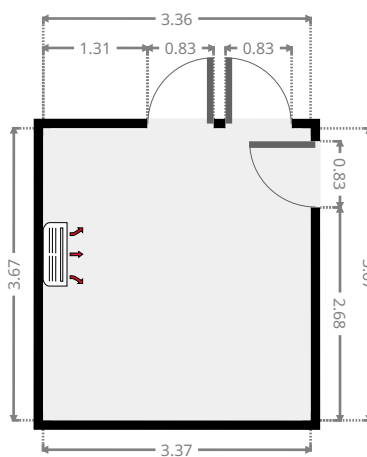
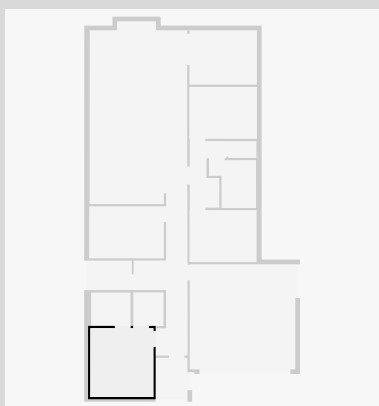

# 123 Springfield Drive

## Bathroom

Width: 1.77 m  
Length: 2.10 m  
Area: 3.72 m<sup>2</sup>  
Perimeter: 7.74 m

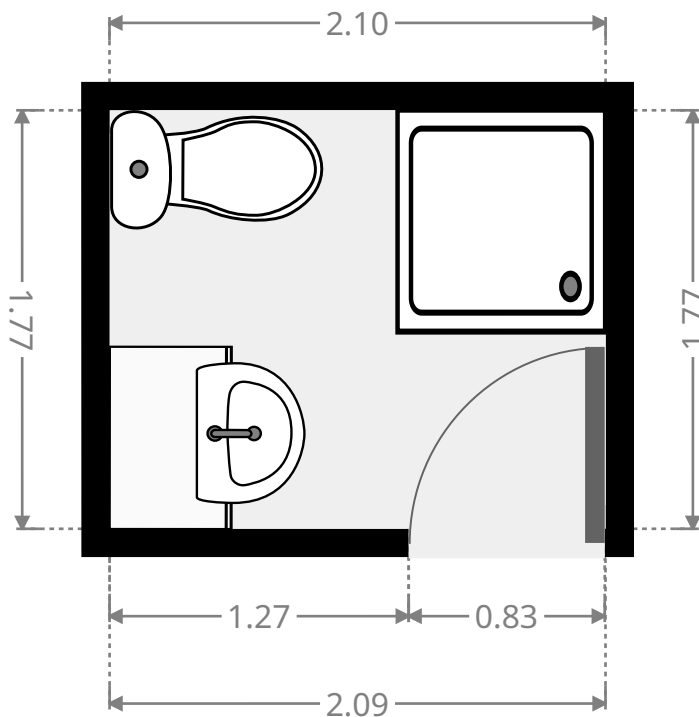

## WIR

Width: 1.61 m  
Length: 1.80 m  
Area: 2.90 m<sup>2</sup>  
Perimeter: 6.82 m

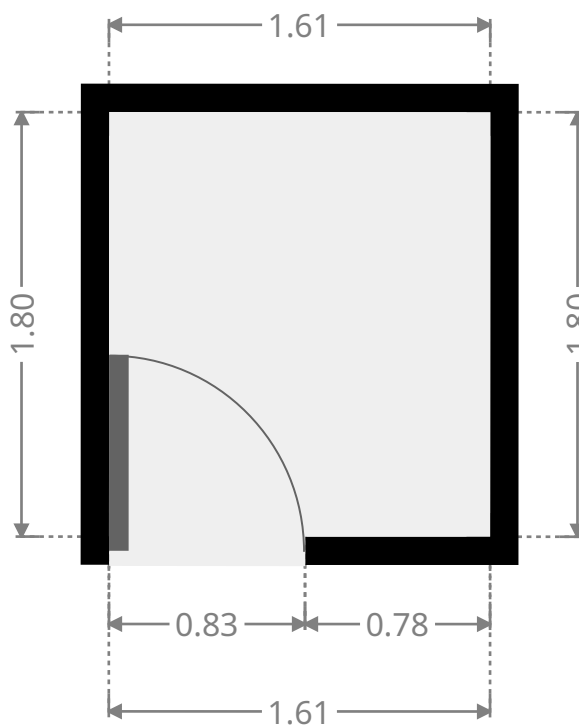
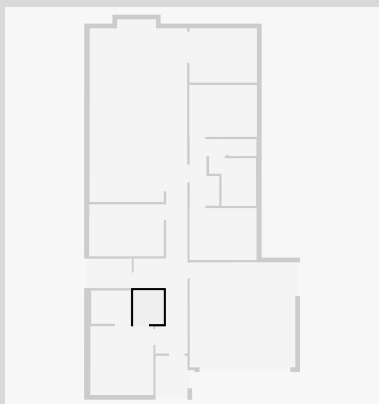

# 123 Springfield Drive

## Laundry Room

Width: 1.57 m  
Length: 2.29 m  
Area: 3.60 m<sup>2</sup>  
Perimeter: 7.72 m

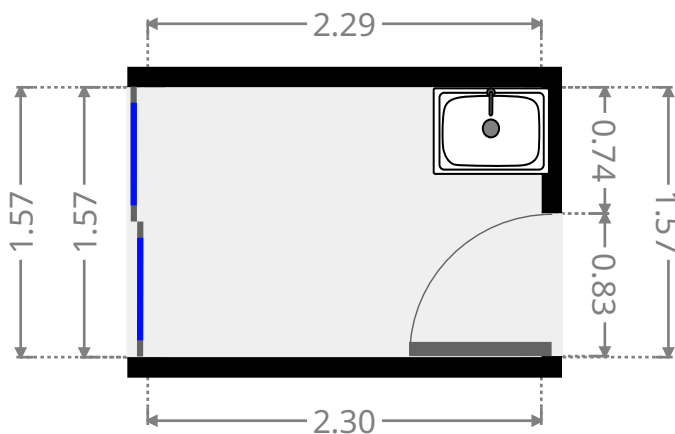

## Bedroom

Width: 2.77 m  
Length: 3.97 m  
Area: 11.00 m<sup>2</sup>  
Perimeter: 13.48 m

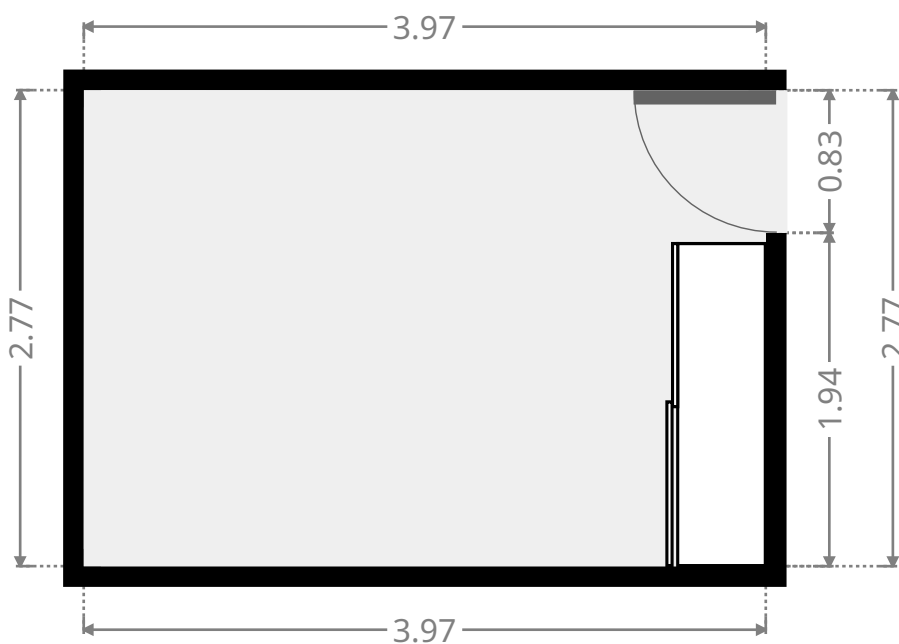
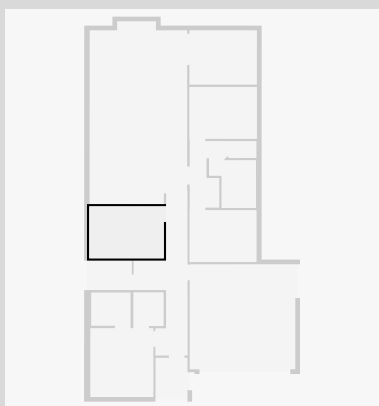

THIS FLOORPLAN IS PROVIDED WITHOUT WARRANTY OF ANY KIND. SENSOPIA DISCLAIMS ANY WARRANTY INCLUDING, WITHOUT LIMITATION, SATISFACTORY QUALITY OR ACCURACY OF DIMENSIONS.

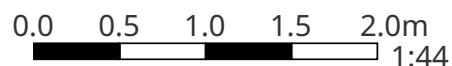

# 123 Springfield Drive

## Garage

Width: 5.60 m  
 Length: 5.63 m  
 Area: 31.53 m<sup>2</sup>  
 Perimeter: 22.46 m

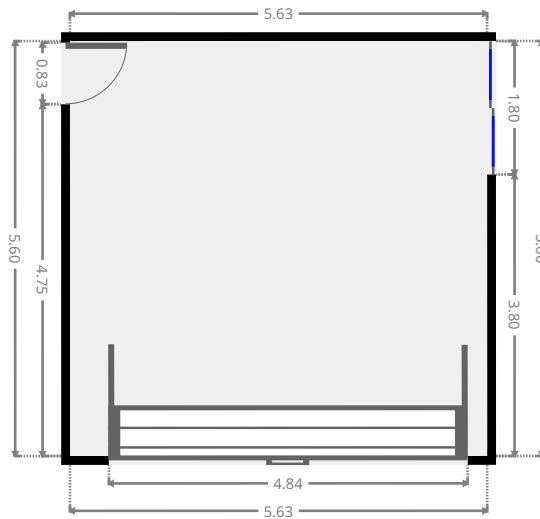
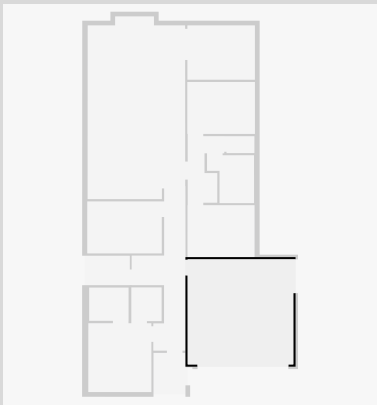

## Kitchen/Living/Dining

Width: 5.21 m  
 Length: 9.74 m  
 Area: 48.30 m<sup>2</sup>  
 Perimeter: 29.88 m

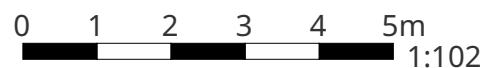
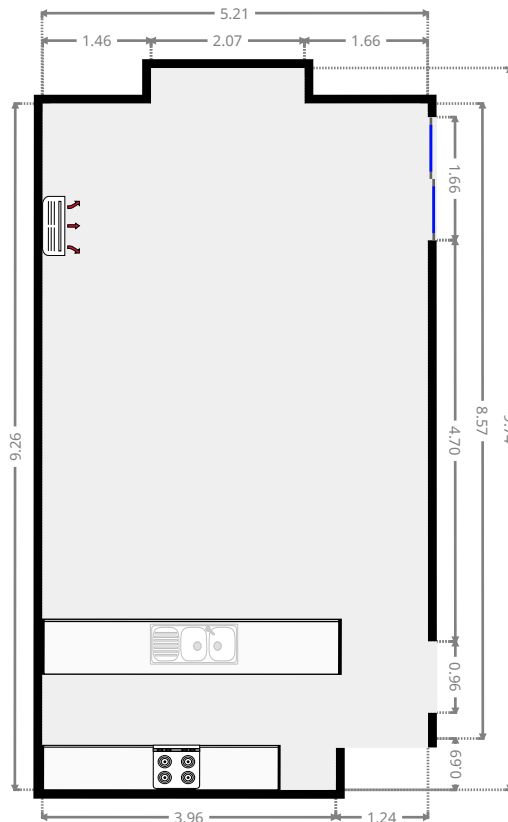
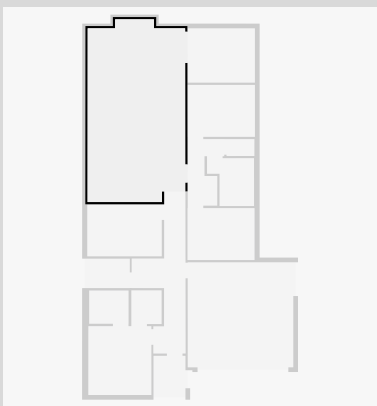

THIS FLOORPLAN IS PROVIDED WITHOUT WARRANTY OF ANY KIND. SENSOPIA DISCLAIMS ANY WARRANTY INCLUDING, WITHOUT LIMITATION, SATISFACTORY QUALITY OR ACCURACY OF DIMENSIONS.

# 123 Springfield Drive

## Hall

Width: 1.95 m  
 Length: 3.55 m  
 Area: 5.22 m<sup>2</sup>  
 Perimeter: 12.36 m

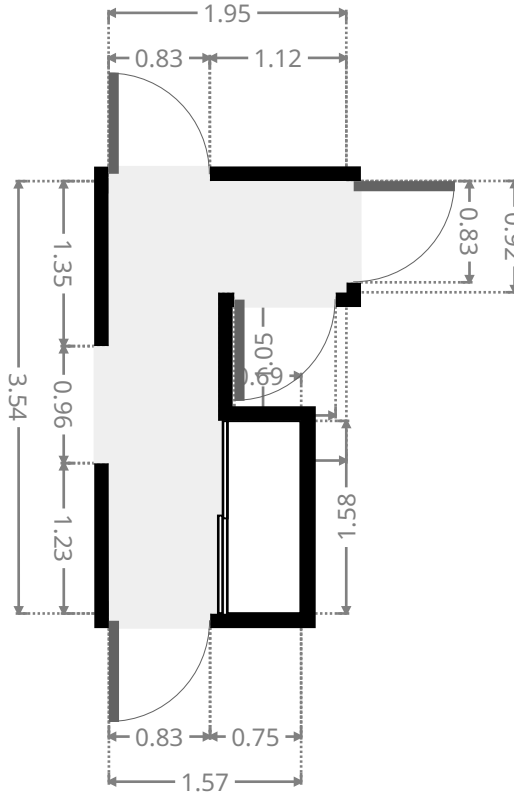

## Bedroom

Width: 2.77 m  
 Length: 3.58 m  
 Area: 9.90 m<sup>2</sup>  
 Perimeter: 12.69 m

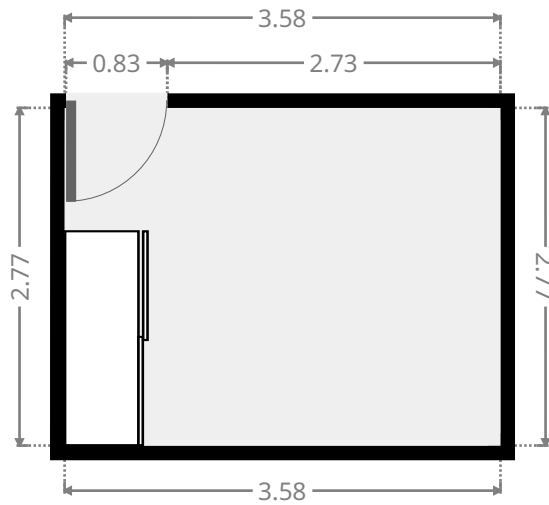
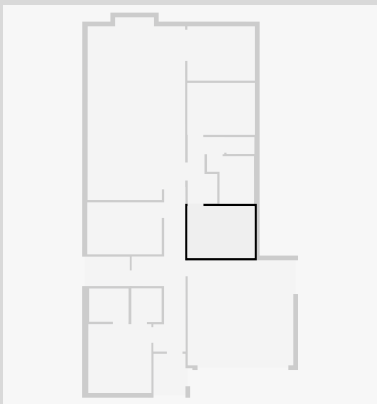

THIS FLOORPLAN IS PROVIDED WITHOUT WARRANTY OF ANY KIND. SENSOPIA DISCLAIMS ANY WARRANTY INCLUDING, WITHOUT LIMITATION, SATISFACTORY QUALITY OR ACCURACY OF DIMENSIONS.

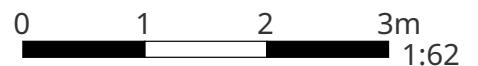

# 123 Springfield Drive

## Bathroom

Width: 2.51 m  
Length: 2.55 m  
Area: 5.25 m<sup>2</sup>  
Perimeter: 10.12 m

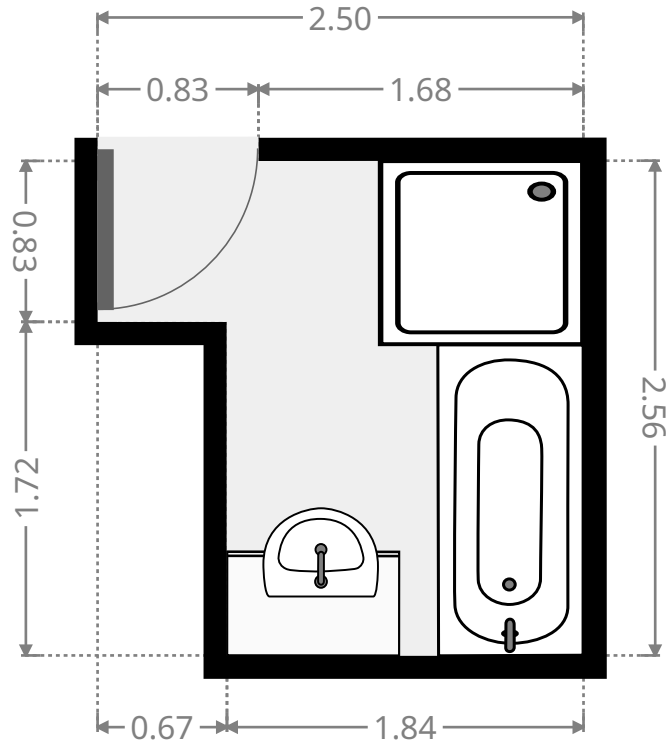
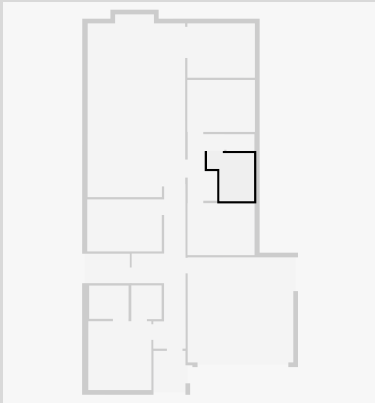

## Toilet / Half Bath

Width: 0.90 m  
Length: 1.49 m  
Area: 1.34 m<sup>2</sup>  
Perimeter: 4.78 m

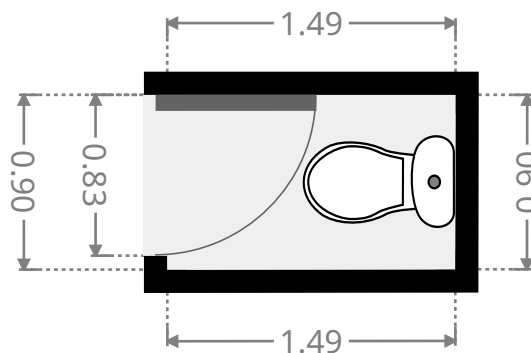
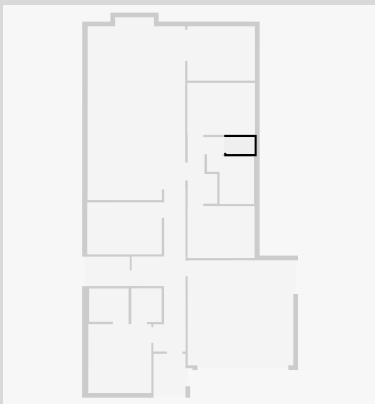

# 123 Springfield Drive

## Bedroom

Width: 2.77 m  
Length: 3.61 m  
Area: 9.99 m<sup>2</sup>  
Perimeter: 12.75 m

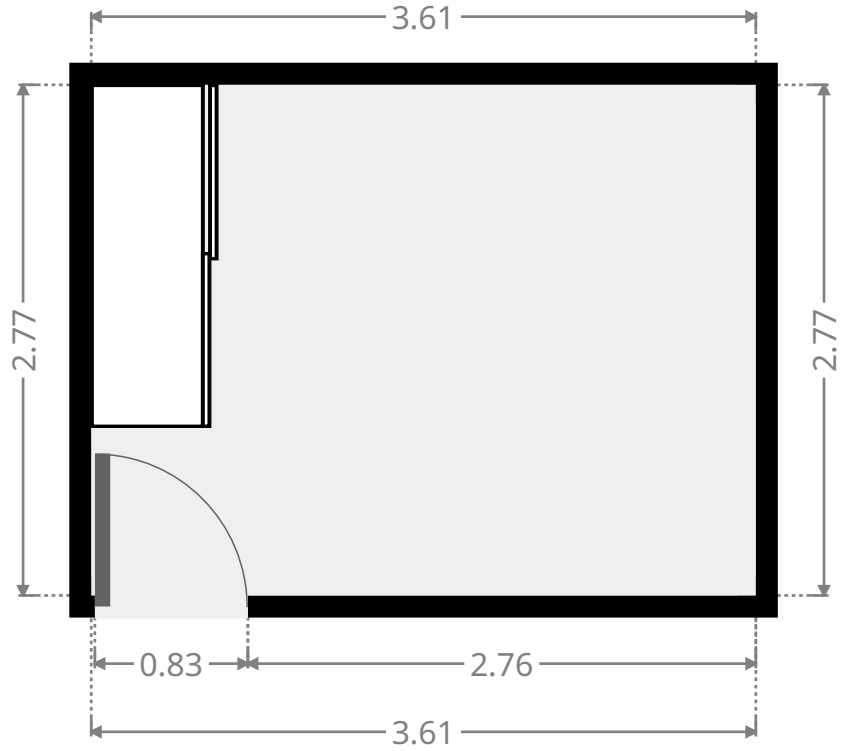
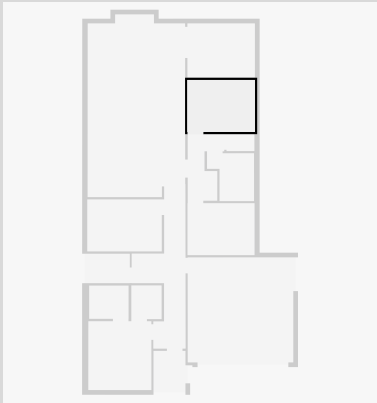

## Outdoor Area

Width: 2.90 m  
Length: 3.60 m  
Area: 10.42 m<sup>2</sup>  
Perimeter: 12.99 m

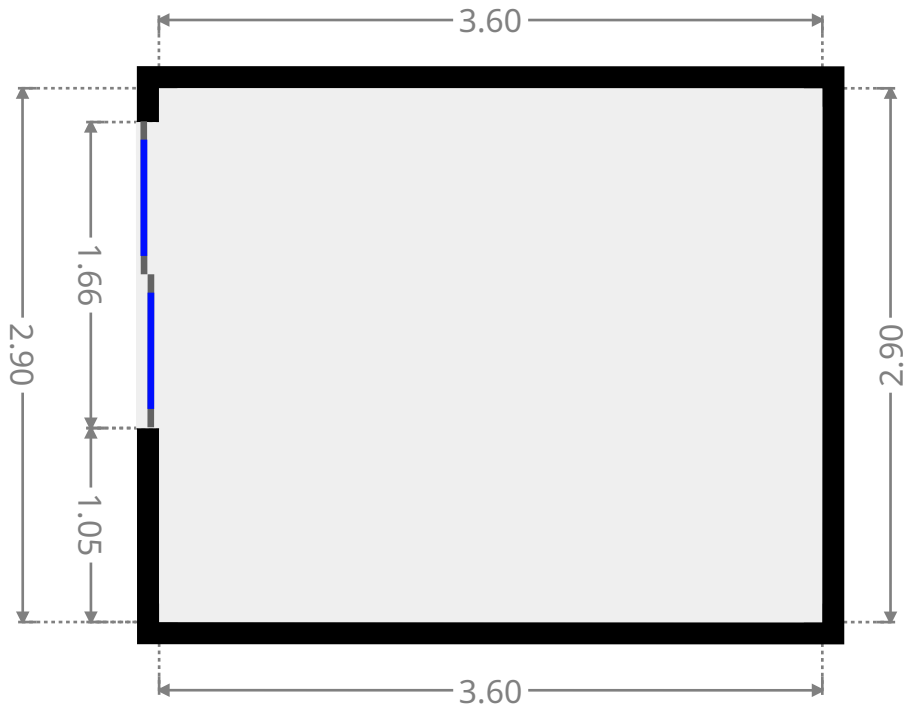
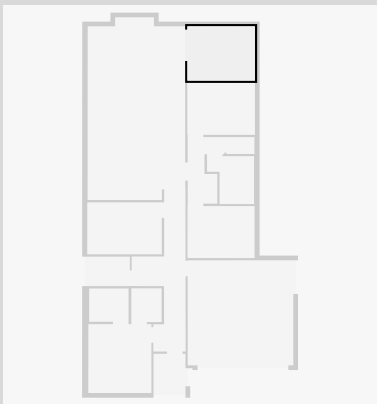



# 123 Springfield Drive

## Other

Width: 1.70 m  
Length: 2.09 m  
Area: 3.56 m<sup>2</sup>  
Perimeter: 7.59 m

