

121 Spike Street

SUBMITTED BY
Ray White Rockhampton Casey
stockers@cqoz.com

CREATED ON
2022-04-22

Floors
2

▼ Ground Floor

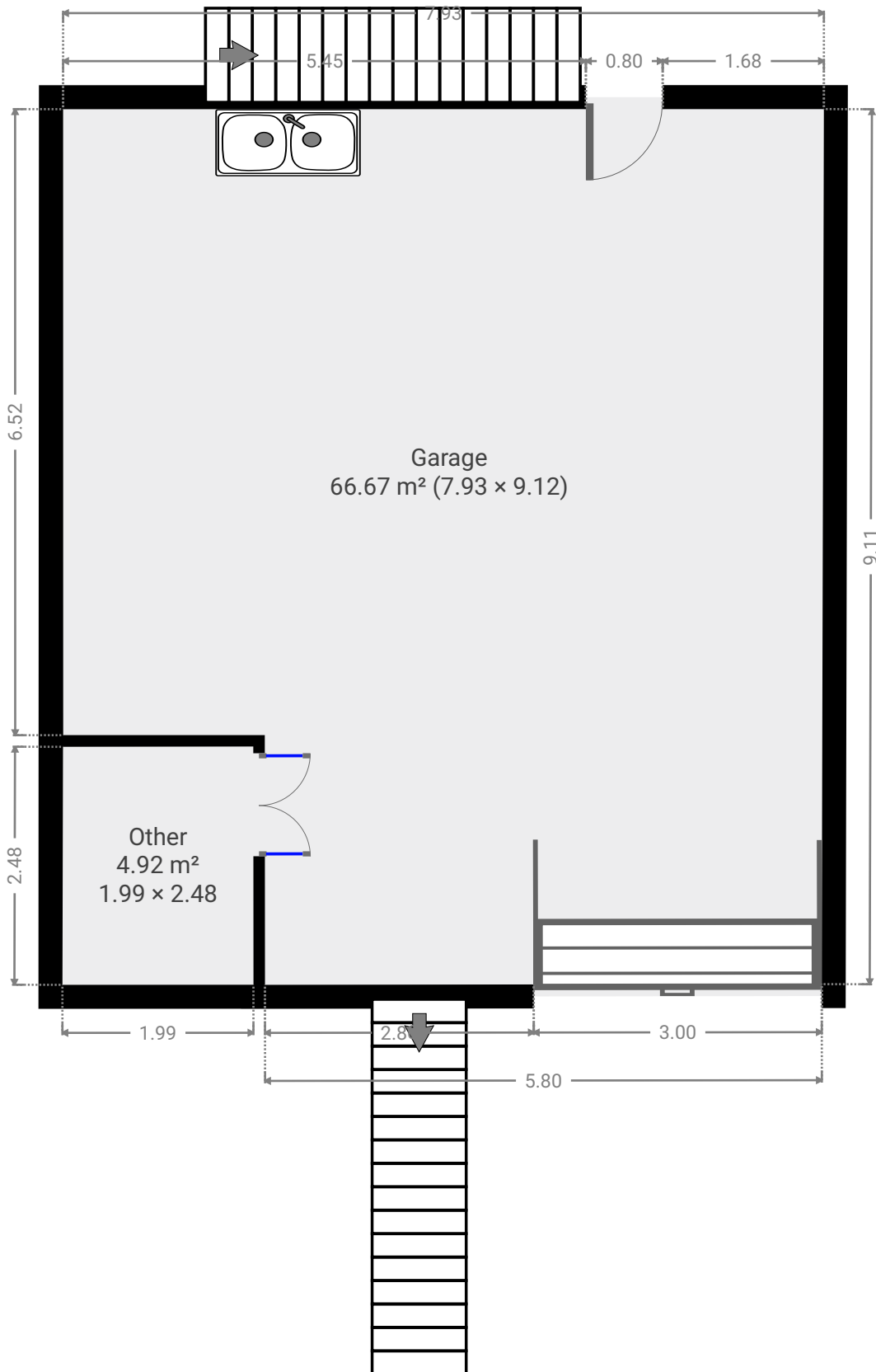

▼ 1st Floor

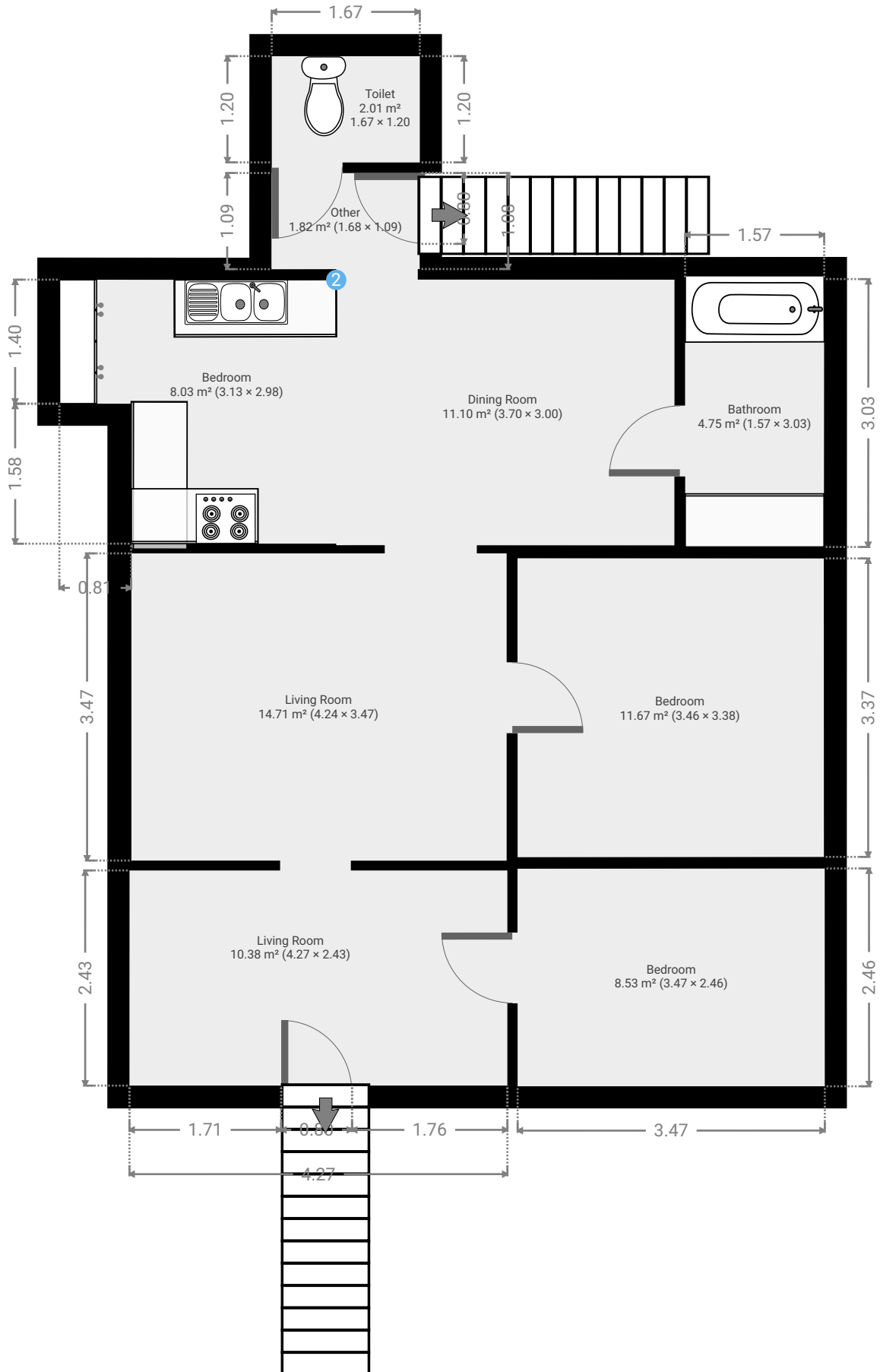

▼ **Living Room**
1st Floor

WIDTH: 4.27 m • LENGTH: 2.43 m
AREA: 10.38 m² • PERIMETER: 13.40 m

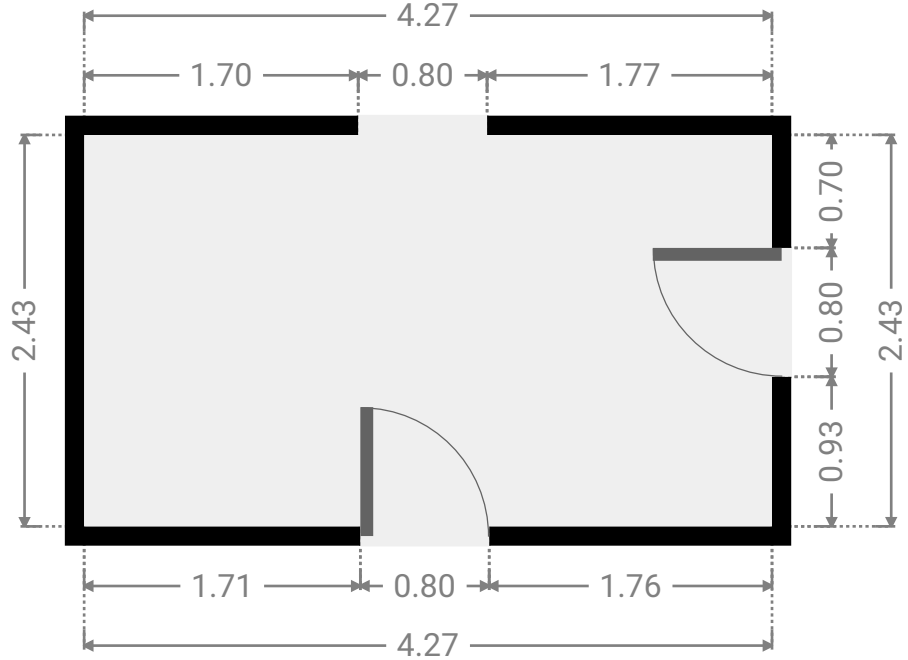
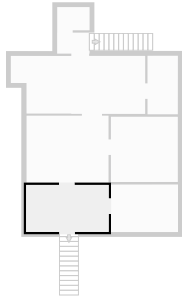

▼ **Bedroom**
1st Floor

WIDTH: 3.47 m • LENGTH: 2.46 m
AREA: 8.53 m² • PERIMETER: 11.86 m

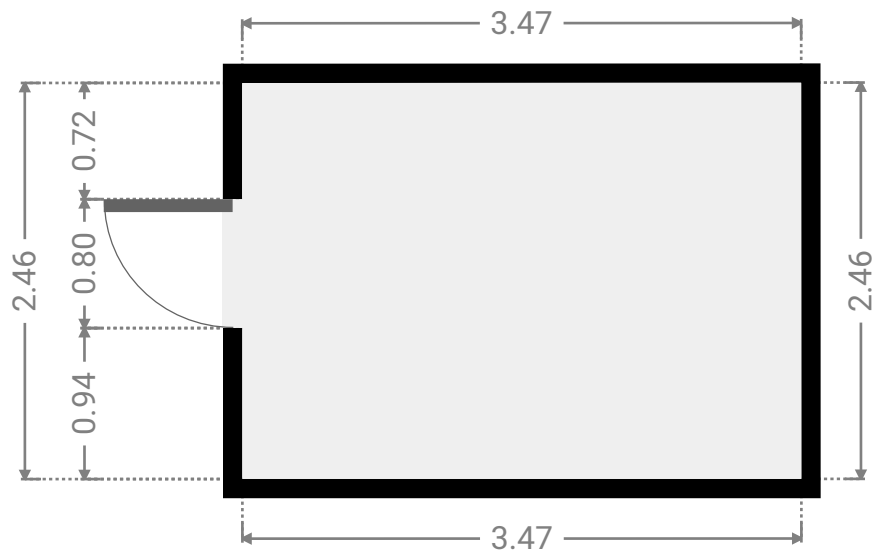
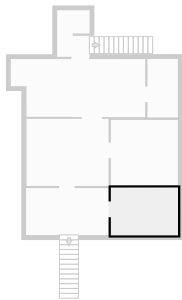

▼ Living Room
1st Floor

WIDTH: 4.24 m • LENGTH: 3.47 m
AREA: 14.71 m² • PERIMETER: 15.42 m

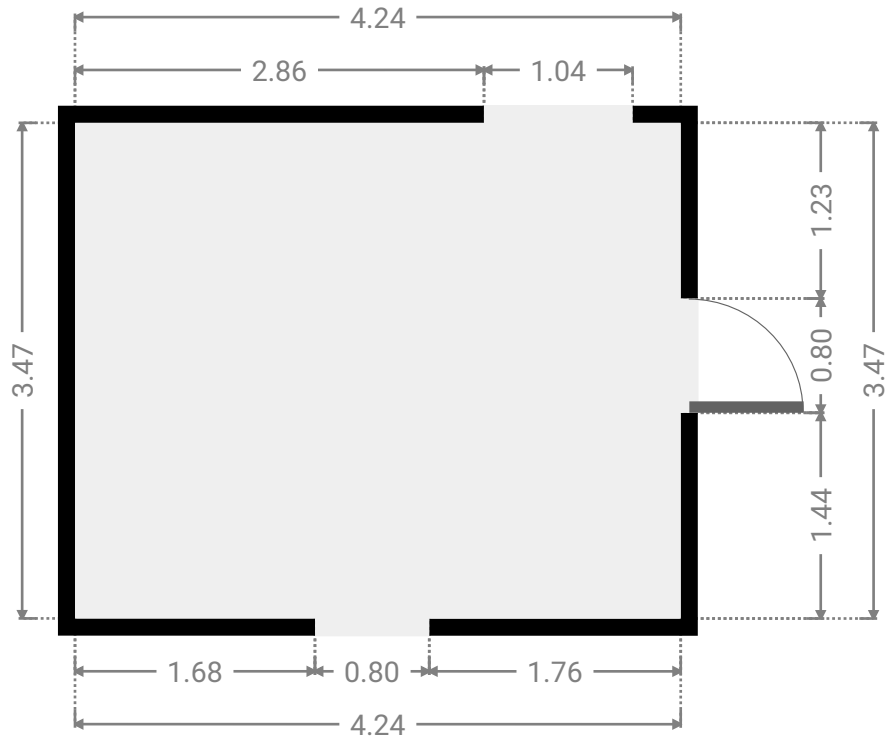
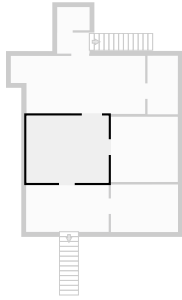

▼ Bedroom
1st Floor

WIDTH: 3.46 m • LENGTH: 3.38 m
AREA: 11.67 m² • PERIMETER: 13.67 m

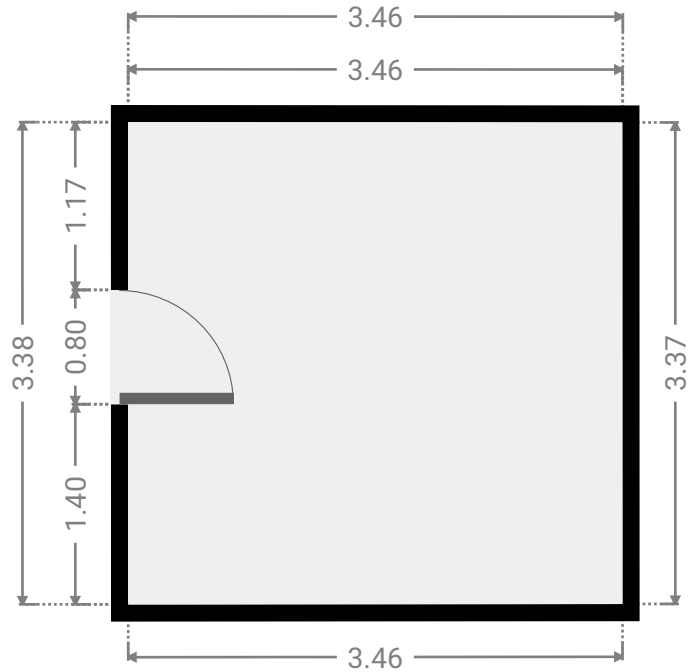
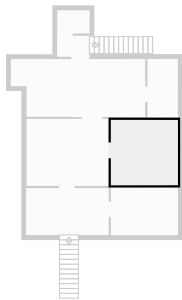

▼ **Dining Room**
1st Floor

WIDTH: 3.70 m • LENGTH: 3.00 m
AREA: 11.10 m² • PERIMETER: 13.40 m

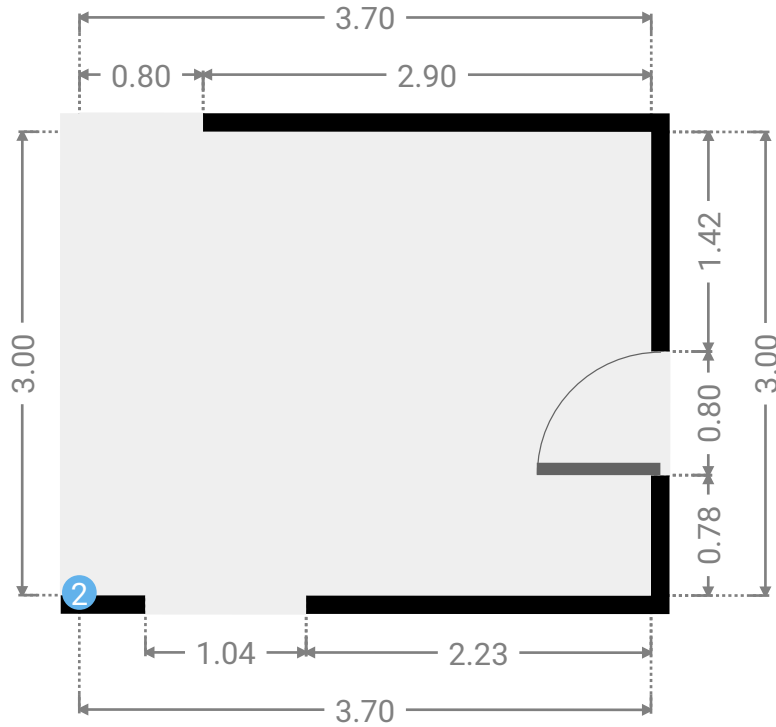
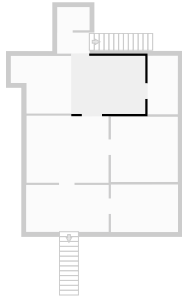

▼ **Bathroom**
1st Floor

WIDTH: 1.57 m • LENGTH: 3.03 m
AREA: 4.75 m² • PERIMETER: 9.19 m

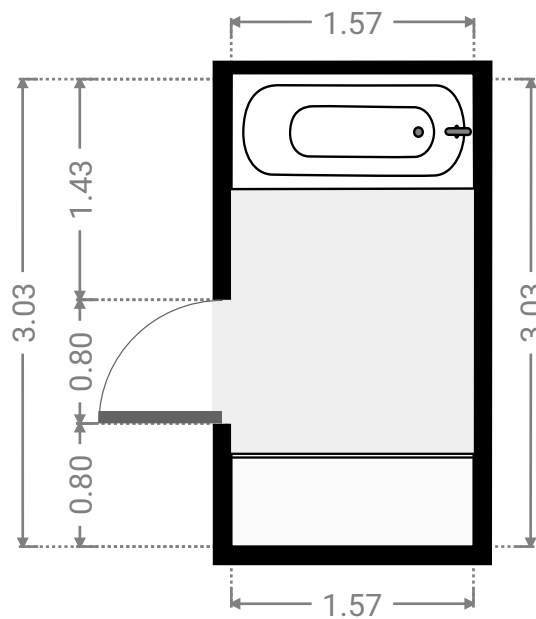
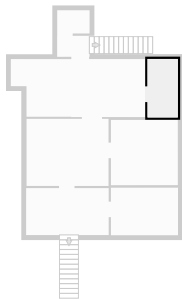

▼ **Bedroom**
1st Floor

WIDTH: 3.13 m • LENGTH: 2.98 m
AREA: 8.03 m² • PERIMETER: 12.21 m

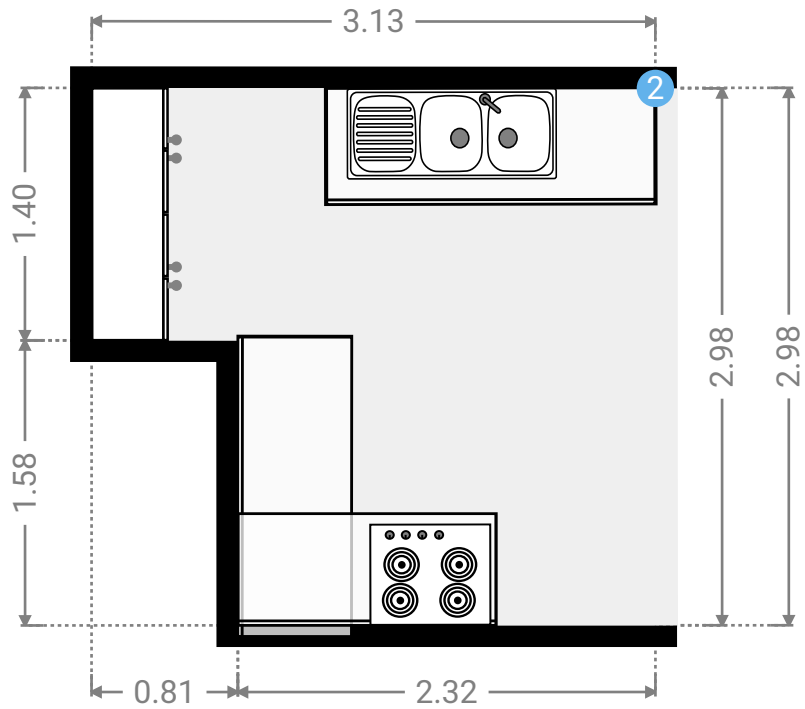
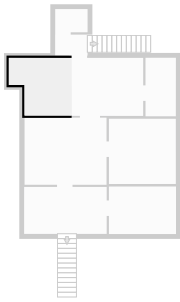

▼ **Bedroom/1st Floor**

2 OPENING

Height
0.00 m



▼ **Other**
1st Floor

WIDTH: 1.68 m • LENGTH: 1.09 m
AREA: 1.82 m² • PERIMETER: 5.52 m

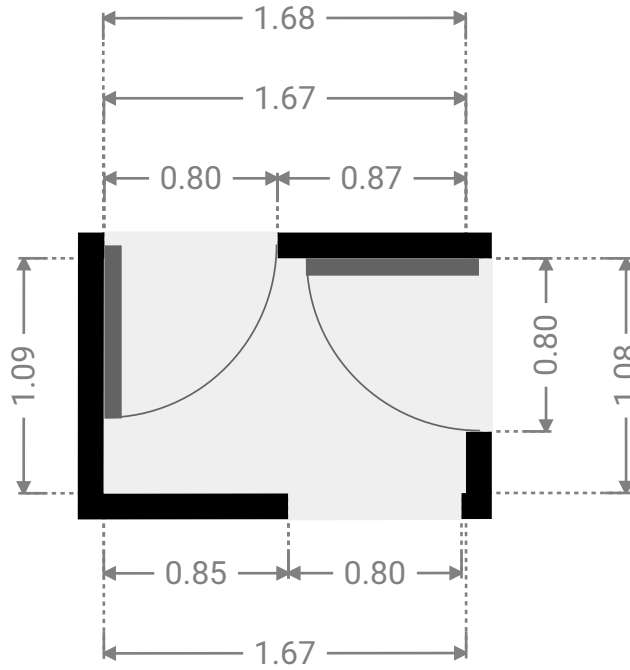
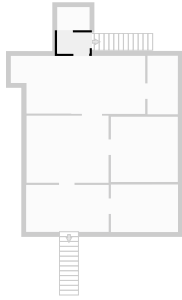

▼ **Toilet**
1st Floor

WIDTH: 1.67 m • LENGTH: 1.20 m
AREA: 2.01 m² • PERIMETER: 5.75 m

