

12 Waratah Court

Ground Floor

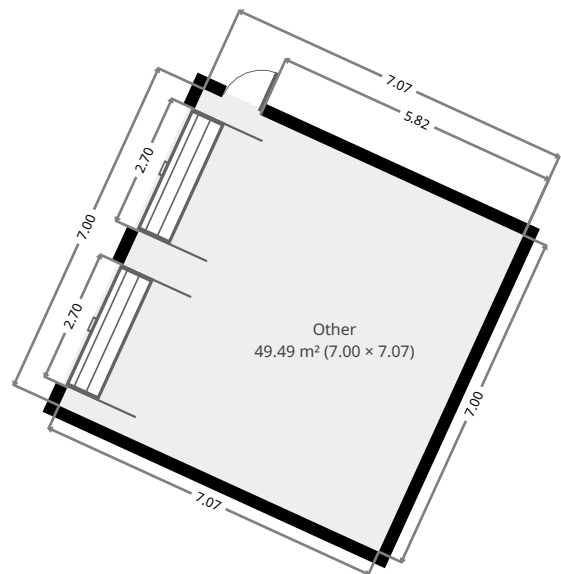

THIS FLOORPLAN IS PROVIDED WITHOUT WARRANTY OF ANY KIND. SENSOPIA DISCLAIMS ANY WARRANTY INCLUDING, WITHOUT LIMITATION, SATISFACTORY QUALITY OR ACCURACY OF DIMENSIONS.

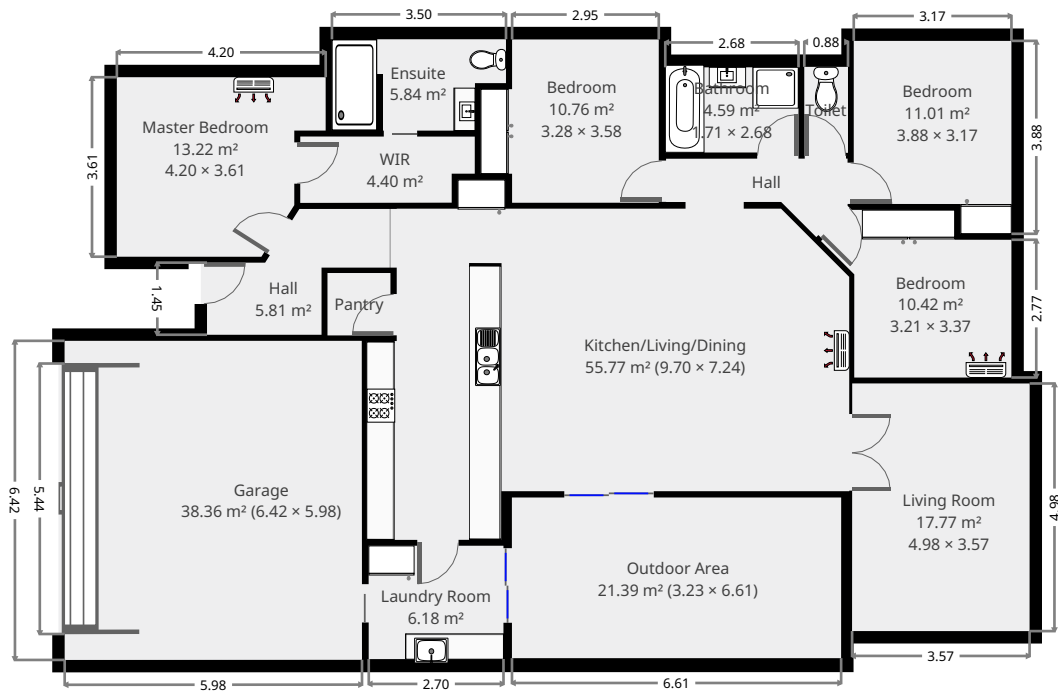

12 Waratah Court

Bathroom

Width: 1.71 m
Length: 2.68 m
Area: 4.59 m²
Perimeter: 8.78 m

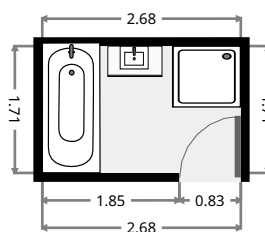
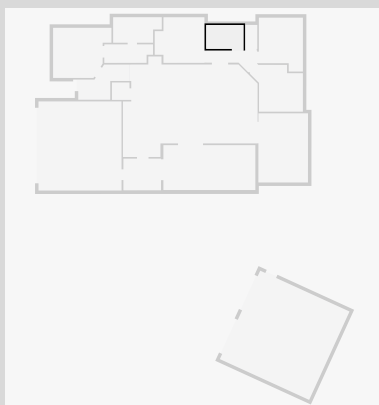

Other

Width: 7.00 m
Length: 7.07 m
Area: 49.49 m²
Perimeter: 28.14 m

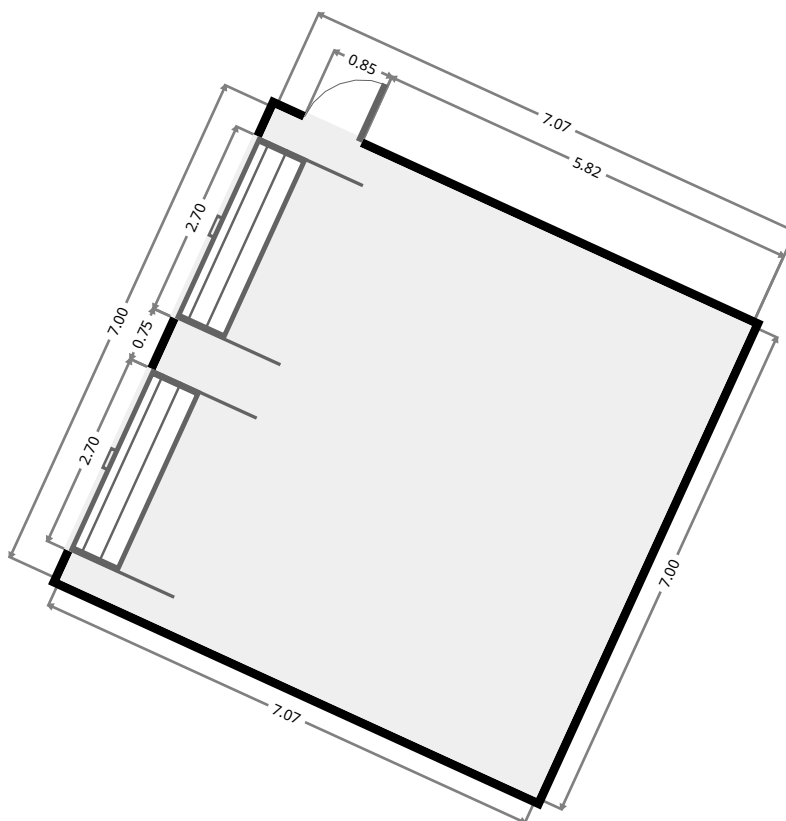
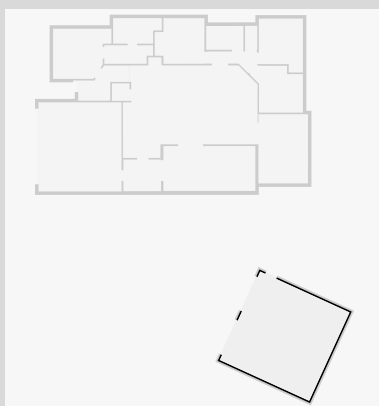

12 Waratah Court

Garage

Width: 5.98 m
 Length: 6.42 m
 Area: 38.36 m²
 Perimeter: 24.79 m

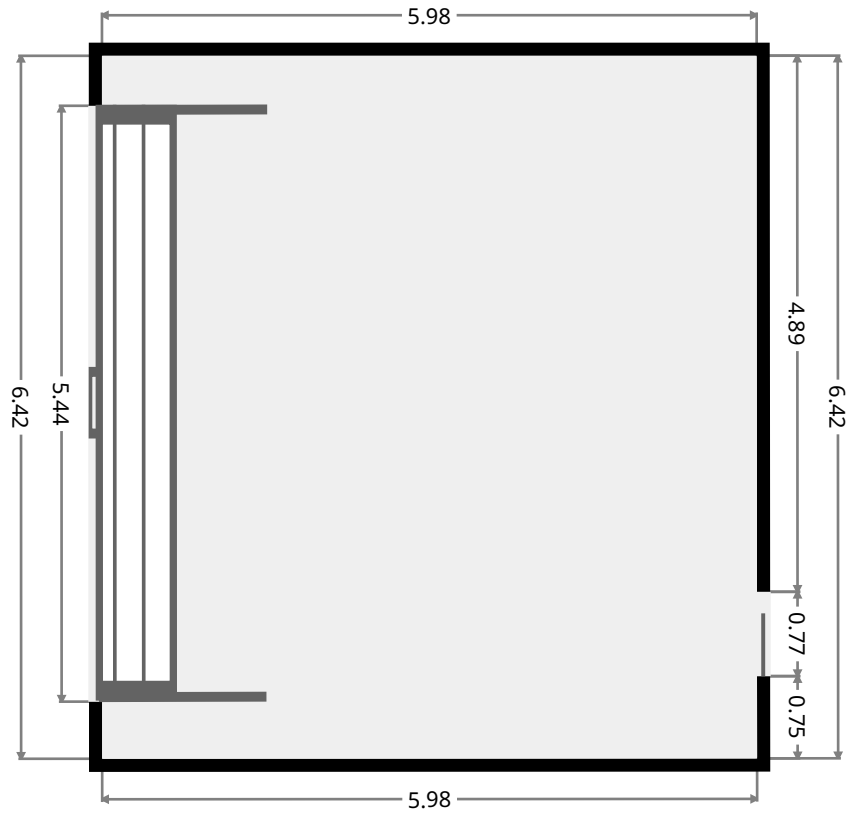
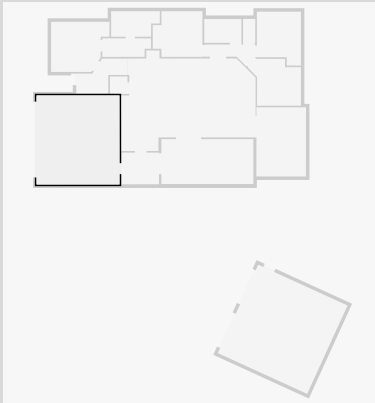

Laundry Room

Width: 2.28 m
 Length: 2.70 m
 Area: 6.18 m²
 Perimeter: 9.98 m

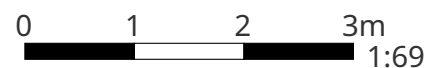
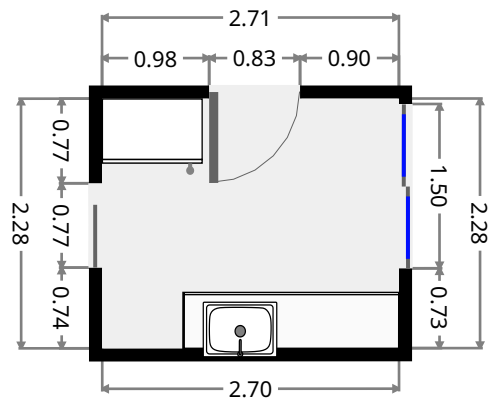
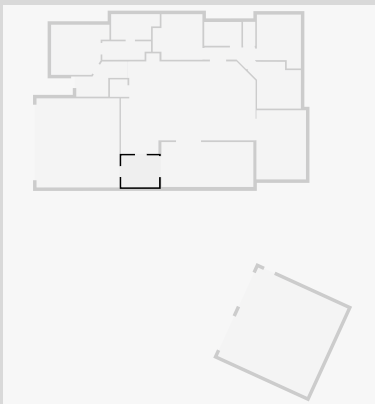

THIS FLOORPLAN IS PROVIDED WITHOUT WARRANTY OF ANY KIND. SENSOPIA DISCLAIMS ANY WARRANTY INCLUDING, WITHOUT LIMITATION, SATISFACTORY QUALITY OR ACCURACY OF DIMENSIONS.

12 Waratah Court

Outdoor Area

Width: 3.23 m
Length: 6.61 m
Area: 21.39 m²
Perimeter: 19.70 m

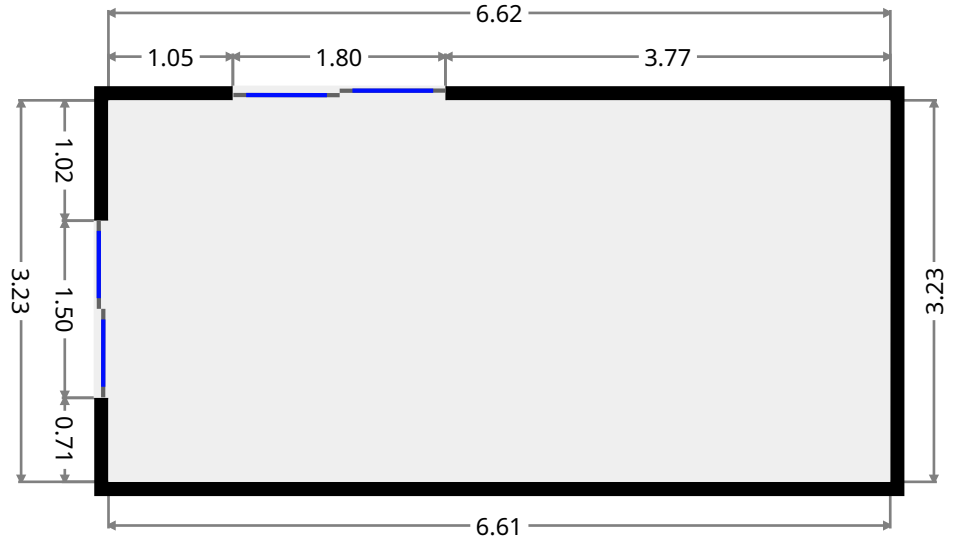
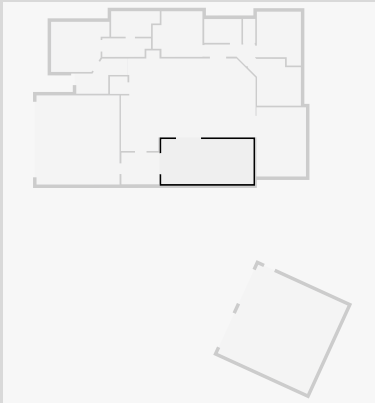

Ensuite

Width: 1.84 m
Length: 3.50 m
Area: 5.84 m²
Perimeter: 10.68 m

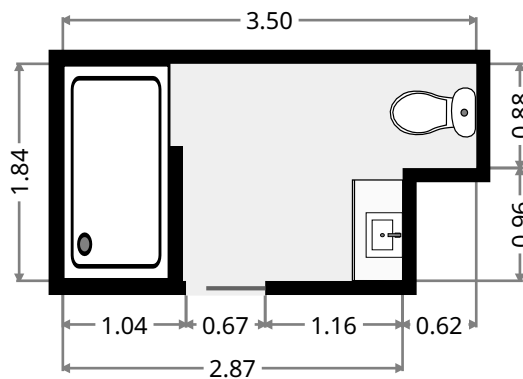
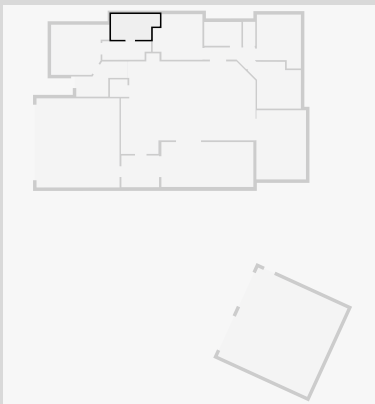

12 Waratah Court

WIR

Width: 1.34 m
 Length: 3.51 m
 Area: 4.40 m²
 Perimeter: 9.68 m

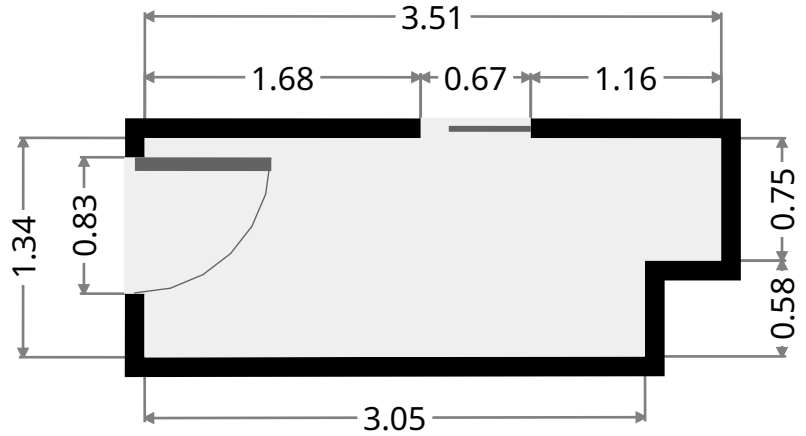
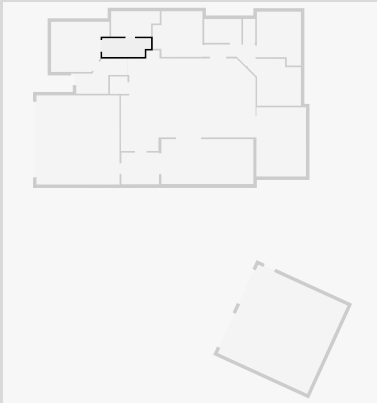

Master Bedroom

Width: 3.61 m
 Length: 4.20 m
 Area: 13.22 m²
 Perimeter: 15.15 m

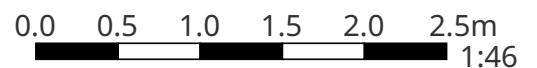
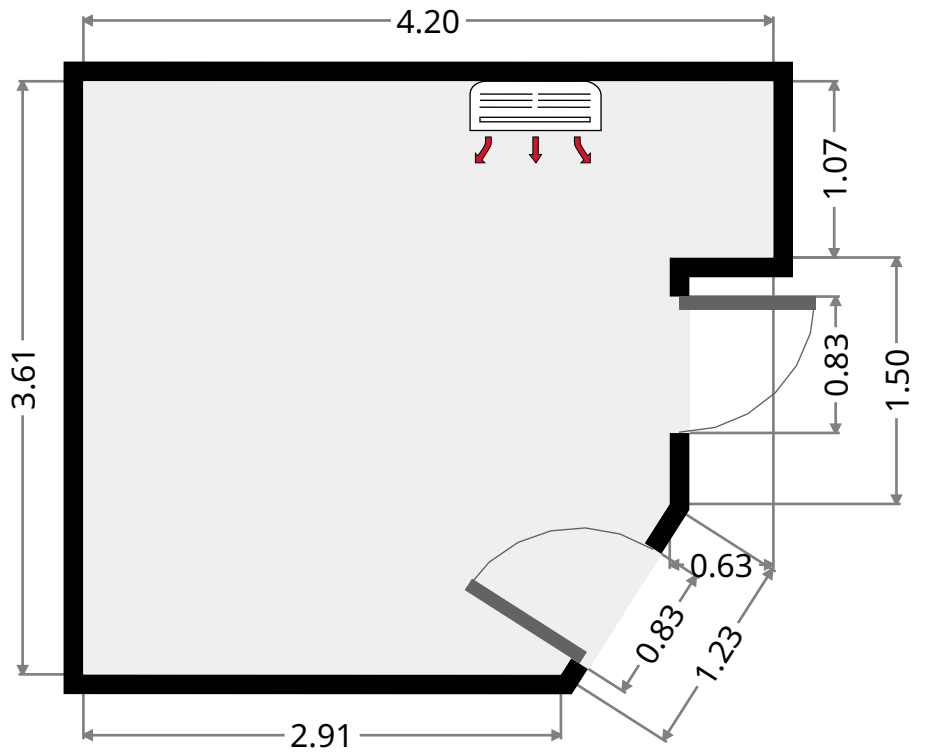
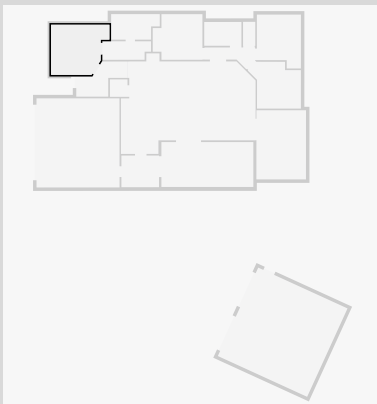

THIS FLOORPLAN IS PROVIDED WITHOUT WARRANTY OF ANY KIND. SENSOPIA DISCLAIMS ANY WARRANTY INCLUDING, WITHOUT LIMITATION, SATISFACTORY QUALITY OR ACCURACY OF DIMENSIONS.

12 Waratah Court

Bedroom

Width: 3.28 m
 Length: 3.58 m
 Area: 10.76 m²
 Perimeter: 13.73 m

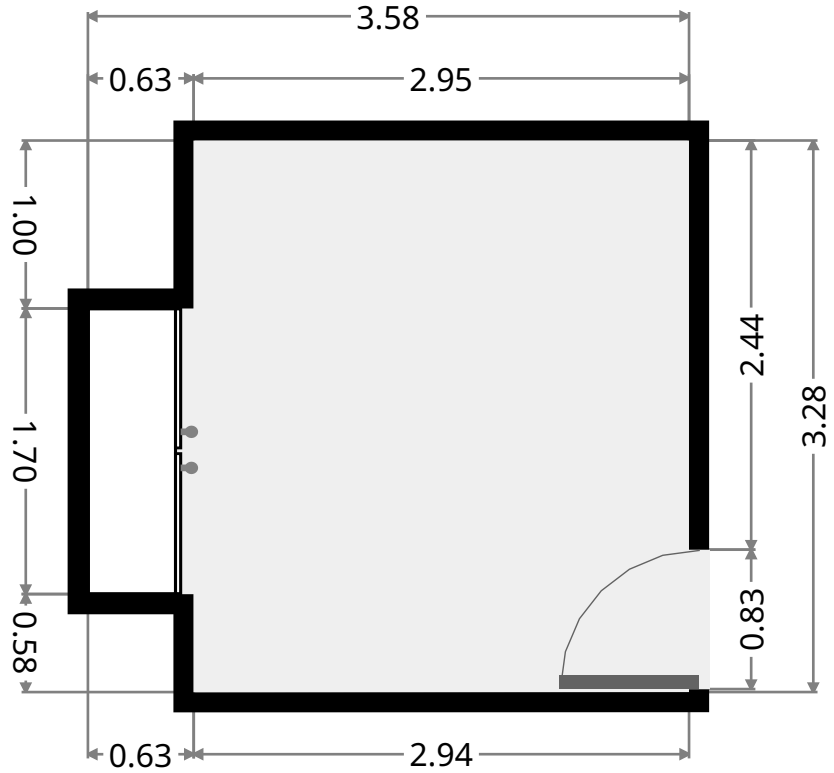
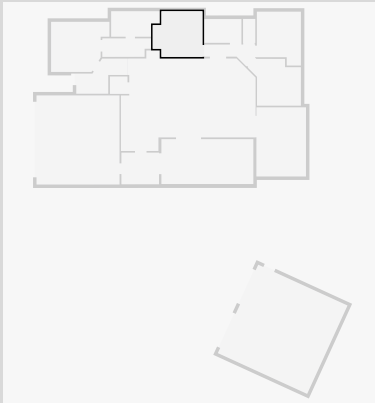

Hall

Width: 2.53 m
 Length: 3.68 m
 Area: 5.81 m²
 Perimeter: 11.93 m

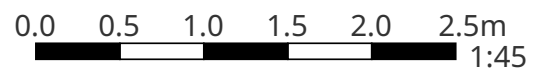
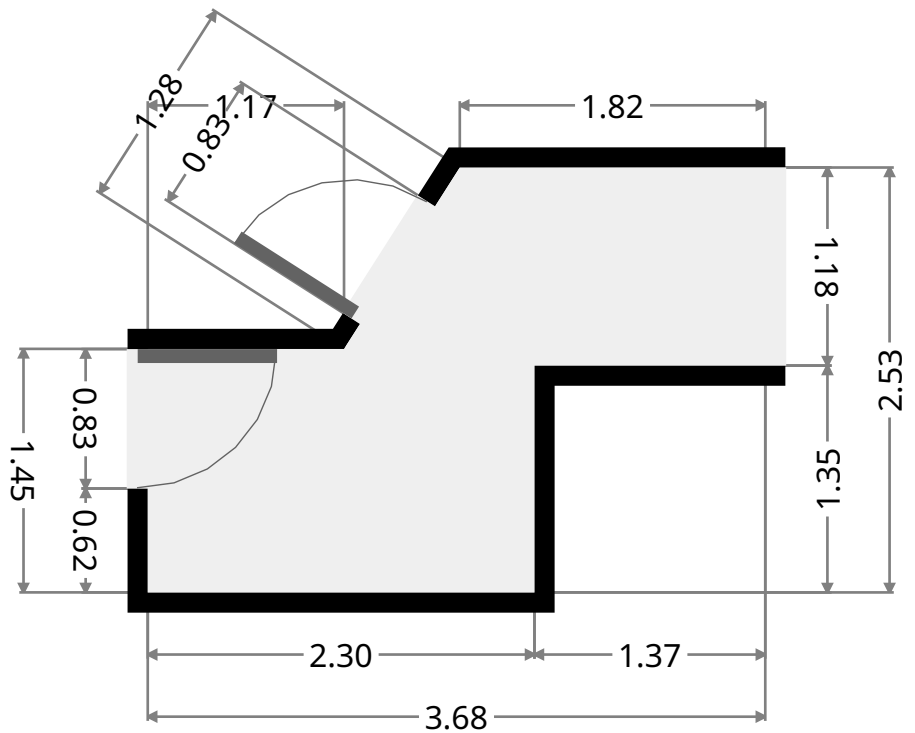
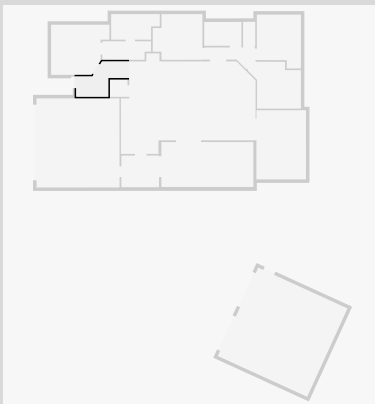

THIS FLOORPLAN IS PROVIDED WITHOUT WARRANTY OF ANY KIND. SENSOPIA DISCLAIMS ANY WARRANTY INCLUDING, WITHOUT LIMITATION, SATISFACTORY QUALITY OR ACCURACY OF DIMENSIONS.

12 Waratah Court

Toilet

Width: 0.88 m
 Length: 1.73 m
 Area: 1.52 m²
 Perimeter: 5.22 m

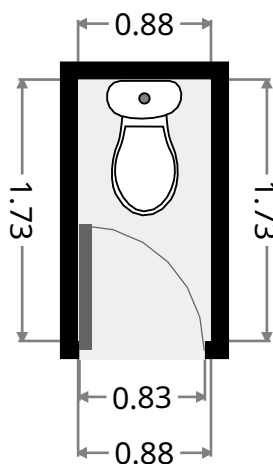
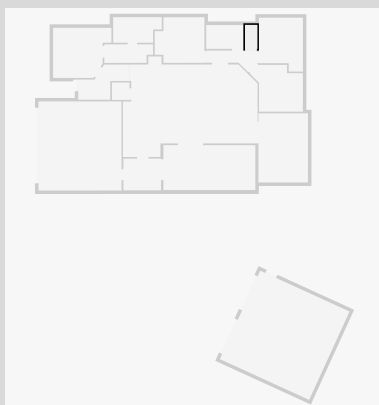

Bedroom

Width: 3.21 m
 Length: 3.37 m
 Area: 10.42 m²
 Perimeter: 13.64 m

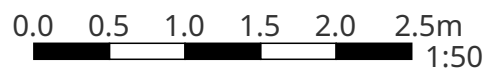
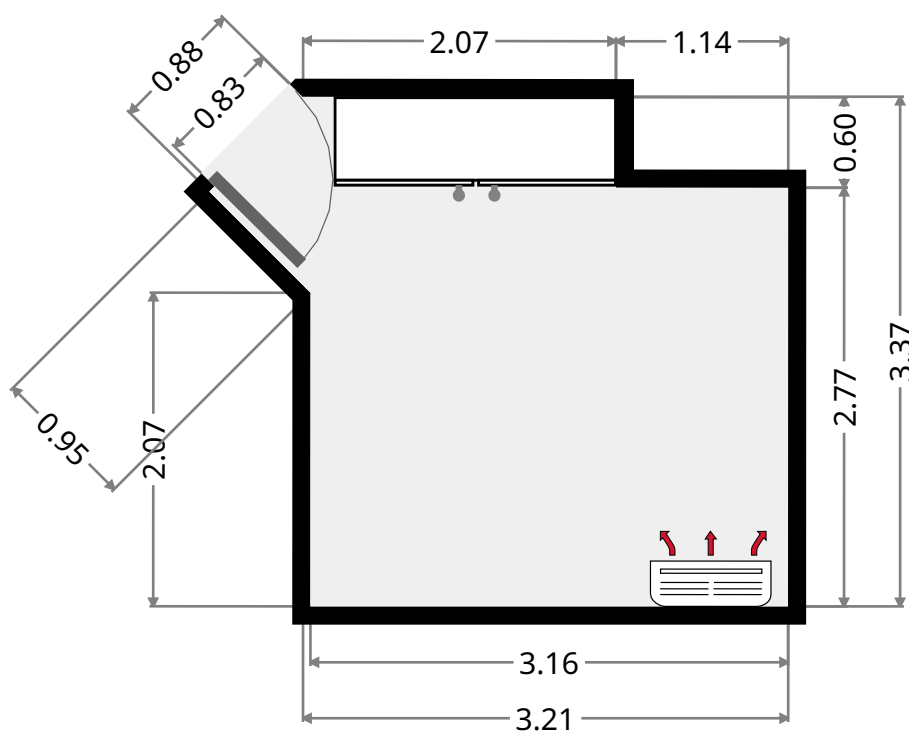
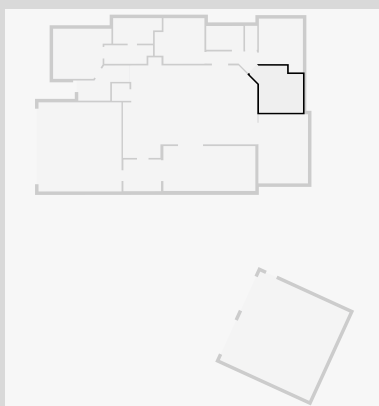

THIS FLOORPLAN IS PROVIDED WITHOUT WARRANTY OF ANY KIND. SENSOPIA DISCLAIMS ANY WARRANTY INCLUDING, WITHOUT LIMITATION, SATISFACTORY QUALITY OR ACCURACY OF DIMENSIONS.

12 Waratah Court

Bedroom

Width: 3.17 m
 Length: 3.88 m
 Area: 11.01 m²
 Perimeter: 14.10 m

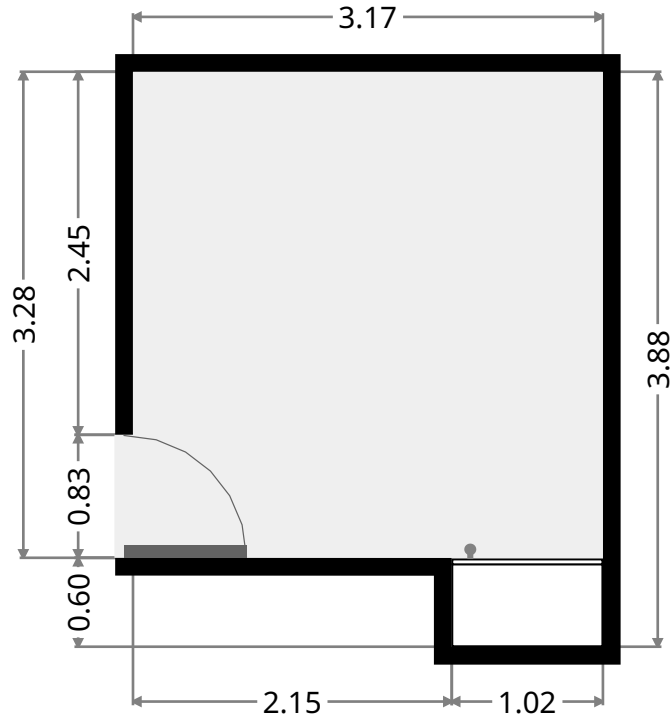
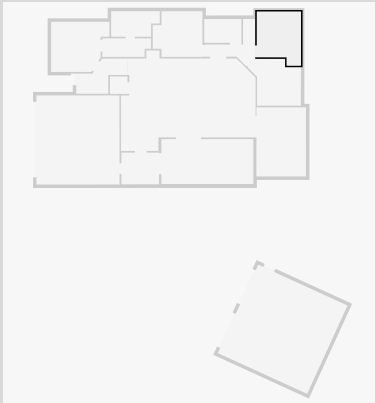

Hall

Width: 0.95 m
 Length: 3.65 m
 Area: 3.67 m²
 Perimeter: 9.67 m

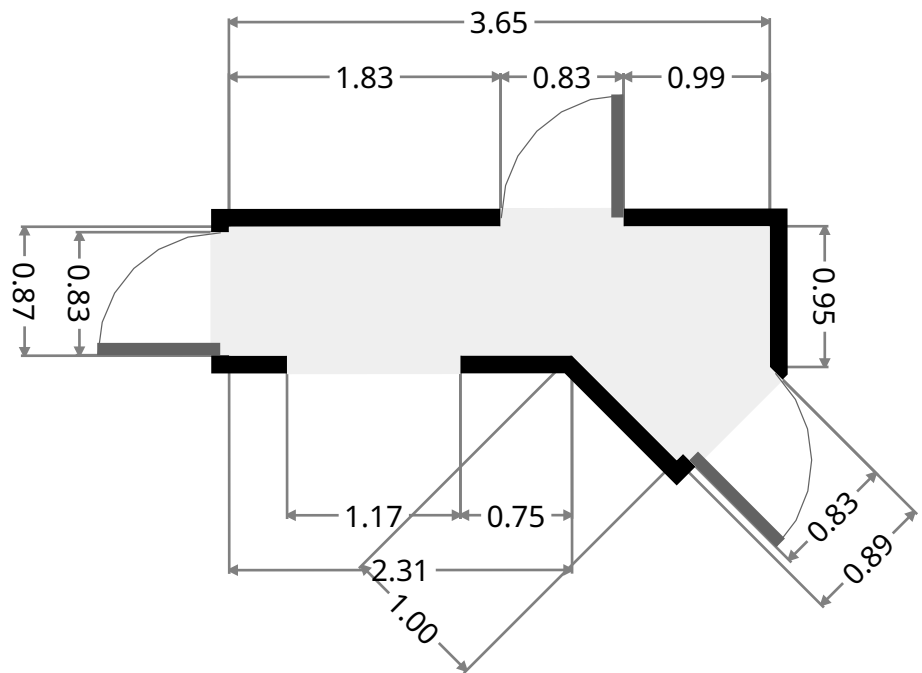
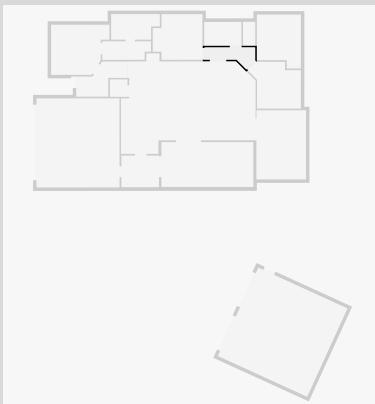

12 Waratah Court

Living Room

Width: 3.57 m
Length: 4.98 m
Area: 17.77 m²
Perimeter: 17.10 m

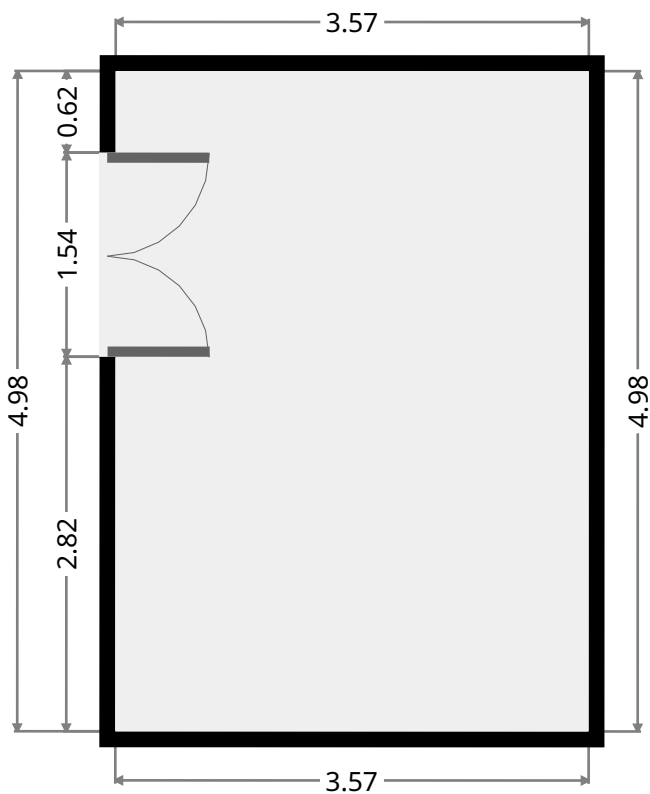
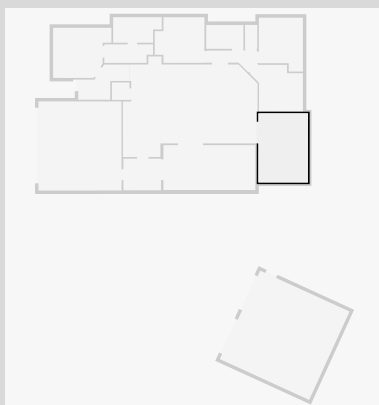

Pantry

Width: 1.25 m
Length: 1.27 m
Area: 1.59 m²
Perimeter: 5.04 m

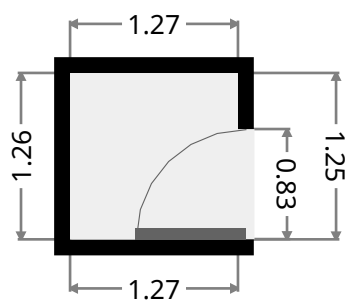
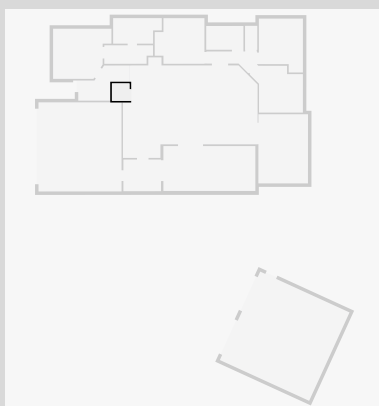

12 Waratah Court

Kitchen/Living/Dining

Width: 7.24 m
 Length: 9.70 m
 Area: 55.77 m²
 Perimeter: 33.08 m

