

# 12 Treefern Terrace

**SUBMITTED BY**

Ray White Rockhampton Casey  
stockers@cqoz.com

---

**CREATED ON**

2022-06-01

---

**Floors**

1

---

## ▼ Ground Floor

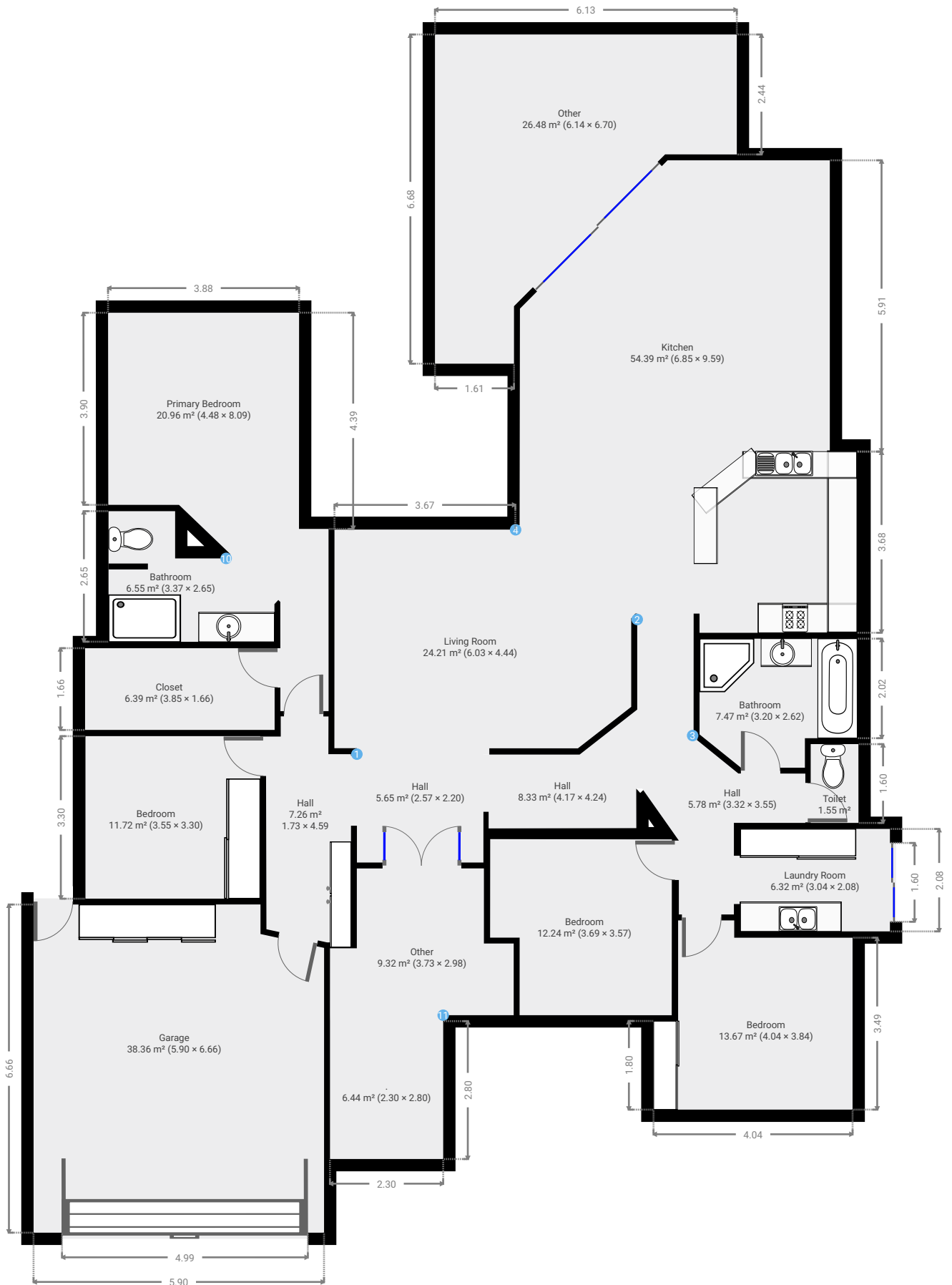

FLOORS: 1

## ▼ Ground Floor

WIDTH: 2.30 m • LENGTH: 2.80 m  
AREA: 6.44 m<sup>2</sup> • PERIMETER: 10.20 m

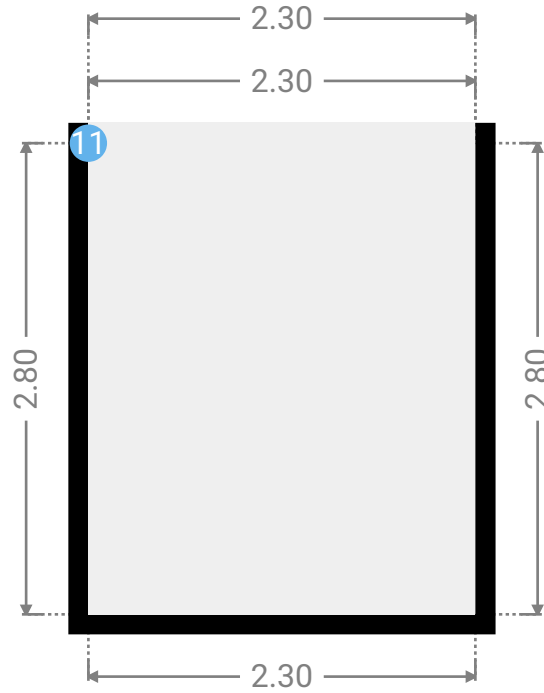
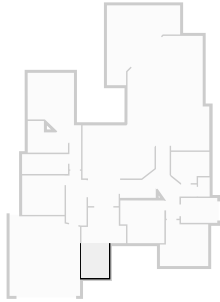

## ▼ Bathroom Ground Floor

WIDTH: 3.20 m • LENGTH: 2.62 m  
AREA: 7.47 m<sup>2</sup> • PERIMETER: 11.20 m

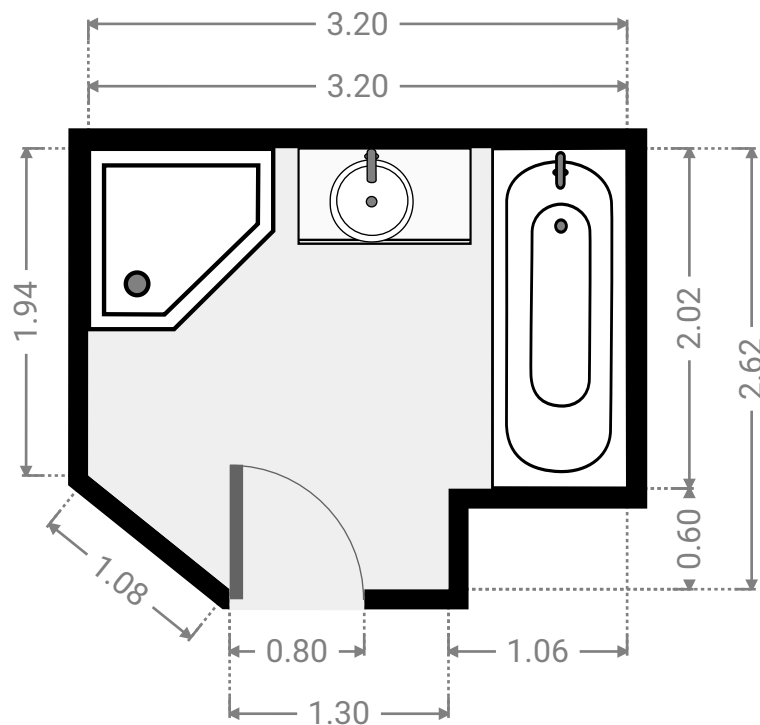
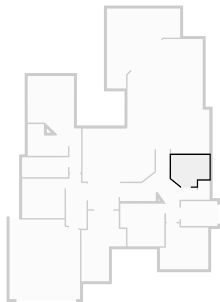

▼ **Bathroom**  
Ground Floor

WIDTH: 3.37 m • LENGTH: 2.65 m  
AREA: 6.55 m<sup>2</sup> • PERIMETER: 11.48 m

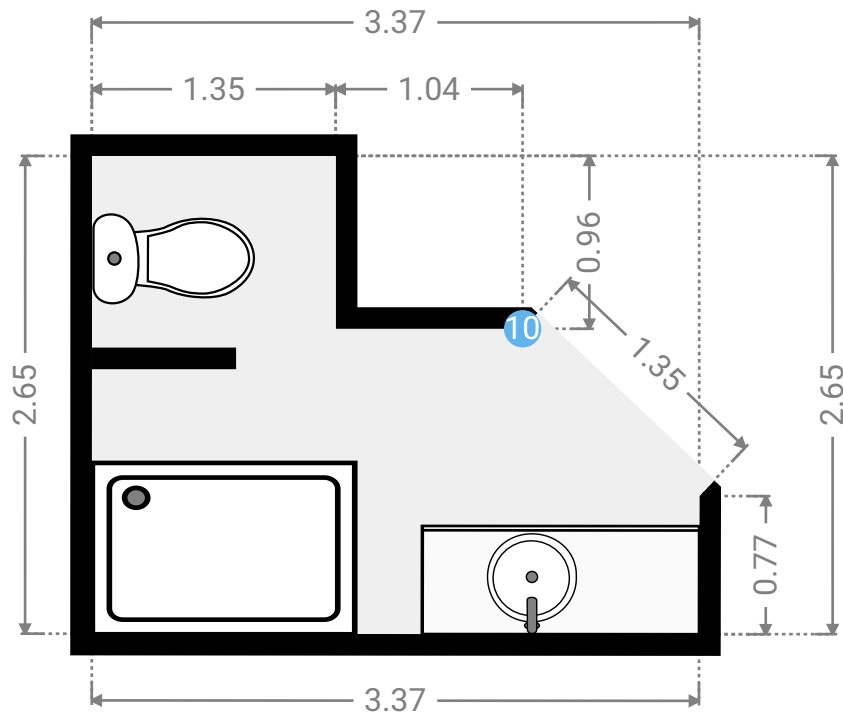
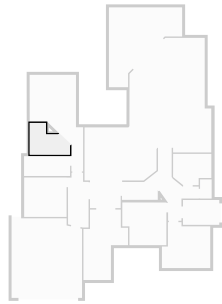

▼ **Bathroom/Ground Floor**

**10 OPENING**

Height  
0.00 m



FLOORS: 1

▼ **Bedroom**  
Ground Floor

WIDTH: 3.69 m • LENGTH: 3.57 m  
AREA: 12.24 m<sup>2</sup> • PERIMETER: 14.52 m

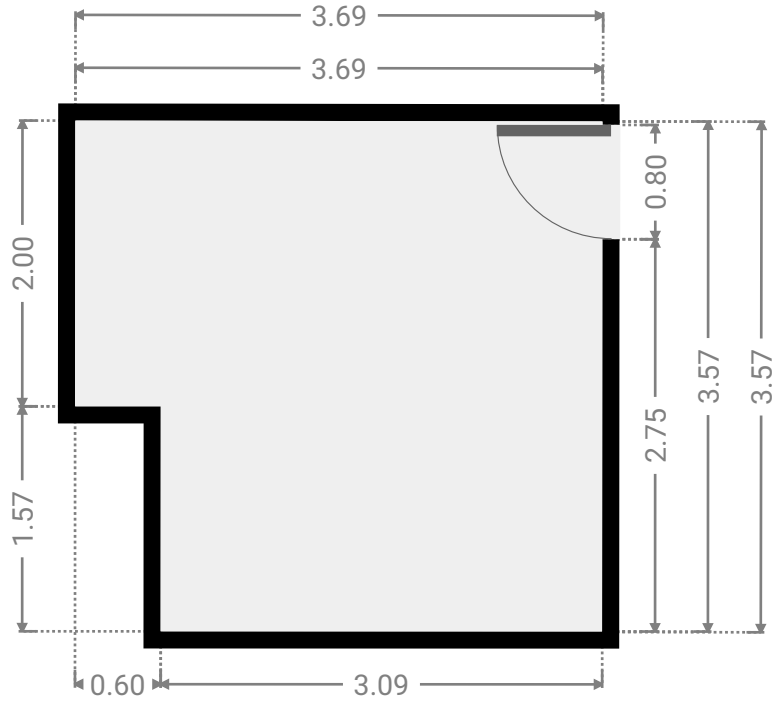
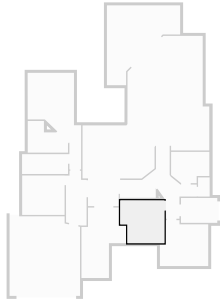

▼ **Bedroom**  
Ground Floor

WIDTH: 4.04 m • LENGTH: 3.84 m  
AREA: 13.67 m<sup>2</sup> • PERIMETER: 15.77 m

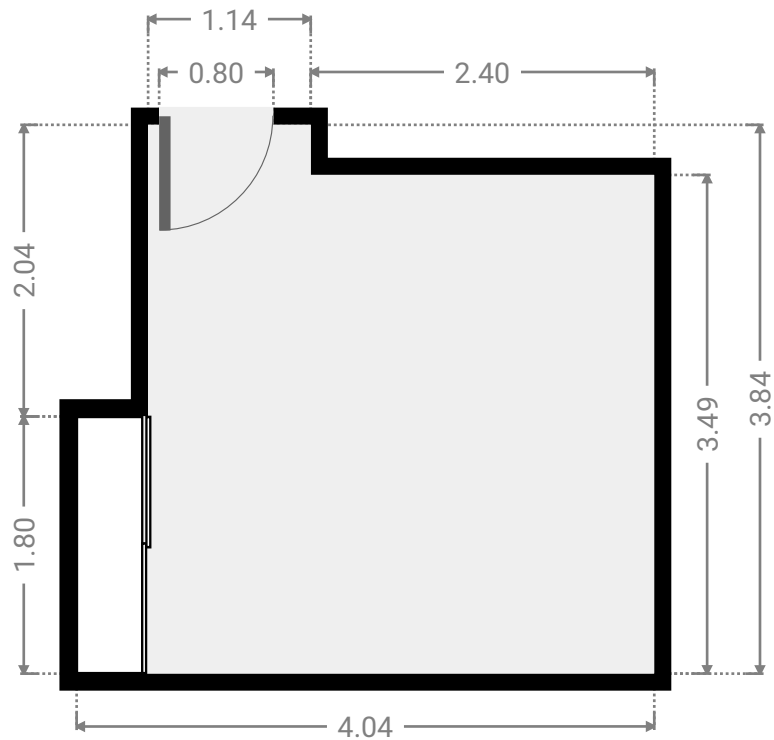
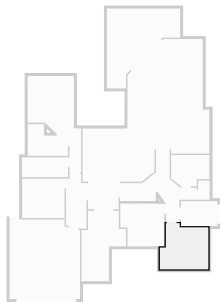

# 12 Treefern Terrace

FLOORS: 1



## ▼ Bedroom Ground Floor

WIDTH: 3.55 m • LENGTH: 3.30 m  
AREA: 11.72 m<sup>2</sup> • PERIMETER: 13.70 m

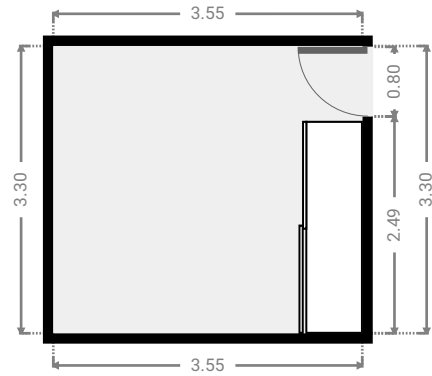
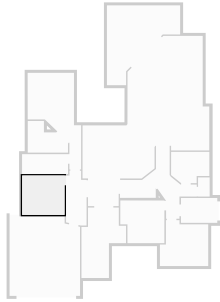

## ▼ Garage Ground Floor

WIDTH: 5.90 m • LENGTH: 6.66 m  
AREA: 38.36 m<sup>2</sup> • PERIMETER: 24.88 m

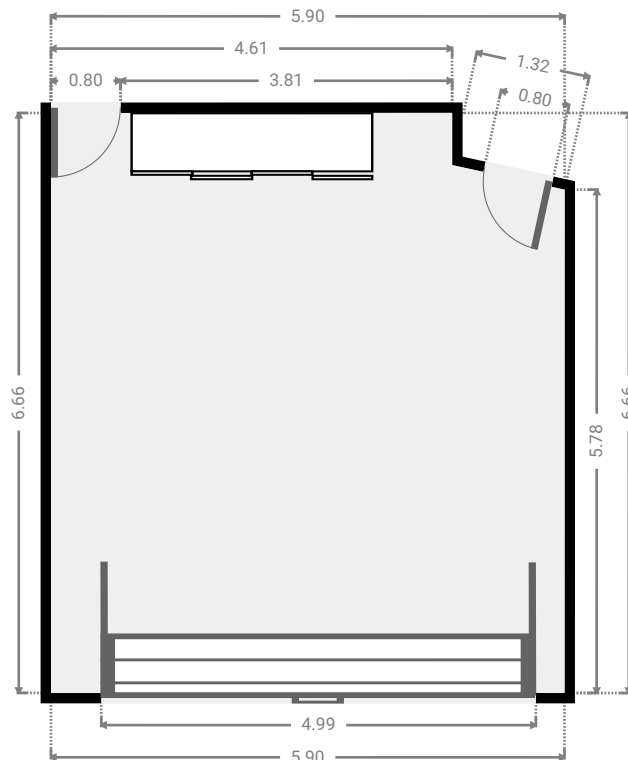
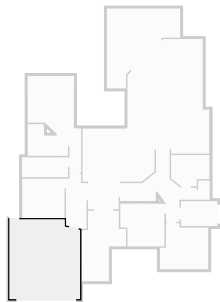

THIS FLOORPLAN IS PROVIDED WITHOUT WARRANTY OF ANY KIND. SENSOPIA DISCLAIMS ANY WARRANTY INCLUDING, WITHOUT LIMITATION, SATISFACTORY QUALITY OR ACCURACY OF DIMENSIONS.

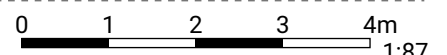

## ▼ Hall Ground Floor

WIDTH: 2.57 m • LENGTH: 2.20 m  
AREA: 5.65 m<sup>2</sup> • PERIMETER: 9.54 m

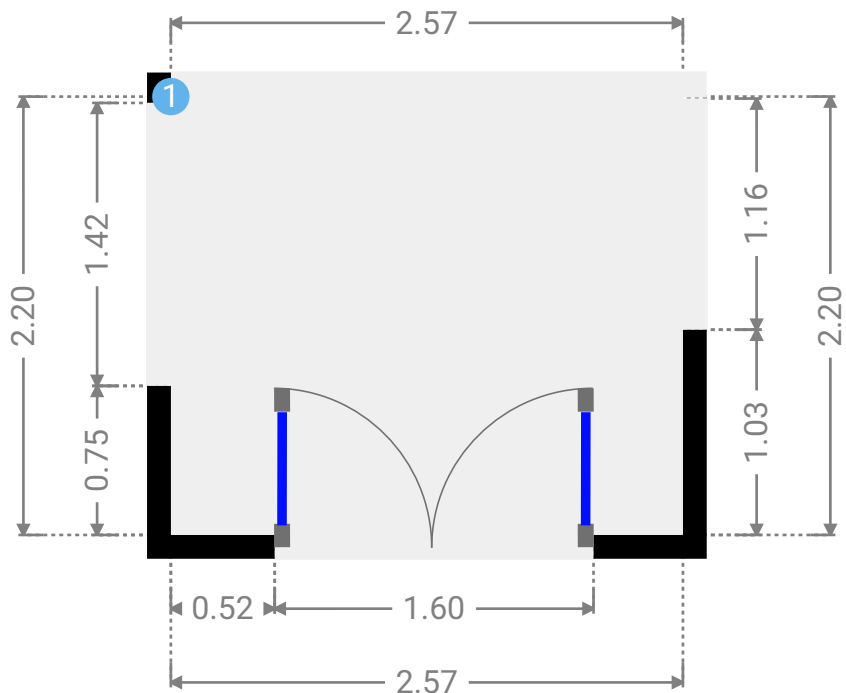
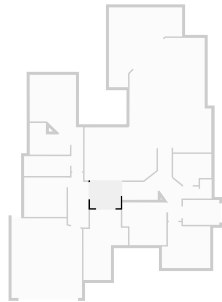

## ▼ Hall/Ground Floor

### 1 OPENING

Height  
0.00 m



FLOORS: 1

▼ **Hall**  
Ground Floor

WIDTH: 4.17 m • LENGTH: 4.24 m  
AREA: 8.33 m<sup>2</sup> • PERIMETER: 15.55 m

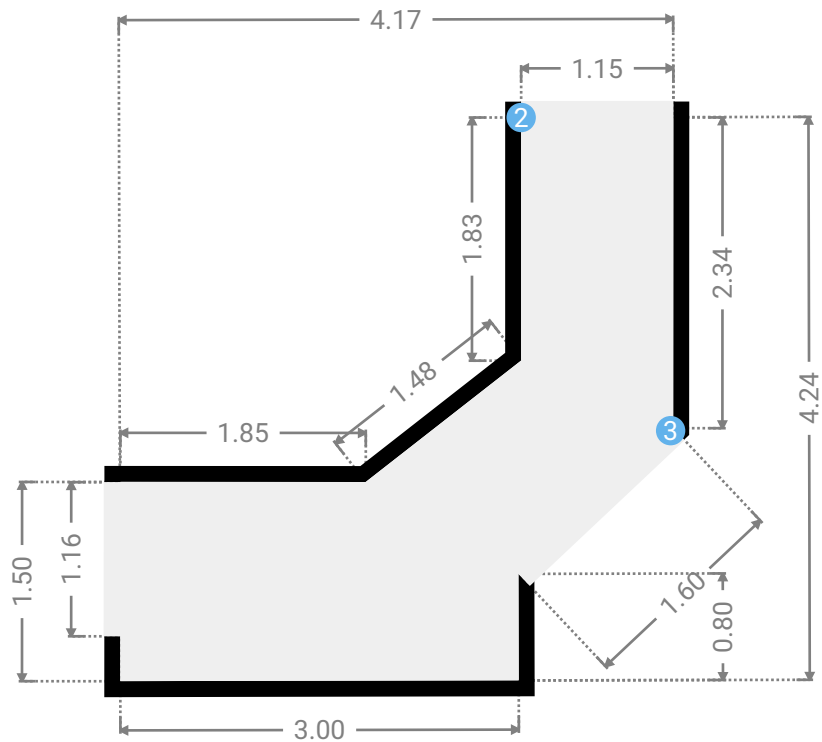
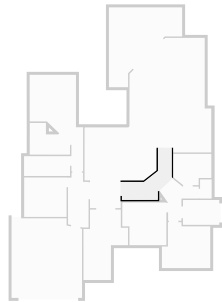

▼ **Hall/**Ground Floor

2 **OPENING**

Height  
0.00 m



3 **OPENING**

Height  
0.00 m





FLOORS: 1

## ▼ Hall Ground Floor

WIDTH: 3.32 m • LENGTH: 3.55 m  
AREA: 5.78 m<sup>2</sup> • PERIMETER: 12.17 m

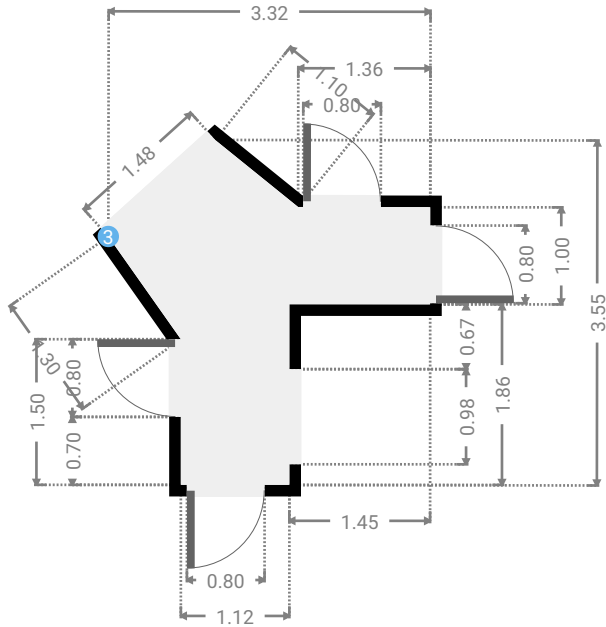
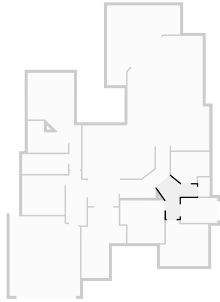

## ▼ Hall Ground Floor

WIDTH: 1.73 m • LENGTH: 4.59 m  
AREA: 7.26 m<sup>2</sup> • PERIMETER: 12.38 m

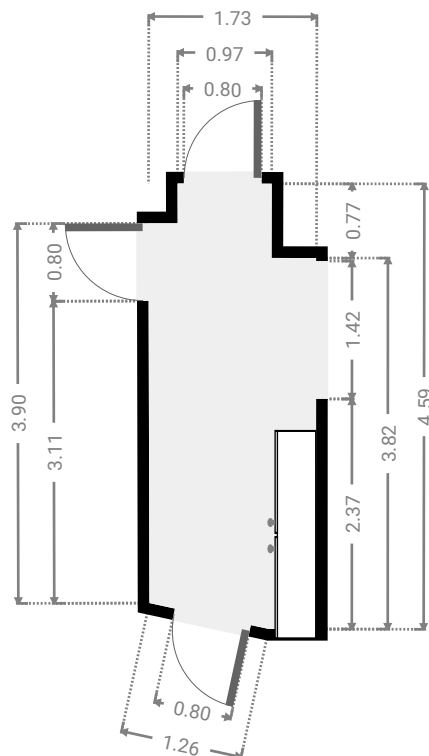
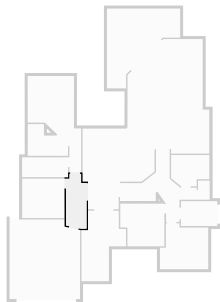

FLOORS: 1

## ▼ Kitchen Ground Floor

WIDTH: 6.85 m • LENGTH: 9.59 m  
AREA: 54.39 m<sup>2</sup> • PERIMETER: 29.93 m

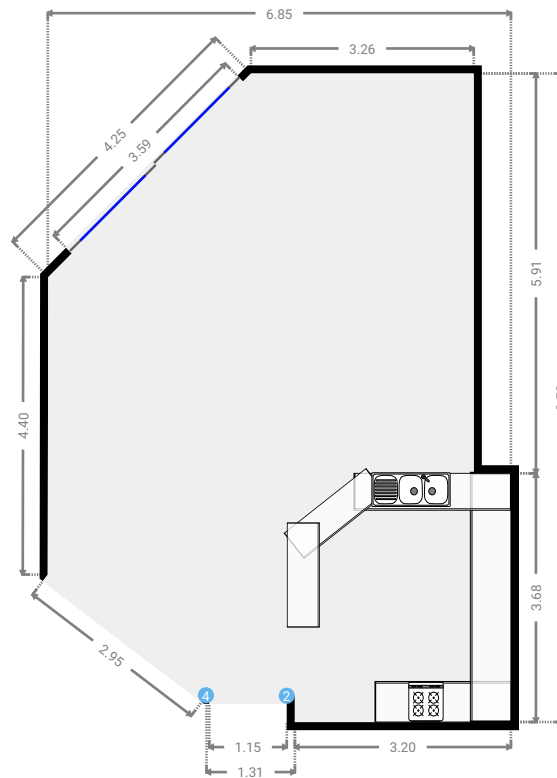
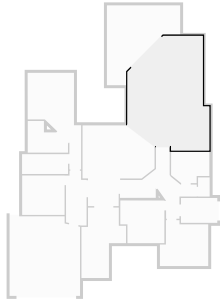

## ▼ Laundry Room Ground Floor

WIDTH: 3.04 m • LENGTH: 2.08 m  
AREA: 6.32 m<sup>2</sup> • PERIMETER: 10.24 m

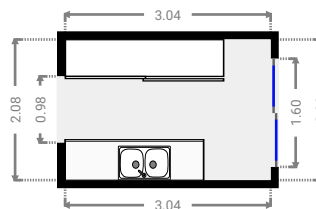
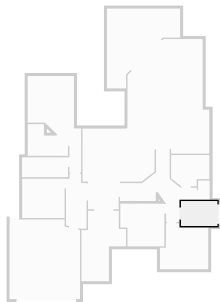

## ▼ Living Room Ground Floor

WIDTH: 6.03 m • LENGTH: 4.44 m  
AREA: 24.21 m<sup>2</sup> • PERIMETER: 19.20 m

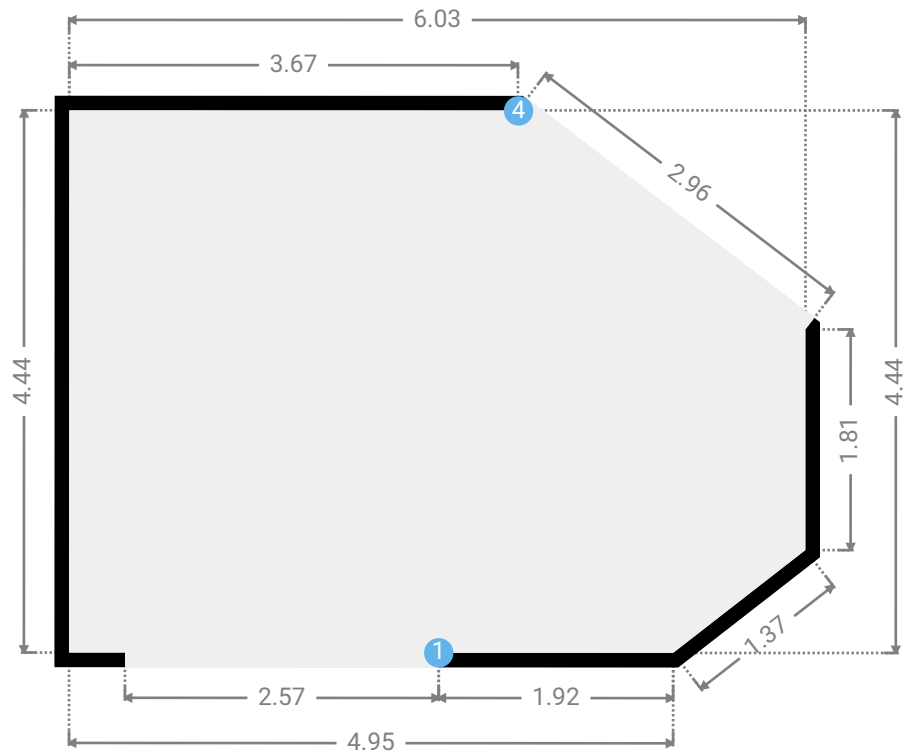
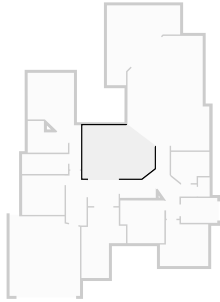

## ▼ Living Room/Ground Floor

### 4 OPENING

Height  
0.00 m



# 12 Treefern Terrace

FLOORS: 1



## ▼ Other Ground Floor

WIDTH: 6.14 m • LENGTH: 6.70 m  
AREA: 26.48 m<sup>2</sup> • PERIMETER: 23.83 m

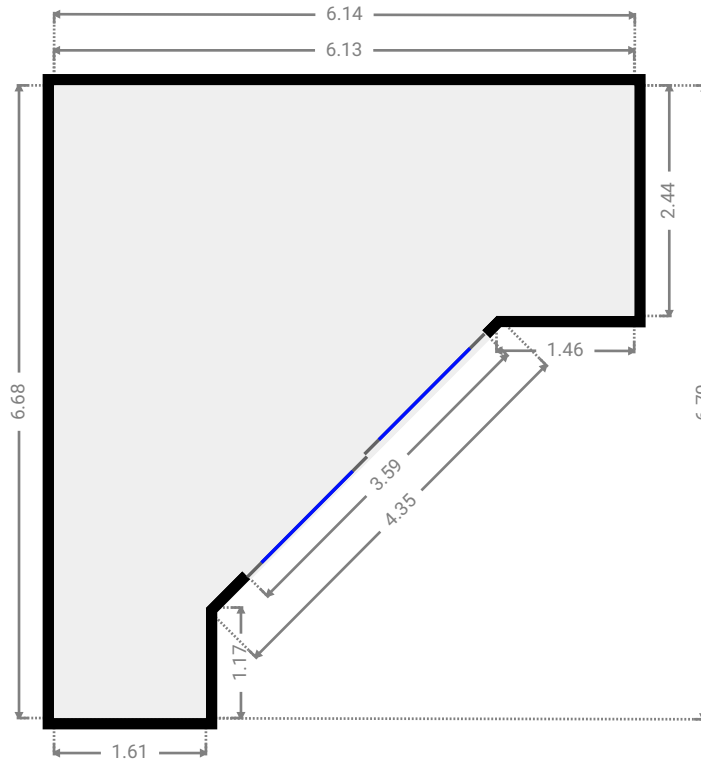
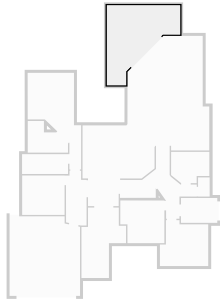

## ▼ Other Ground Floor

WIDTH: 3.73 m • LENGTH: 2.98 m  
AREA: 9.32 m<sup>2</sup> • PERIMETER: 13.42 m

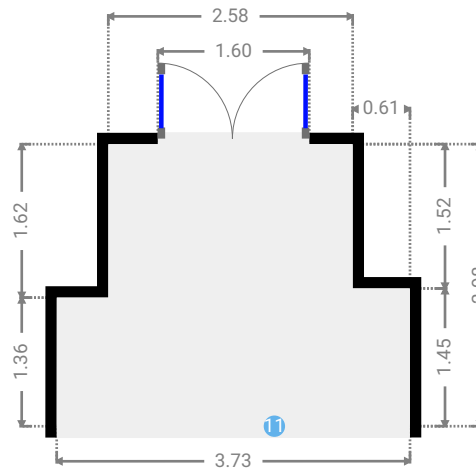
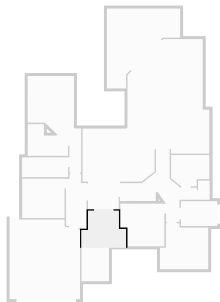

▼ Other/Ground Floor

11 OPENING

Height  
0.00 m



## ▼ Primary Bedroom Ground Floor

WIDTH: 4.48 m • LENGTH: 8.09 m  
AREA: 20.96 m<sup>2</sup> • PERIMETER: 23.95 m

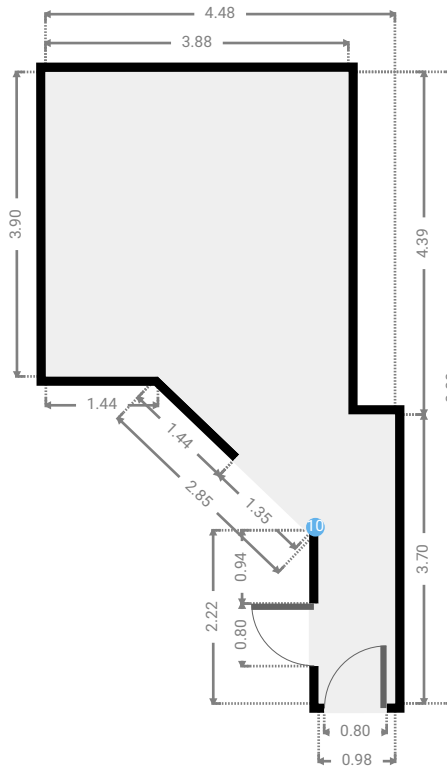
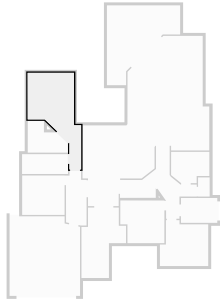

## ▼ Closet Ground Floor

WIDTH: 3.85 m • LENGTH: 1.66 m  
AREA: 6.39 m<sup>2</sup> • PERIMETER: 11.02 m

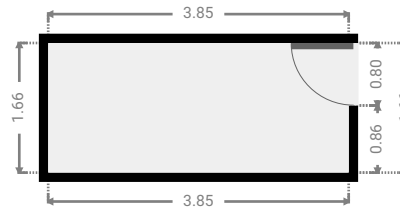
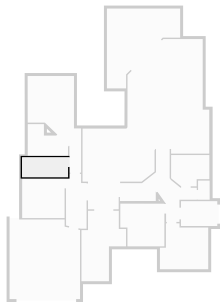

## ▼ Toilet Ground Floor

WIDTH: 0.97 m • LENGTH: 1.60 m  
AREA: 1.55 m<sup>2</sup> • PERIMETER: 5.14 m

