

12 Suthers Avenue

Ground Floor

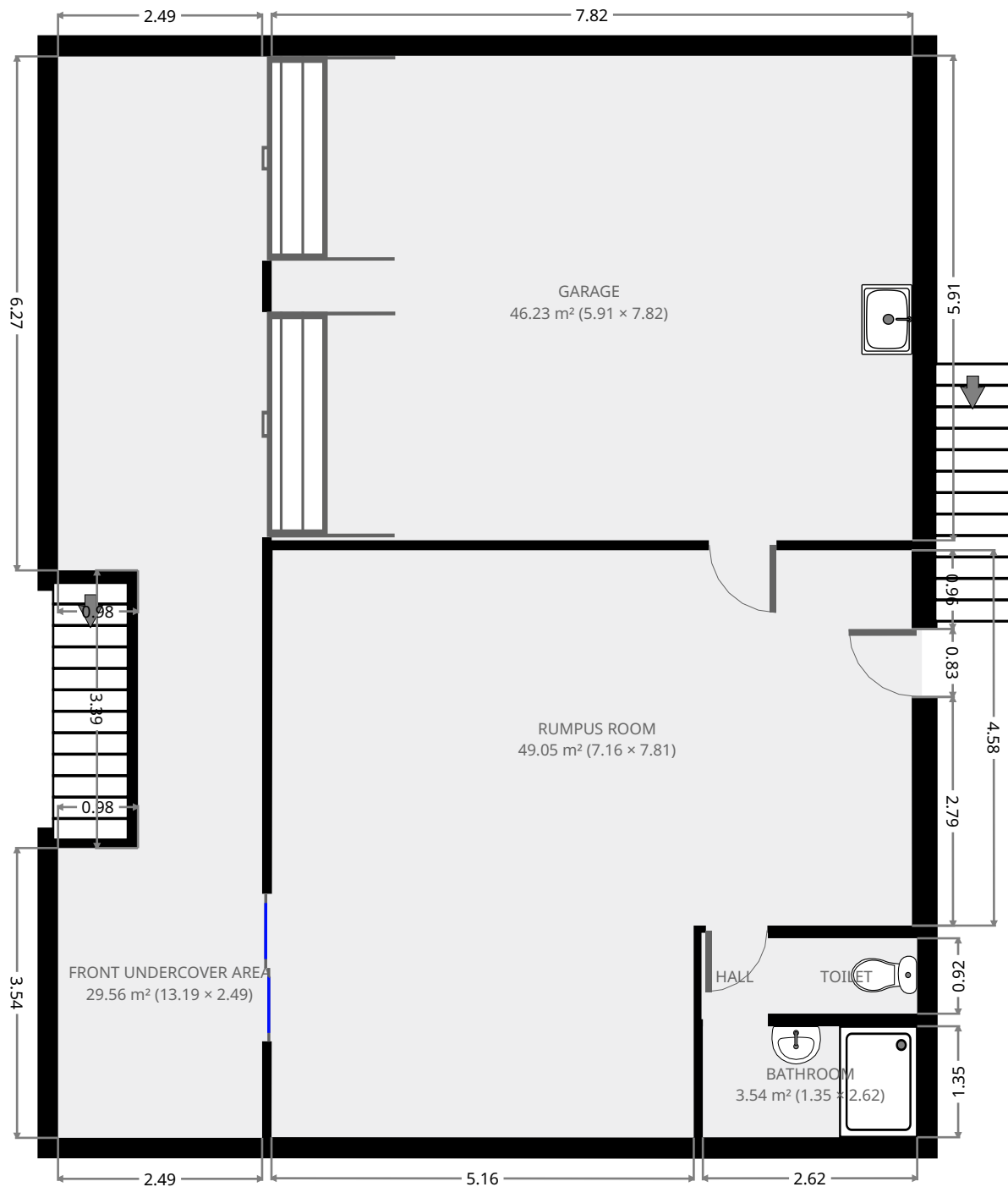

THIS FLOORPLAN IS PROVIDED WITHOUT WARRANTY OF ANY KIND. SENSOPIA DISCLAIMS ANY WARRANTY INCLUDING, WITHOUT LIMITATION, SATISFACTORY QUALITY OR ACCURACY OF DIMENSIONS.



12 Suthers Avenue

Garage

Width: 5.91 m
 Length: 7.82 m
 Area: 46.23 m²
 Perimeter: 27.46 m

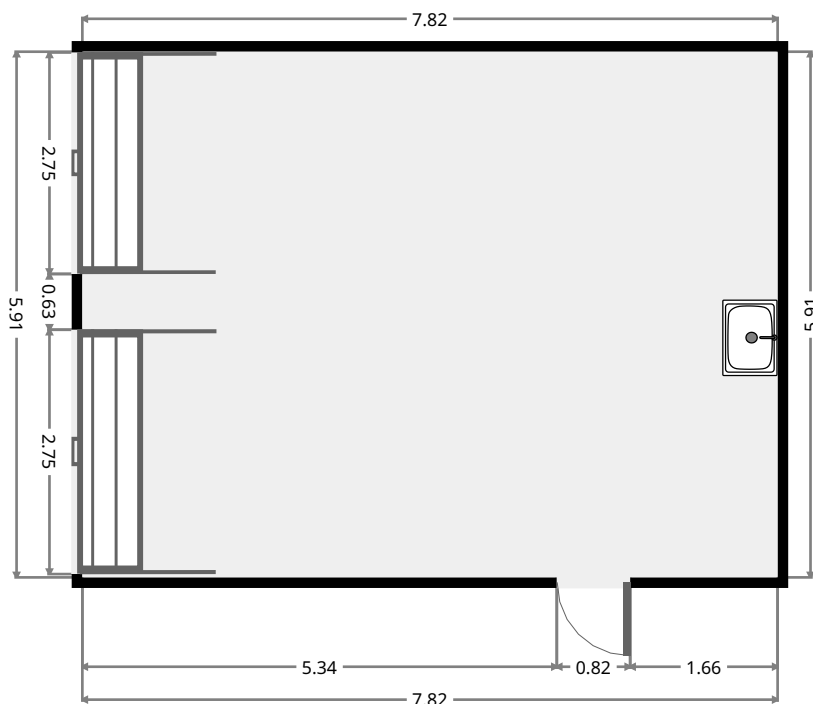
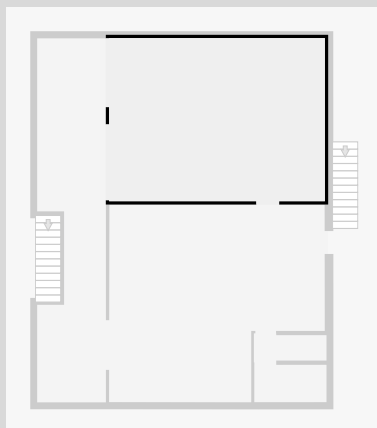

Rumpus Room

Width: 7.16 m
 Length: 7.81 m
 Area: 49.05 m²
 Perimeter: 29.94 m

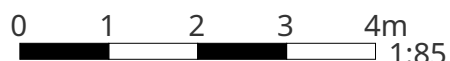
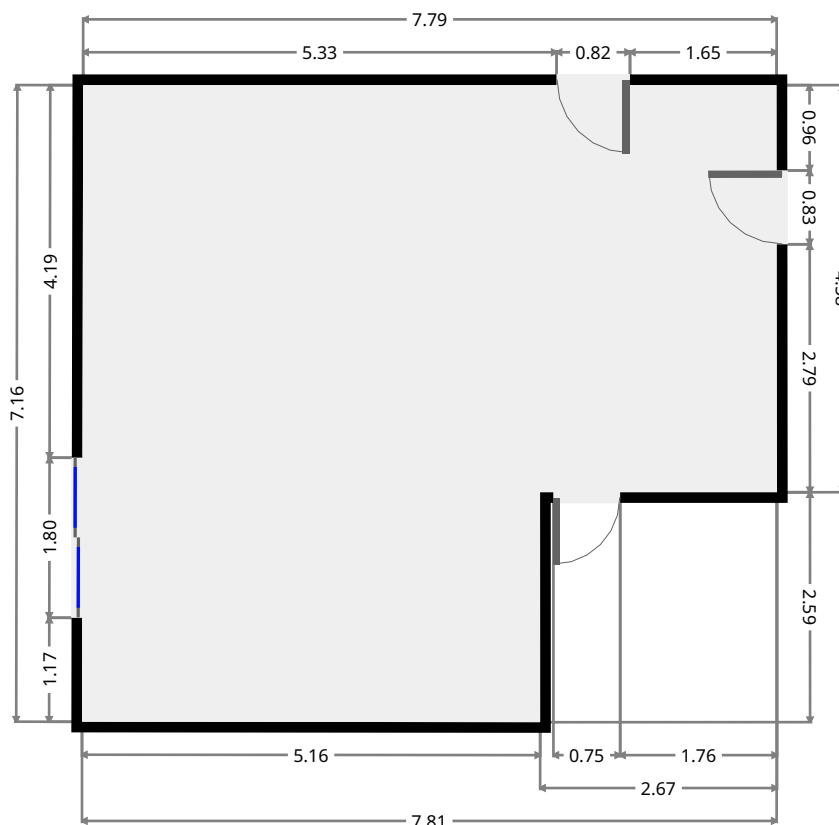
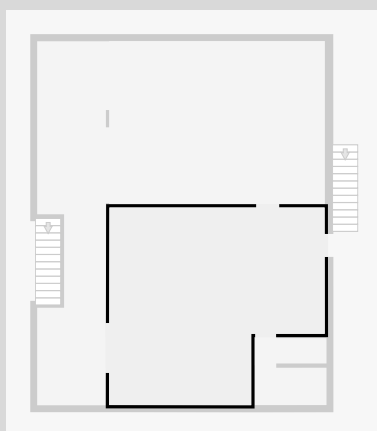

THIS FLOORPLAN IS PROVIDED WITHOUT WARRANTY OF ANY KIND. SENSOPIA DISCLAIMS ANY WARRANTY INCLUDING, WITHOUT LIMITATION, SATISFACTORY QUALITY OR ACCURACY OF DIMENSIONS.

12 Suthers Avenue

Hall

Width: 0.82 m
Length: 1.05 m
Area: 0.85 m²
Perimeter: 3.73 m

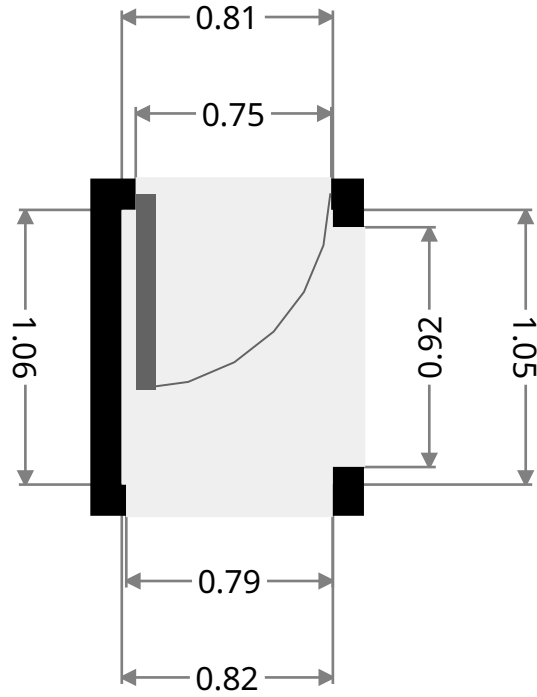
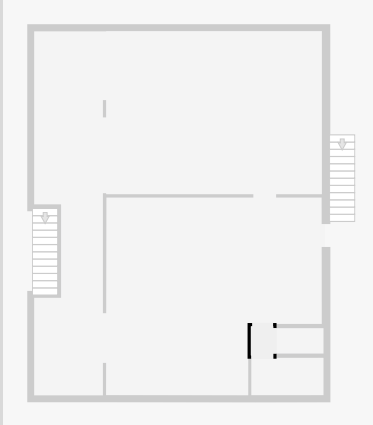

Toilet

Width: 0.92 m
Length: 1.73 m
Area: 1.58 m²
Perimeter: 5.28 m

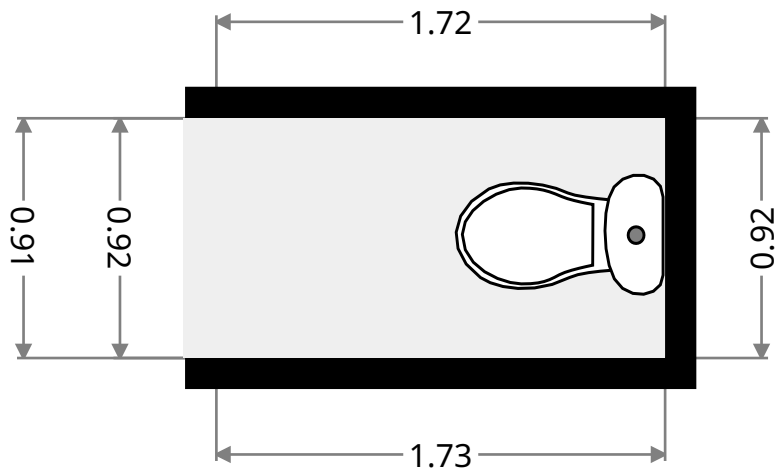
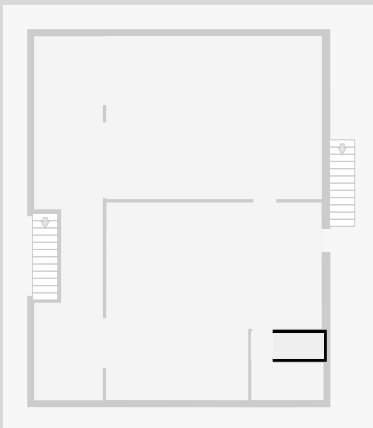

12 Suthers Avenue

Bathroom

Width: 1.35 m
Length: 2.62 m
Area: 3.54 m²
Perimeter: 7.94 m

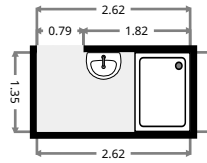
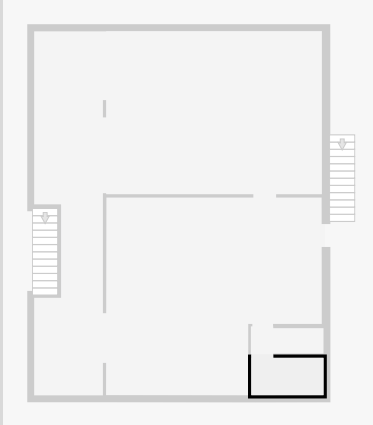

Front UnderCover Area

Width: 2.49 m
Length: 13.19 m
Area: 29.56 m²
Perimeter: 33.32 m

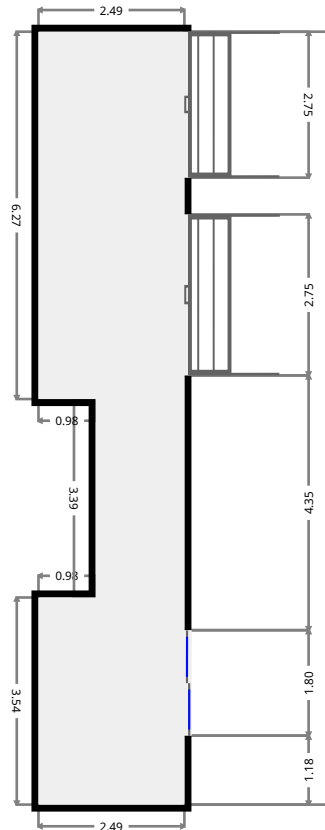
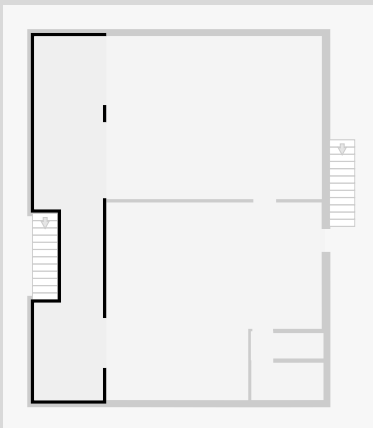

THIS FLOORPLAN IS PROVIDED WITHOUT WARRANTY OF ANY KIND. SENSOPIA DISCLAIMS ANY WARRANTY INCLUDING, WITHOUT LIMITATION, SATISFACTORY QUALITY OR ACCURACY OF DIMENSIONS.

12 Suthers Avenue

1st Floor

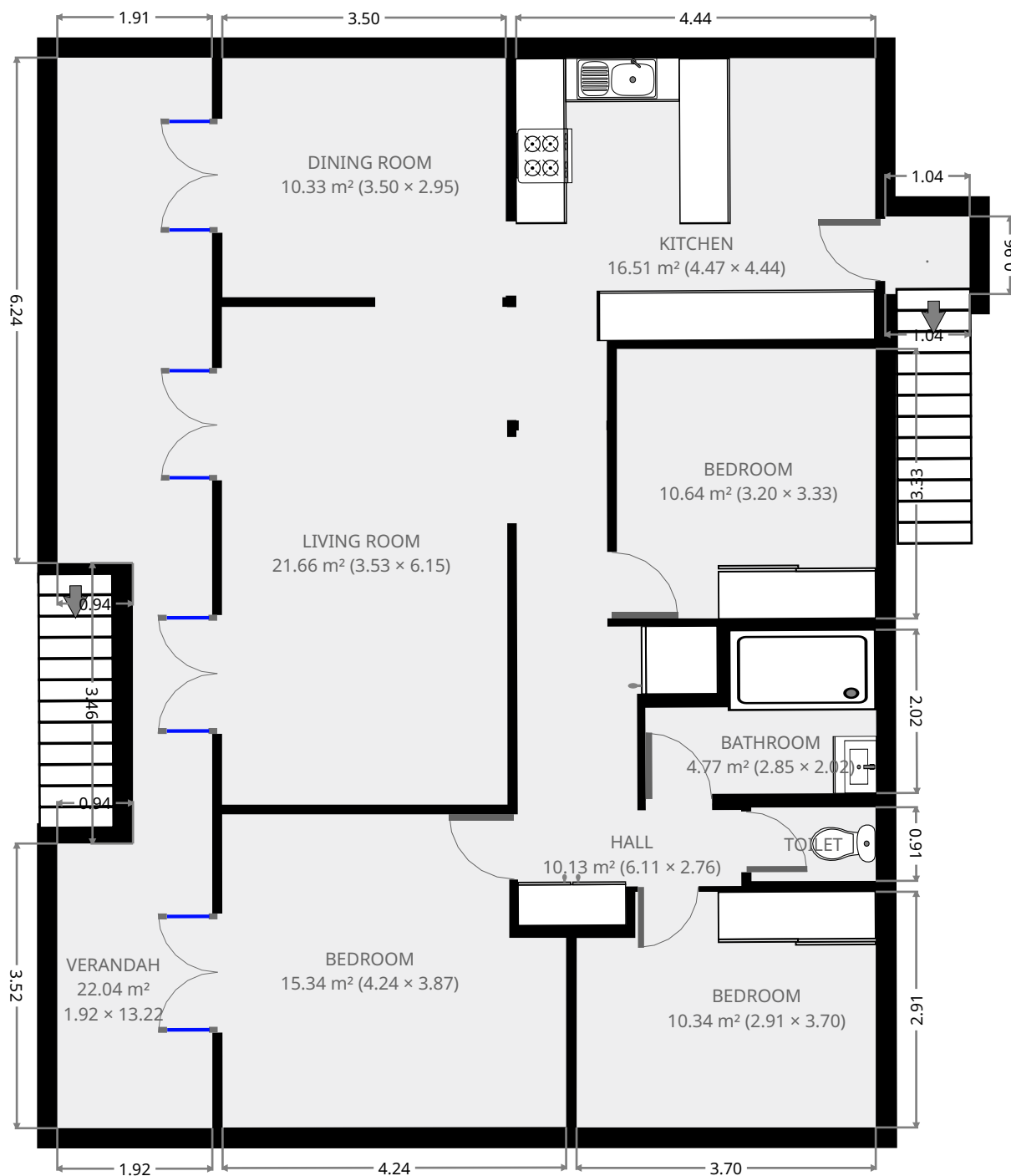

THIS FLOORPLAN IS PROVIDED WITHOUT WARRANTY OF ANY KIND. SENSOPIA DISCLAIMS ANY WARRANTY INCLUDING, WITHOUT LIMITATION, SATISFACTORY QUALITY OR ACCURACY OF DIMENSIONS.



12 Suthers Avenue

Living Room

Width: 3.53 m
 Length: 6.15 m
 Area: 21.66 m²
 Perimeter: 19.34 m

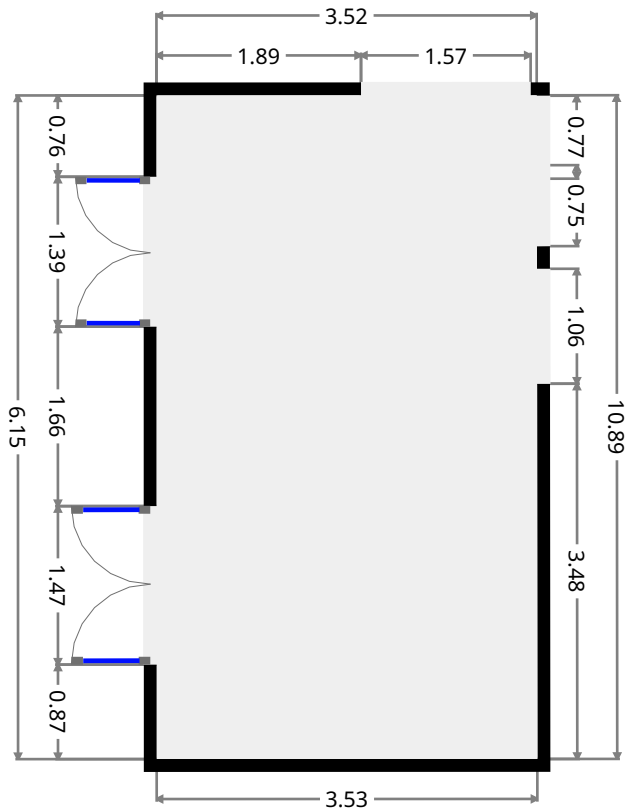
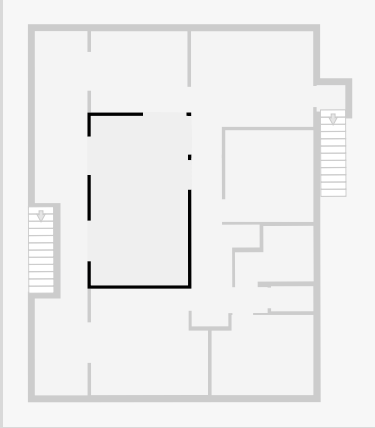

Dining Room

Width: 2.95 m
 Length: 3.50 m
 Area: 10.33 m²
 Perimeter: 12.91 m

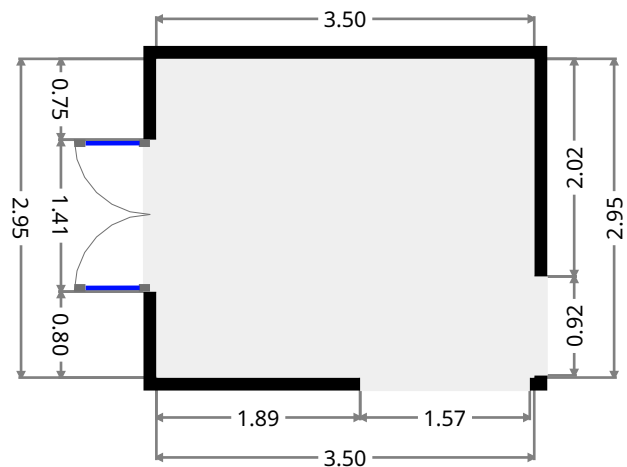
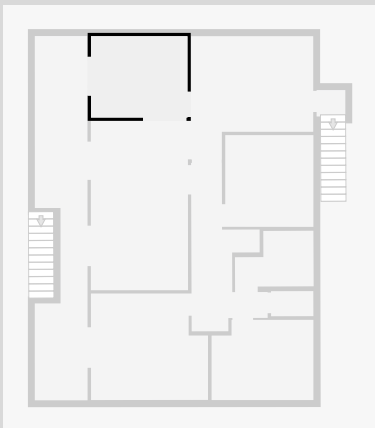

12 Suthers Avenue

Kitchen

Width: 4.44 m
 Length: 4.47 m
 Area: 16.51 m²
 Perimeter: 17.82 m

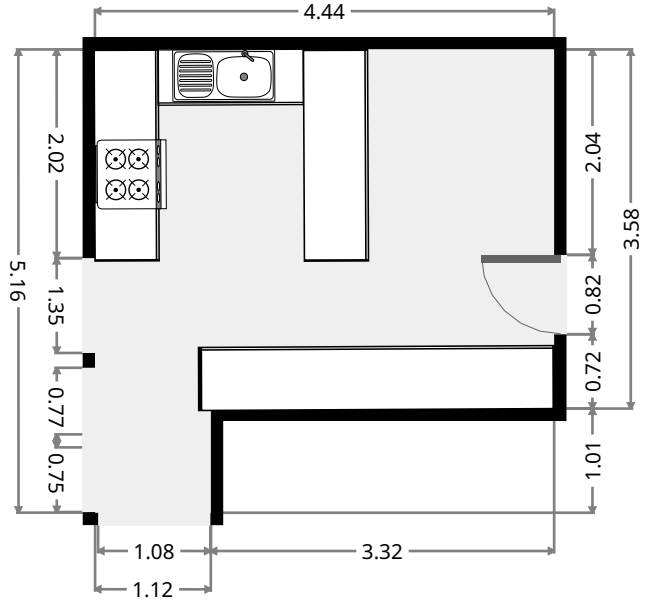
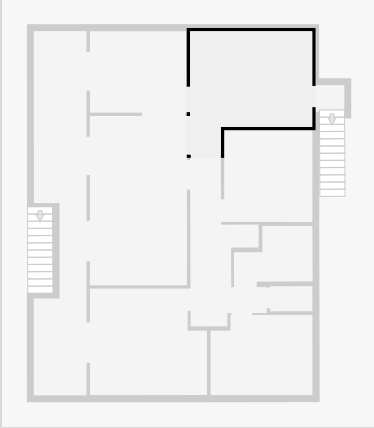

Hall

Width: 2.76 m
 Length: 6.11 m
 Area: 10.13 m²
 Perimeter: 19.75 m

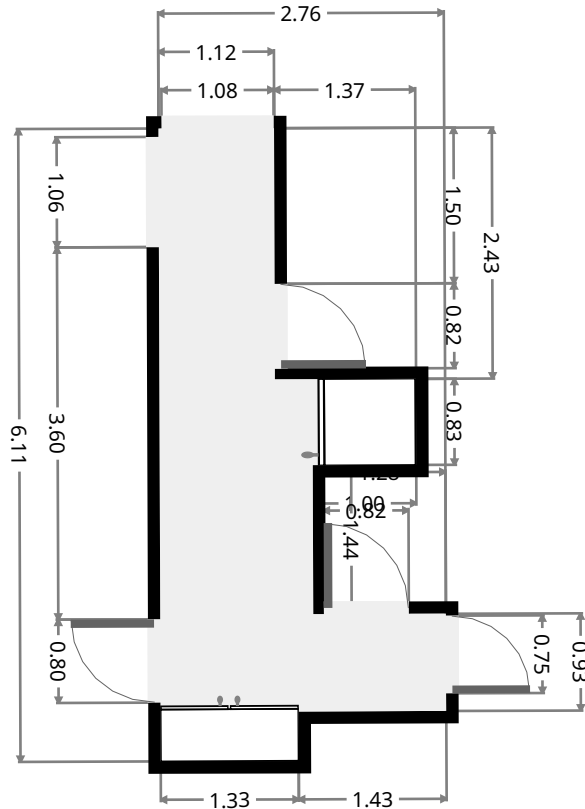
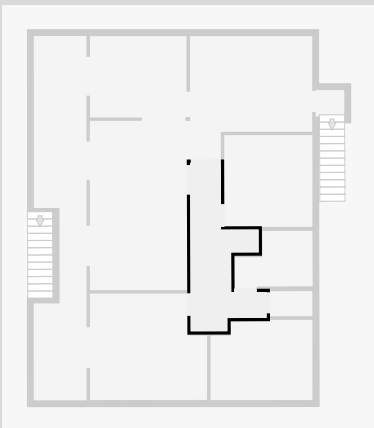

THIS FLOORPLAN IS PROVIDED WITHOUT WARRANTY OF ANY KIND. SENSOPIA DISCLAIMS ANY WARRANTY INCLUDING, WITHOUT LIMITATION, SATISFACTORY QUALITY OR ACCURACY OF DIMENSIONS.

12 Suthers Avenue

Bedroom

Width: 3.87 m
 Length: 4.24 m
 Area: 15.34 m²
 Perimeter: 16.22 m

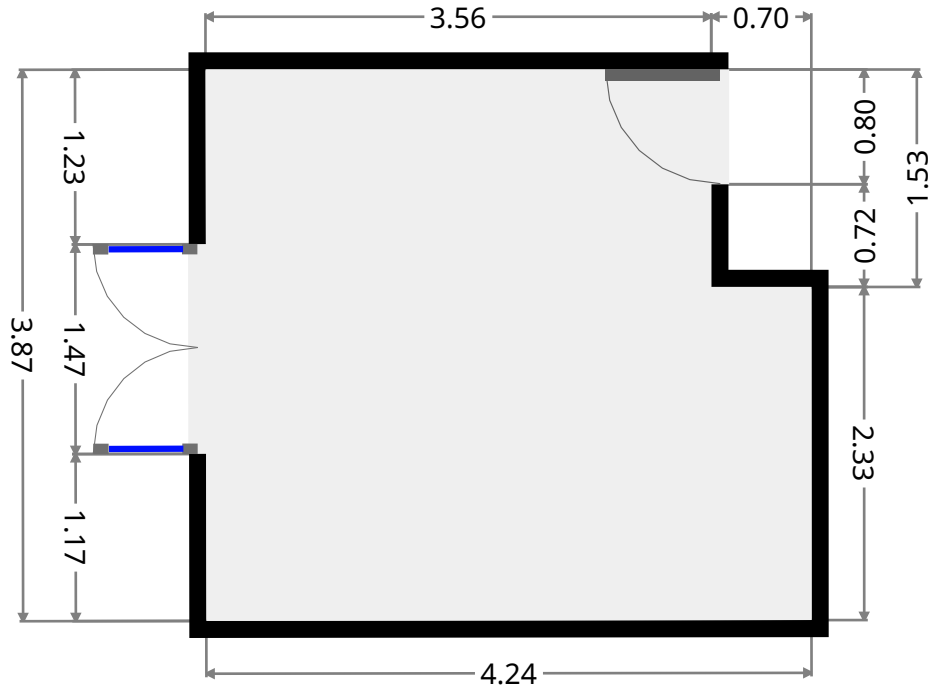
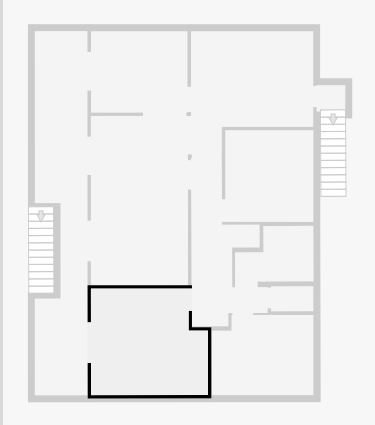

Toilet

Width: 0.90 m
 Length: 1.54 m
 Area: 1.40 m²
 Perimeter: 4.89 m

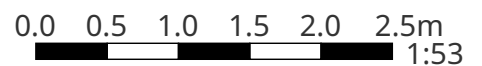
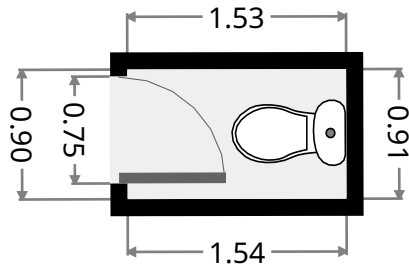
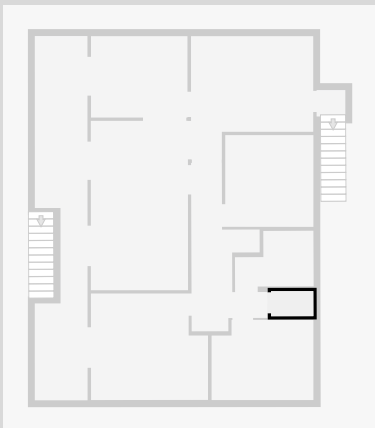

12 Suthers Avenue

Bedroom

Width: 2.91 m
Length: 3.70 m
Area: 10.34 m²
Perimeter: 13.21 m

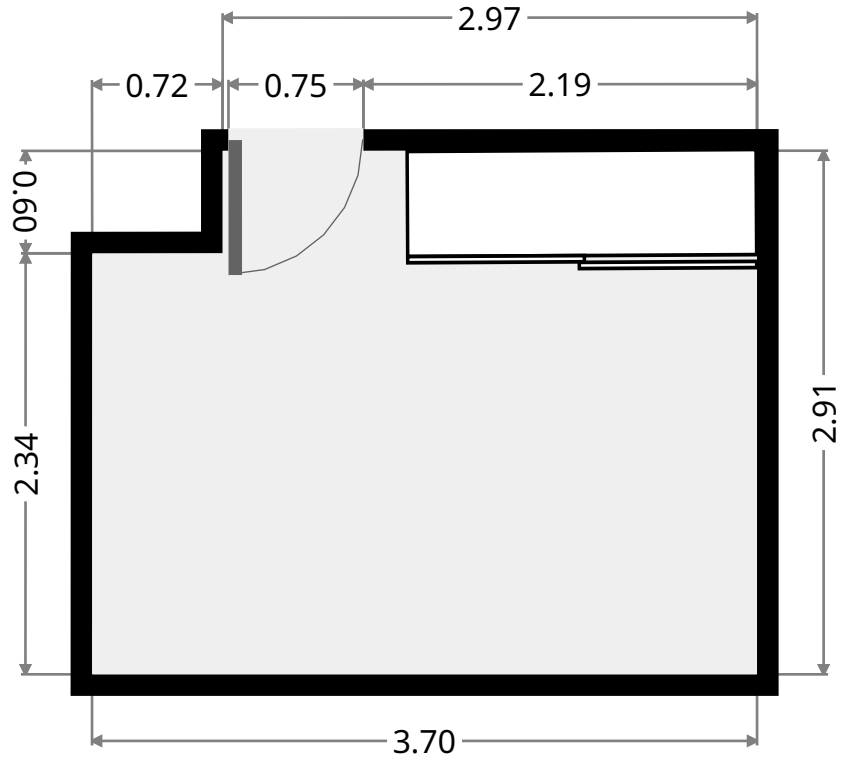
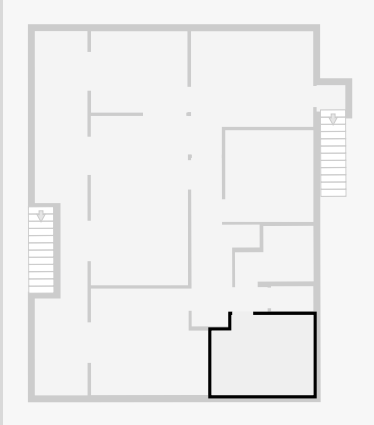

Bathroom

Width: 2.02 m
Length: 2.85 m
Area: 4.77 m²
Perimeter: 9.74 m

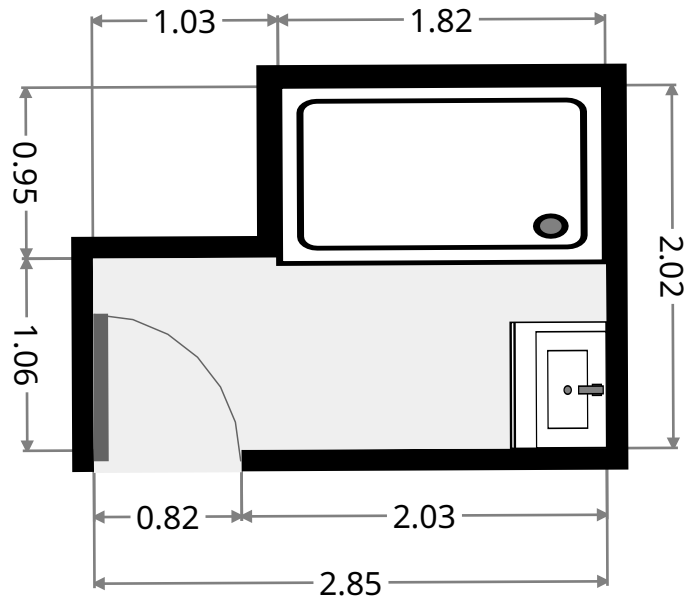
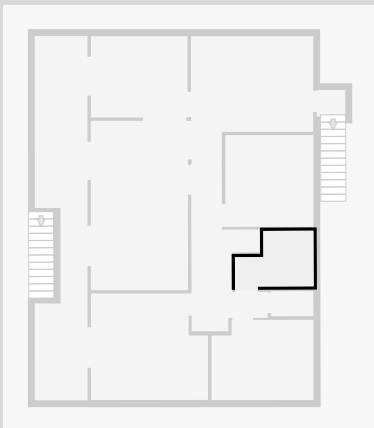

12 Suthers Avenue

Bedroom

Width: 3.20 m
Length: 3.33 m
Area: 10.64 m²
Perimeter: 13.05 m

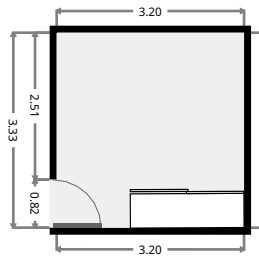
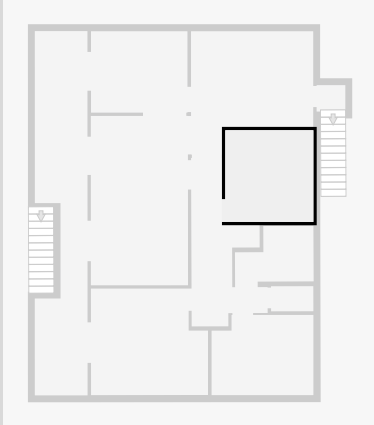

Verandah

Width: 1.92 m
Length: 13.22 m
Area: 22.04 m²
Perimeter: 32.13 m

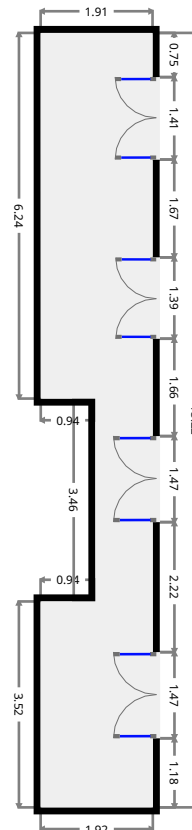
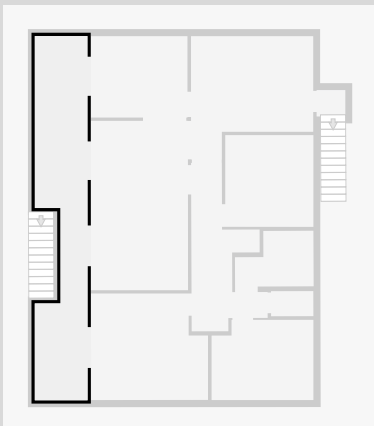

12 Suthers Avenue

•
Width: 0.96 m
Length: 1.04 m
Area: 1.00 m²
Perimeter: 4.00 m

