

12 Riley Drive

Ground Floor

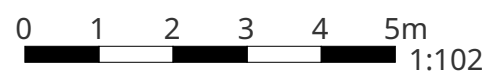

THIS FLOORPLAN IS PROVIDED WITHOUT WARRANTY OF ANY KIND. SENSOPIA DISCLAIMS ANY WARRANTY INCLUDING, WITHOUT LIMITATION, SATISFACTORY QUALITY OR ACCURACY OF DIMENSIONS.



12 Riley Drive

Bedroom

Width: 2.97 m
 Length: 3.58 m
 Area: 10.61 m²
 Perimeter: 13.09 m

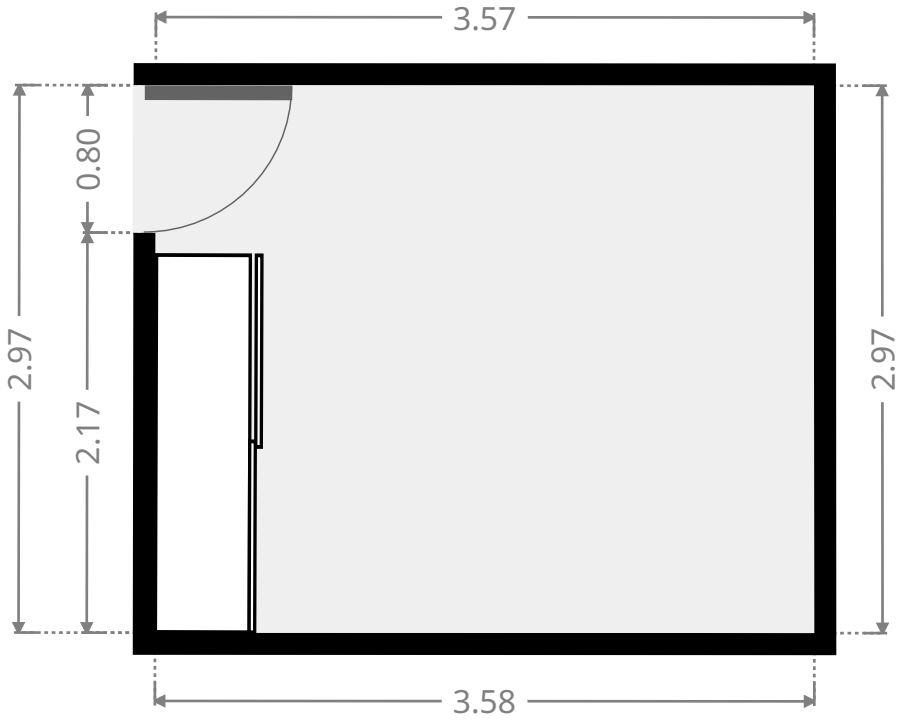
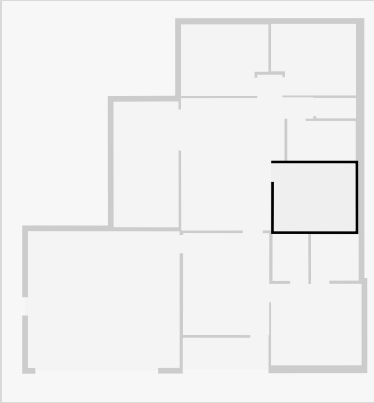

Bedroom

Width: 1.77 m
 Length: 3.00 m
 Area: 5.31 m²
 Perimeter: 9.54 m

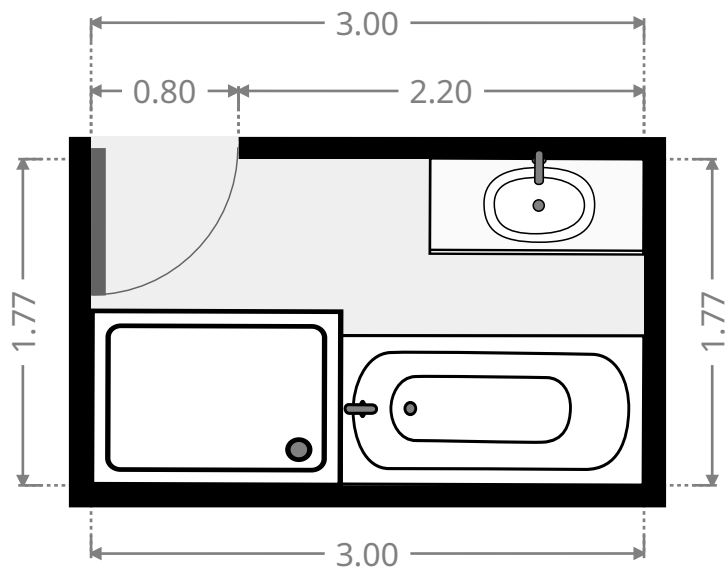
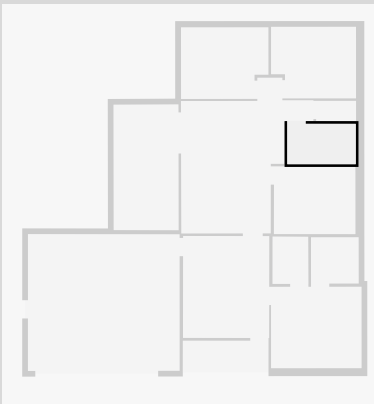

12 Riley Drive

Toilet / Half Bath

Width: 0.90 m
Length: 1.75 m
Area 1.57 m²
Perimeter 5.29 m

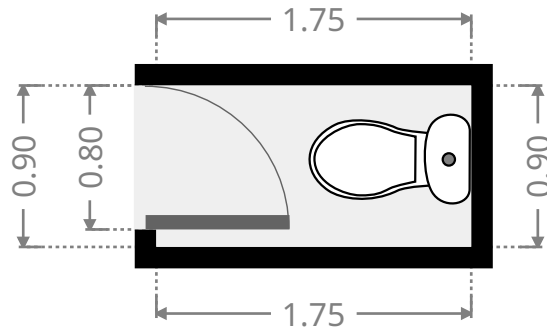
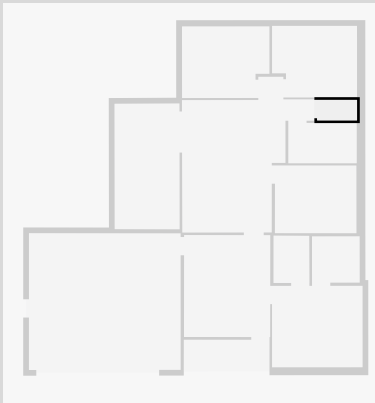

Bedroom

Width: 3.14 m
Length: 3.73 m
Area 11.05 m²
Perimeter 13.73 m

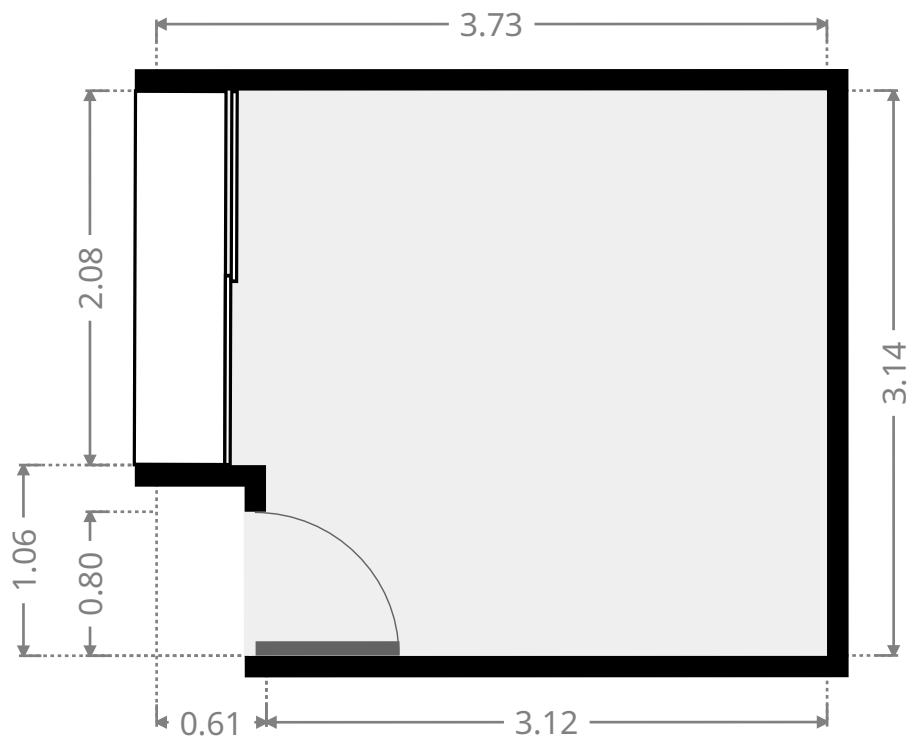
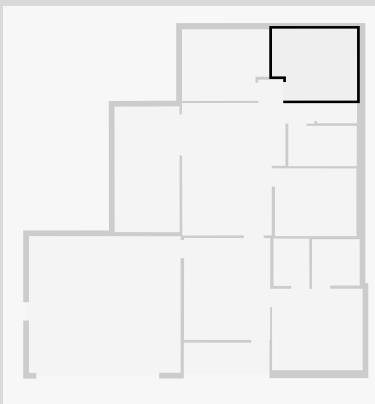

12 Riley Drive

Bedroom

Width: 3.14 m
 Length: 3.83 m
 Area: 11.39 m²
 Perimeter: 13.95 m

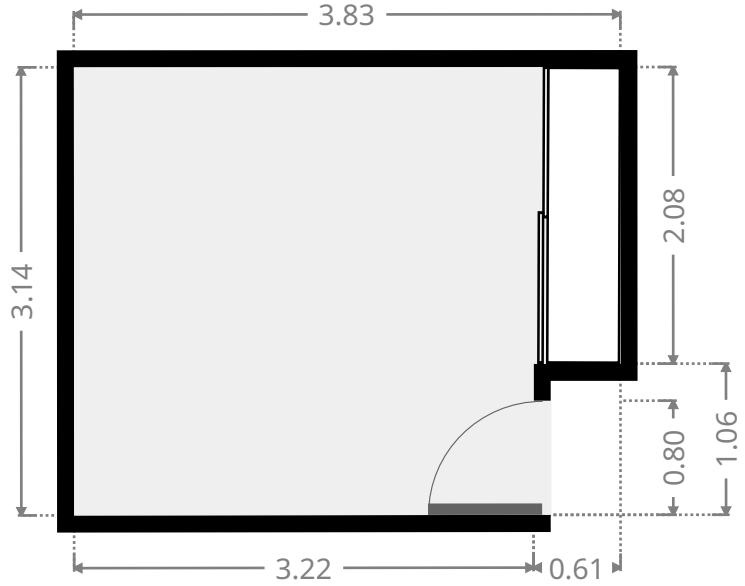
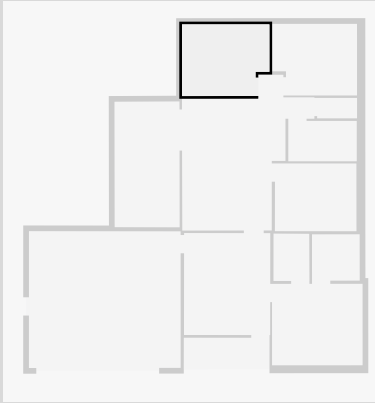

Master Bedroom

Width: 3.57 m
 Length: 3.97 m
 Area: 14.18 m²
 Perimeter: 15.08 m

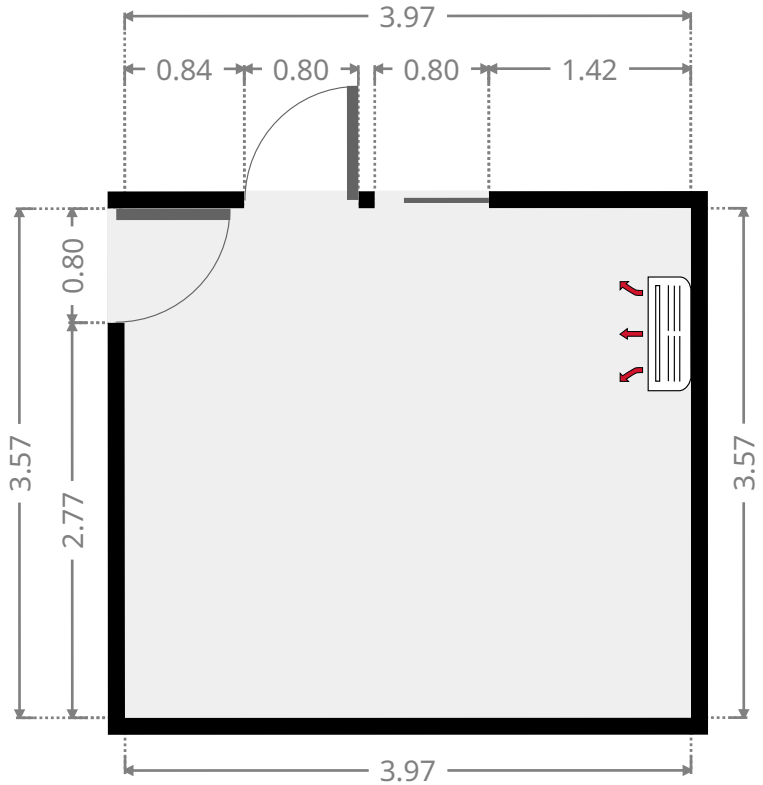
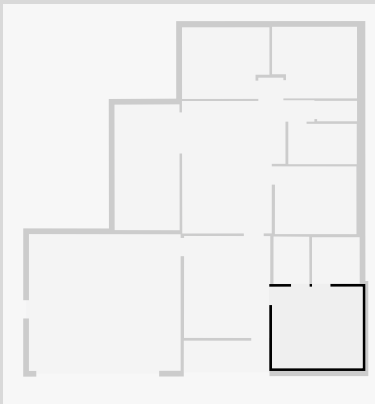

THIS FLOORPLAN IS PROVIDED WITHOUT WARRANTY OF ANY KIND. SENSOPIA DISCLAIMS ANY WARRANTY INCLUDING, WITHOUT LIMITATION, SATISFACTORY QUALITY OR ACCURACY OF DIMENSIONS.

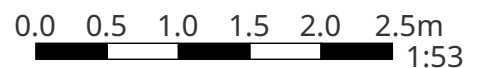

12 Riley Drive

Bathroom

Width: 2.03 m
 Length: 2.09 m
 Area: 4.24 m²
 Perimeter: 8.24 m

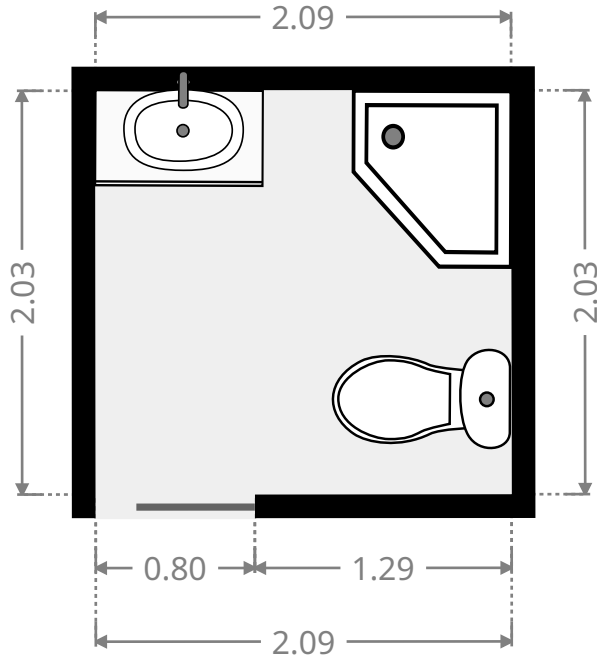
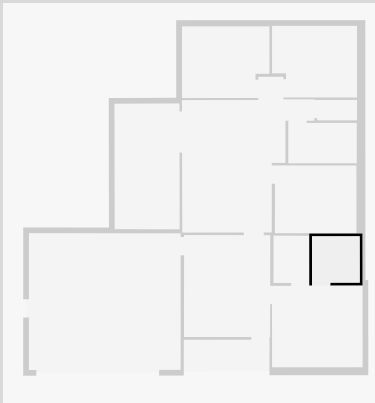

Closet

Width: 1.59 m
 Length: 2.08 m
 Area: 3.26 m²
 Perimeter: 7.29 m

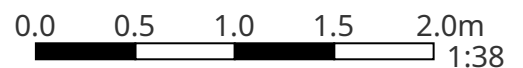
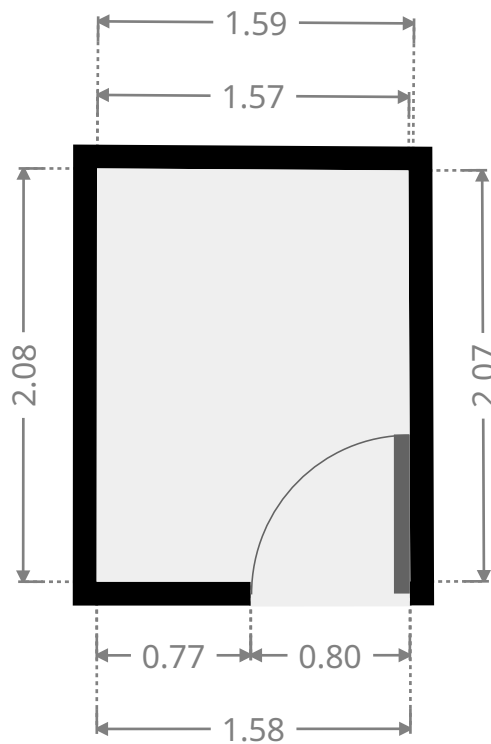
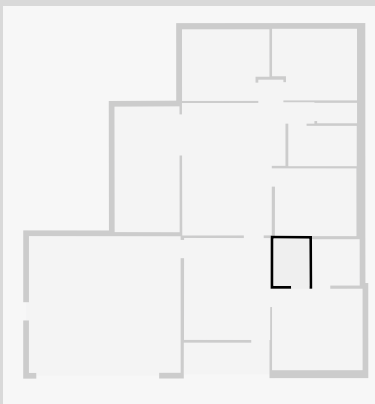

THIS FLOORPLAN IS PROVIDED WITHOUT WARRANTY OF ANY KIND. SENSOPIA DISCLAIMS ANY WARRANTY INCLUDING, WITHOUT LIMITATION, SATISFACTORY QUALITY OR ACCURACY OF DIMENSIONS.

12 Riley Drive

Garage

Width: 6.00 m
 Length: 6.66 m
 Area: 39.86 m²
 Perimeter: 25.29 m

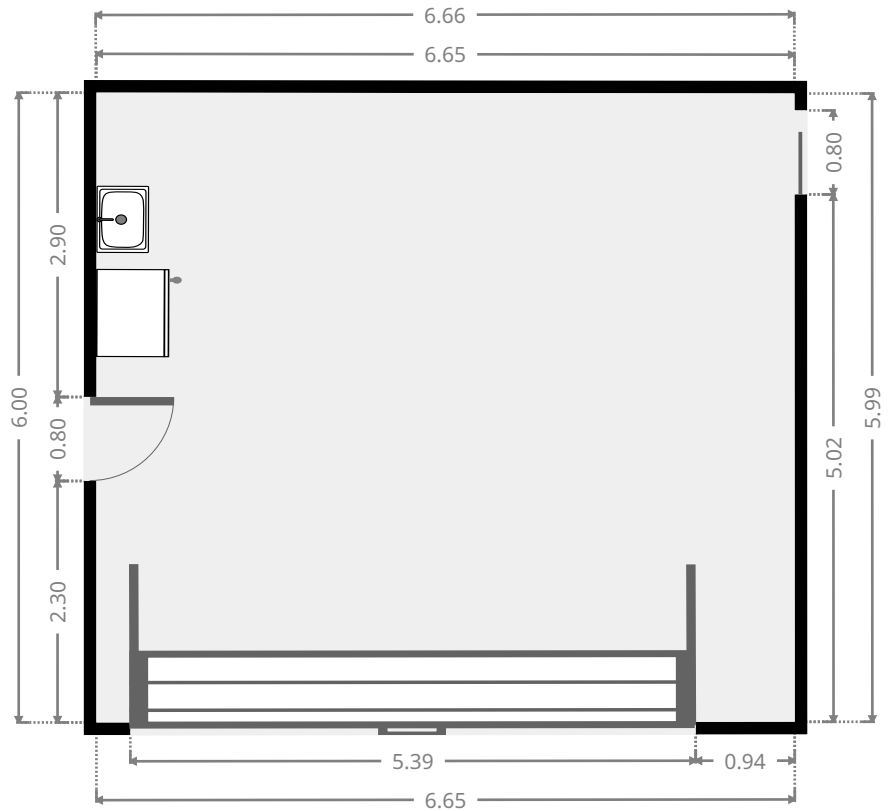
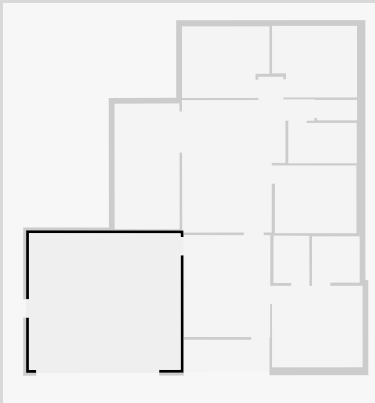

Entertainment Area

Width: 2.87 m
 Length: 5.52 m
 Area: 15.70 m²
 Perimeter: 16.72 m

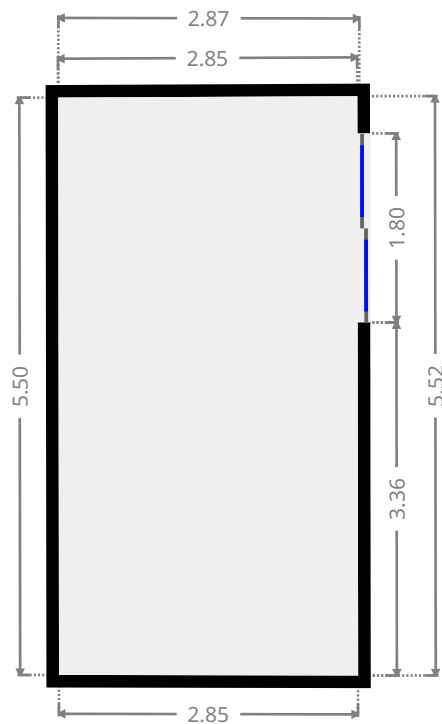
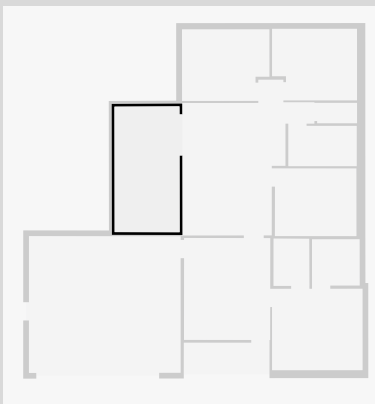

THIS FLOORPLAN IS PROVIDED WITHOUT WARRANTY OF ANY KIND. SENSOPIA DISCLAIMS ANY WARRANTY INCLUDING, WITHOUT LIMITATION, SATISFACTORY QUALITY OR ACCURACY OF DIMENSIONS.



12 Riley Drive

Other

Width: 1.27 m
Length: 3.76 m
Area: 4.76 m²
Perimeter: 10.05 m

