

12 Nagle Drive

Created on
2021-03-30

Floors
1

▼ Ground Floor



▼ Bathroom Ground Floor

WIDTH: 2.00 m • LENGTH: 2.44 m
AREA: 4.88 m² • PERIMETER: 8.88 m

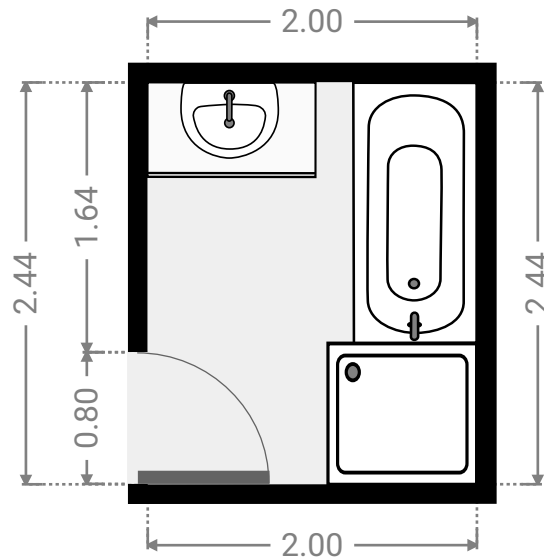
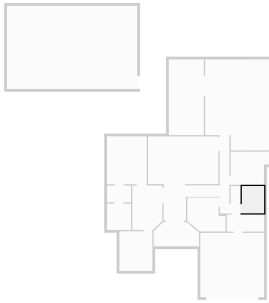

▼ Living Room Ground Floor

WIDTH: 4.09 m • LENGTH: 2.19 m
AREA: 8.07 m² • PERIMETER: 11.47 m

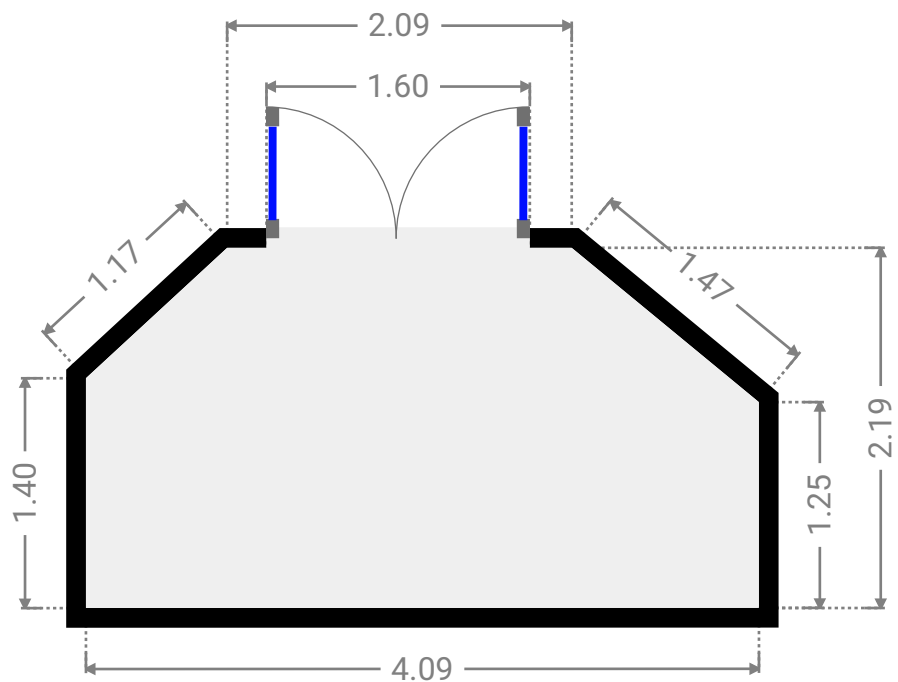
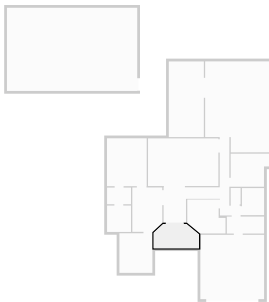

▼ Other
Ground Floor

WIDTH: 11.75 m • LENGTH: 7.50 m
AREA: 88.12 m² • PERIMETER: 38.50 m

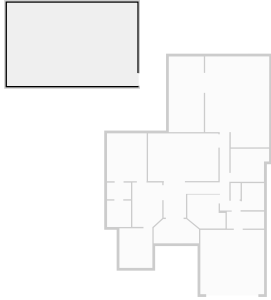

▼ Other
Ground Floor

WIDTH: 3.16 m • LENGTH: 6.82 m
AREA: 21.55 m² • PERIMETER: 19.96 m

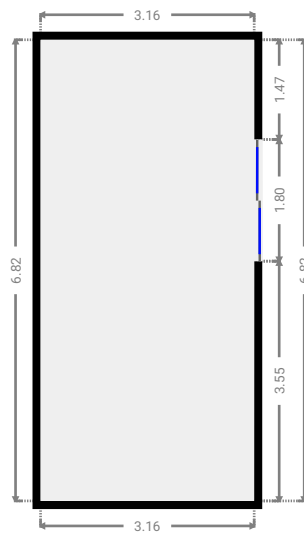
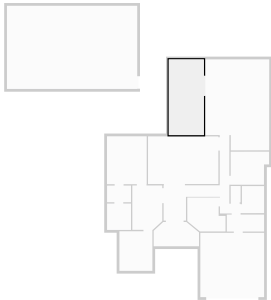

▼ **Kitchen**
Ground Floor

WIDTH: 5.79 m • LENGTH: 8.21 m
AREA: 44.20 m² • PERIMETER: 27.96 m

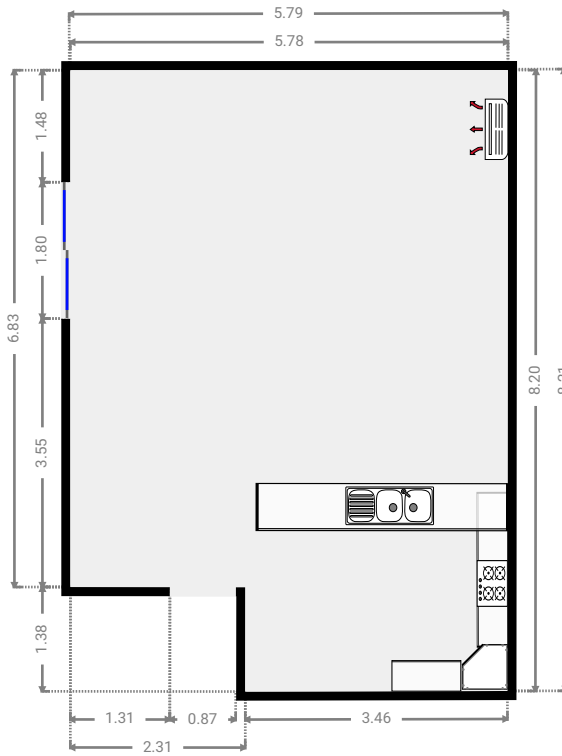
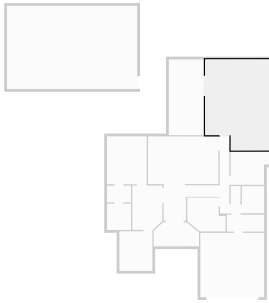

▼ **Bedroom**
Ground Floor

WIDTH: 3.46 m • LENGTH: 2.98 m
AREA: 9.48 m² • PERIMETER: 12.89 m

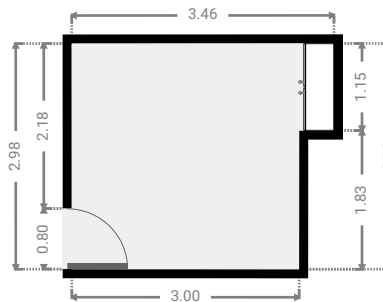
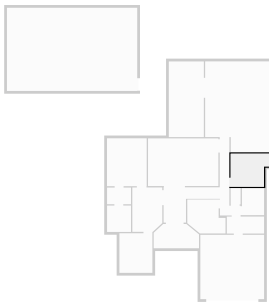

▼ **Garage**
Ground Floor

WIDTH: 5.75 m • LENGTH: 5.80 m
AREA: 33.35 m² • PERIMETER: 23.10 m

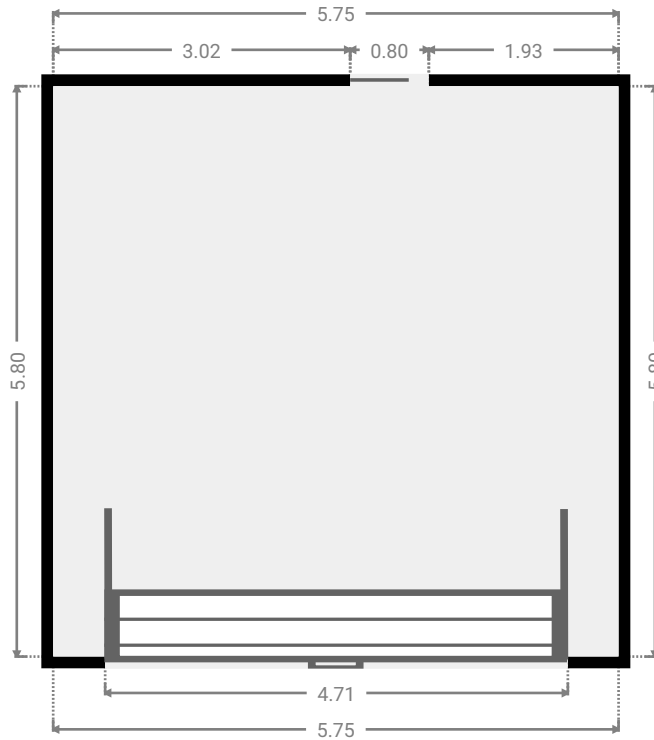
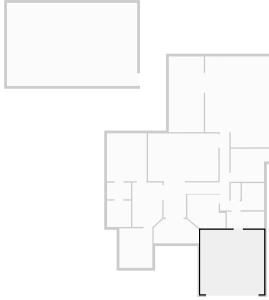

▼ **Laundry Room**
Ground Floor

WIDTH: 3.36 m • LENGTH: 1.53 m
AREA: 5.14 m² • PERIMETER: 9.78 m

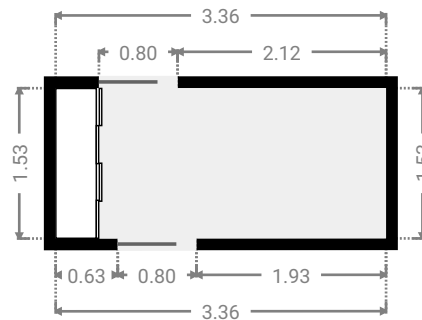
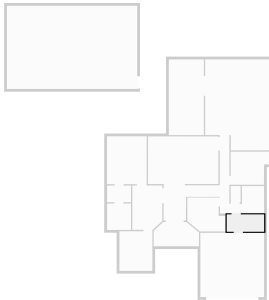

▼ Toilet
Ground Floor

WIDTH: 0.90 m • LENGTH: 1.48 m
AREA: 1.32 m² • PERIMETER: 4.74 m

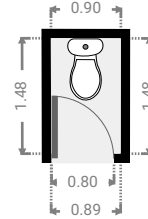
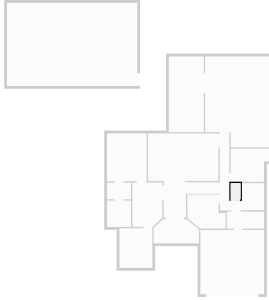

▼ Hall
Ground Floor

WIDTH: 6.94 m • LENGTH: 7.59 m
AREA: 16.48 m² • PERIMETER: 32.07 m

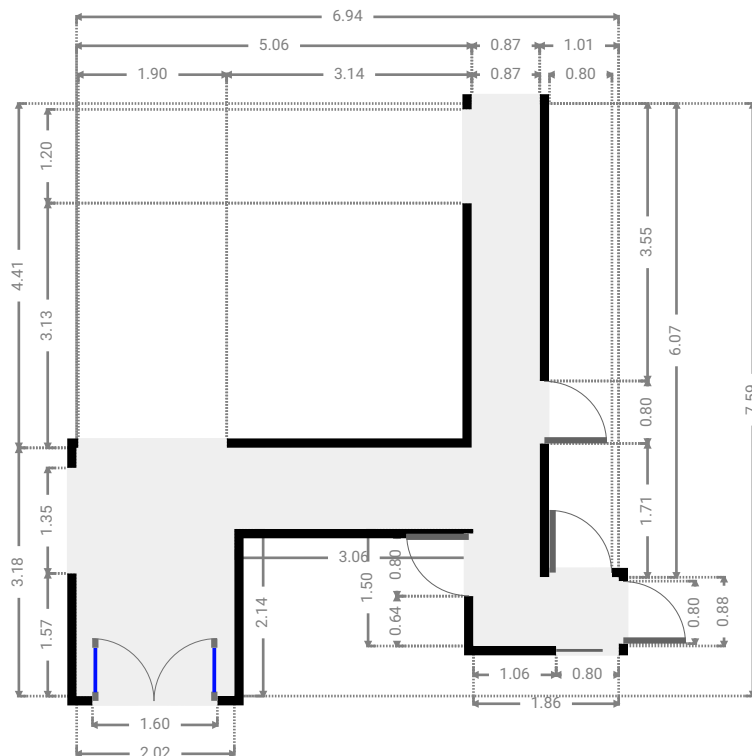
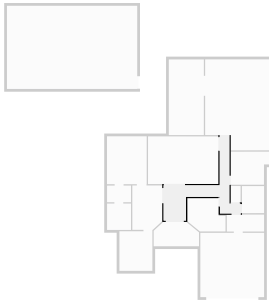

▼ Bedroom Ground Floor

WIDTH: 3.45 m • LENGTH: 3.06 m
AREA: 8.98 m² • PERIMETER: 12.41 m

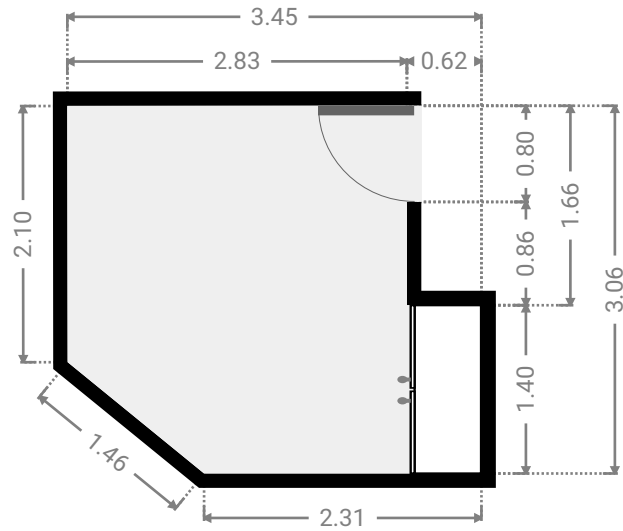
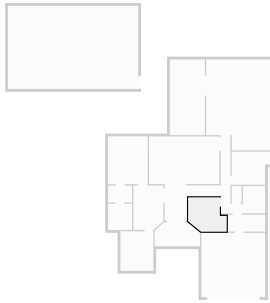

▼ Living Room Ground Floor

WIDTH: 6.35 m • LENGTH: 4.30 m
AREA: 27.29 m² • PERIMETER: 21.29 m

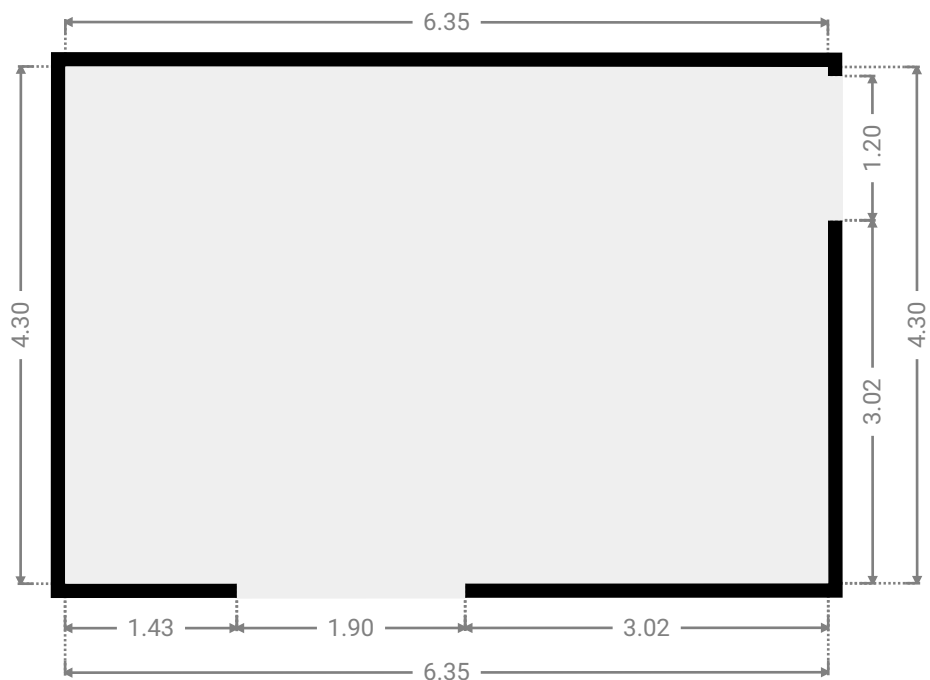
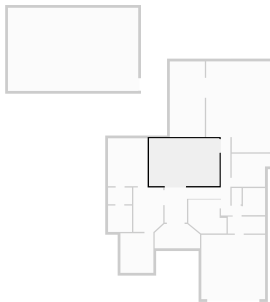

▼ **Bathroom**
Ground Floor

WIDTH: 2.16 m • LENGTH: 2.38 m
AREA: 5.14 m² • PERIMETER: 9.08 m

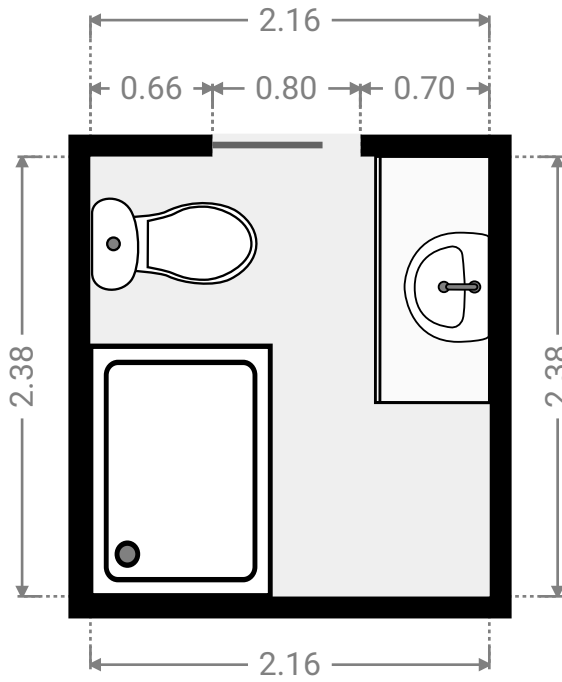
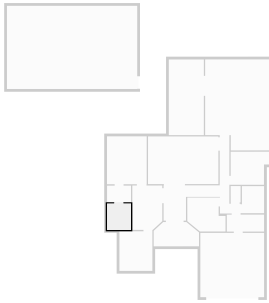

▼ **Closet**
Ground Floor

WIDTH: 2.16 m • LENGTH: 1.50 m
AREA: 3.24 m² • PERIMETER: 7.32 m

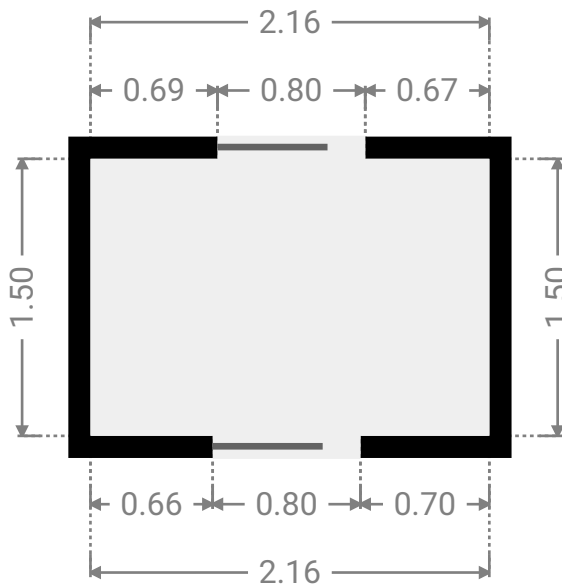
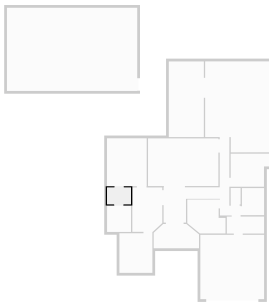

▼ Master Bedroom Ground Floor

WIDTH: 3.58 m • LENGTH: 4.32 m
AREA: 15.47 m² • PERIMETER: 15.80 m

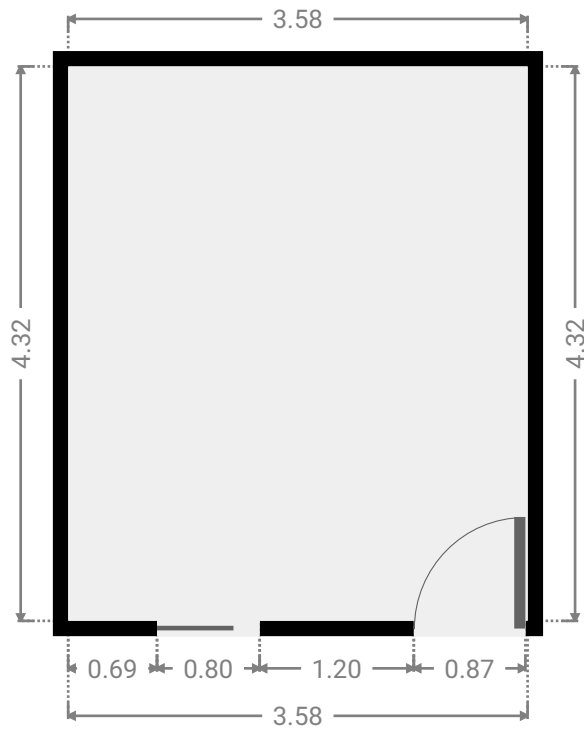
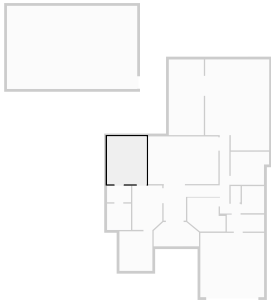

▼ Bedroom Ground Floor

WIDTH: 2.97 m • LENGTH: 3.57 m
AREA: 10.60 m² • PERIMETER: 13.08 m

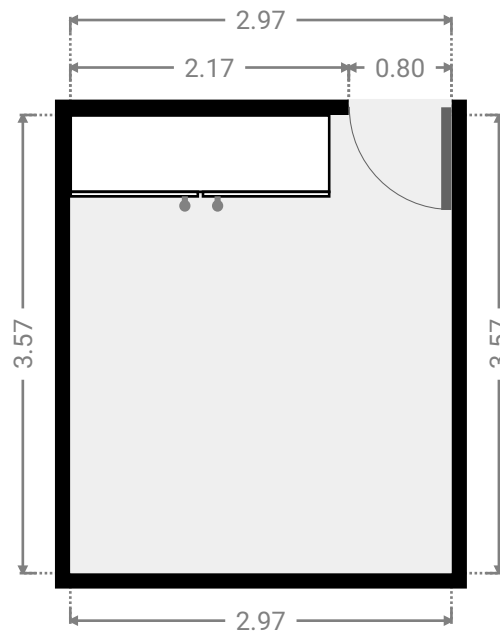
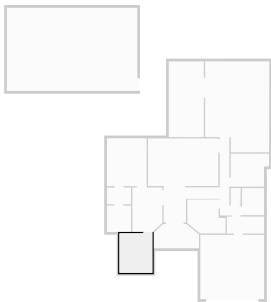

▼ Living Room Ground Floor

WIDTH: 2.70 m • LENGTH: 4.00 m
AREA: 10.46 m² • PERIMETER: 12.92 m

