

12 Maple Street

Created on
2020-09-24

Floors
1

▼ Ground Floor



THIS FLOORPLAN IS PROVIDED WITHOUT WARRANTY OF ANY KIND. SENSOPIA DISCLAIMS ANY WARRANTY INCLUDING, WITHOUT LIMITATION, SATISFACTORY QUALITY OR ACCURACY OF DIMENSIONS.

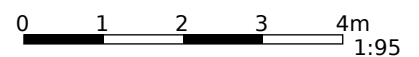

▼ Living Room Ground Floor

WIDTH: 10.95 m • LENGTH: 11.29 m
AREA: 59.00 m² • PERIMETER: 44.48 m

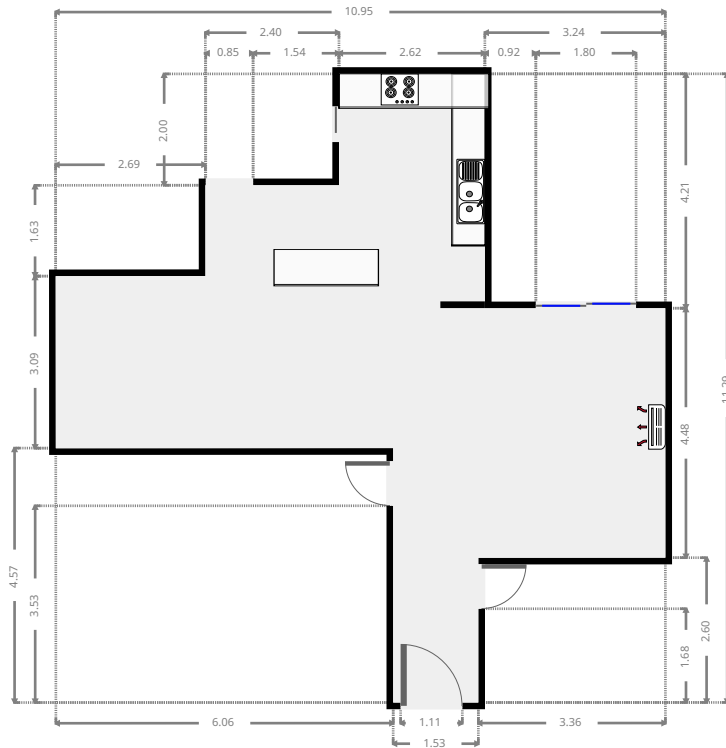
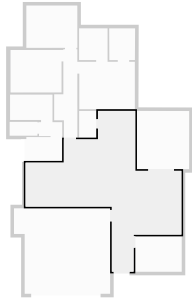

▼ Laundry Room Ground Floor

WIDTH: 2.50 m • LENGTH: 1.77 m
AREA: 4.42 m² • PERIMETER: 8.54 m

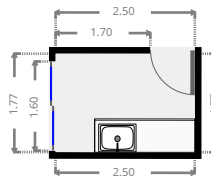
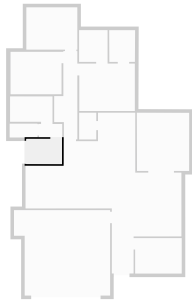

▼ Hall Ground Floor

WIDTH: 1.63 m • LENGTH: 0.98 m
AREA: 1.60 m² • PERIMETER: 5.22 m

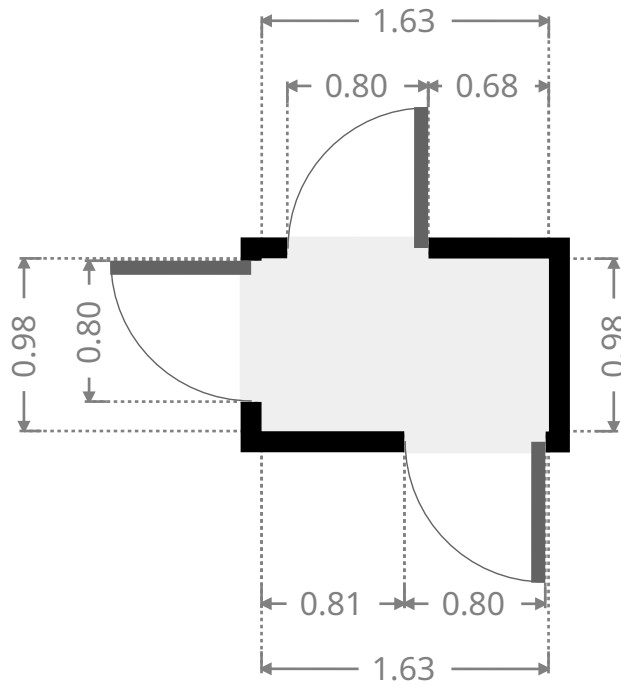
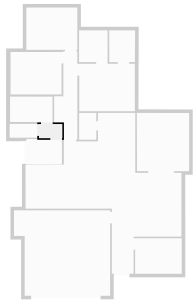

▼ Toilet Ground Floor

WIDTH: 1.95 m • LENGTH: 0.97 m
AREA: 1.89 m² • PERIMETER: 5.84 m

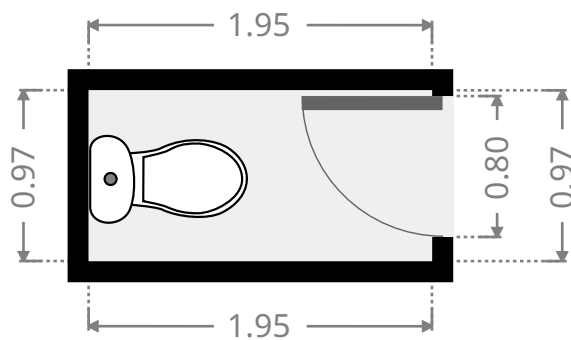
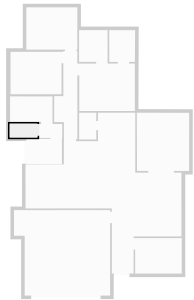

▼ Bathroom Ground Floor

WIDTH: 2.98 m • LENGTH: 1.78 m
AREA: 5.31 m² • PERIMETER: 9.52 m

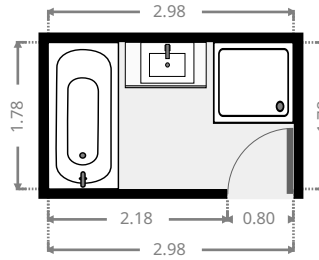
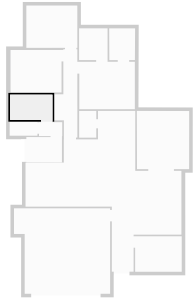

▼ Hall Ground Floor

WIDTH: 1.63 m • LENGTH: 6.20 m
AREA: 7.22 m² • PERIMETER: 15.65 m

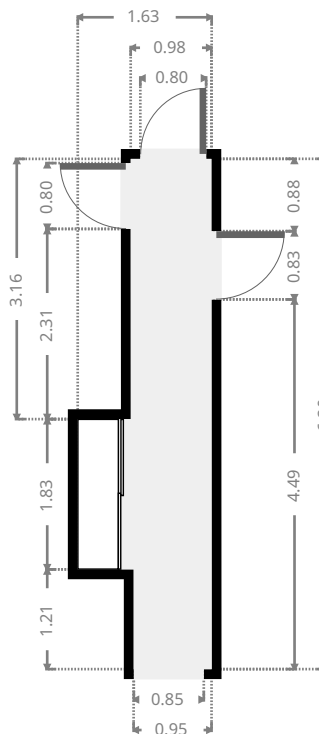
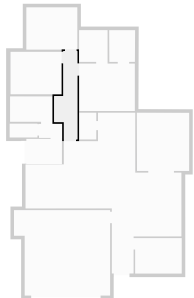

FLOORS: 1

▼ **Bedroom**
Ground Floor

WIDTH: 3.58 m • LENGTH: 2.98 m
AREA: 10.67 m² • PERIMETER: 13.12 m

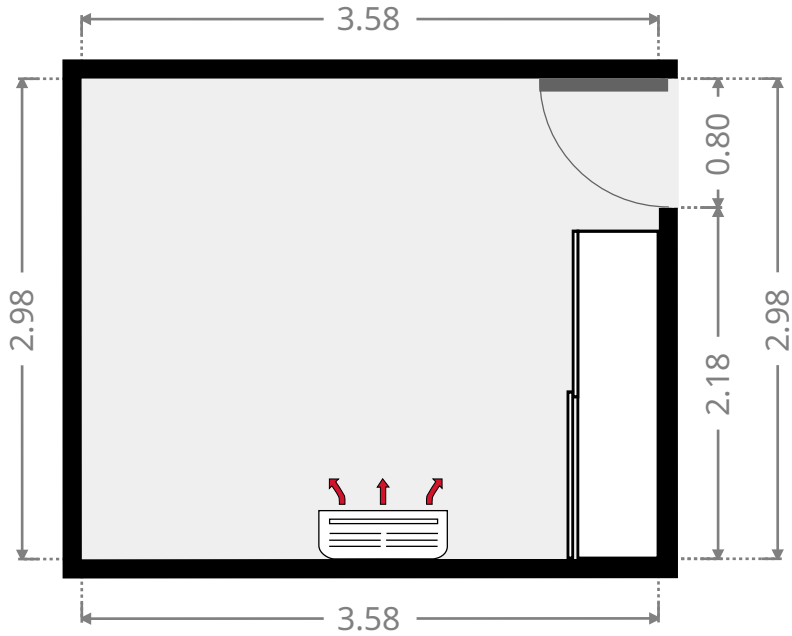
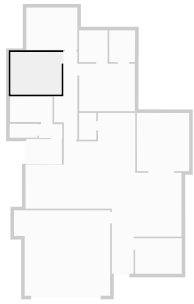

▼ **Bedroom**
Ground Floor

WIDTH: 3.58 m • LENGTH: 2.97 m
AREA: 10.63 m² • PERIMETER: 13.10 m

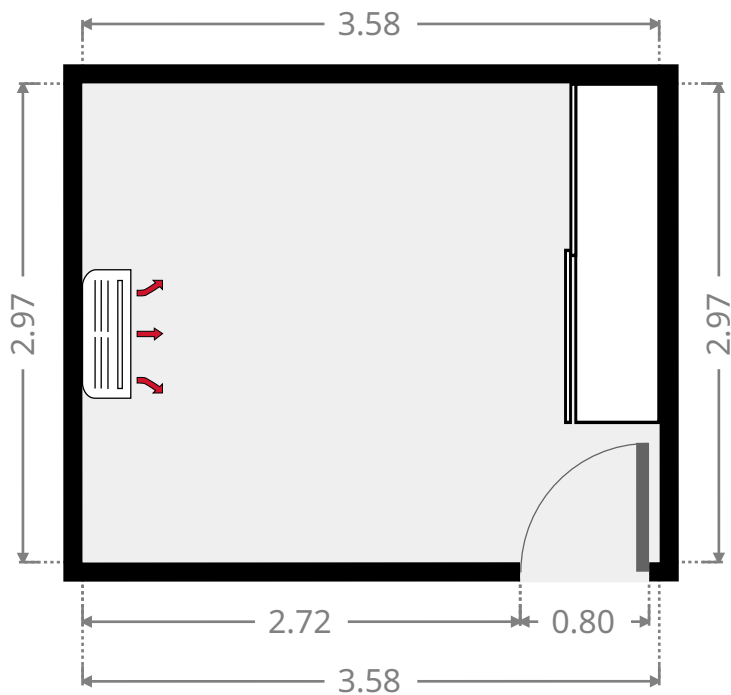
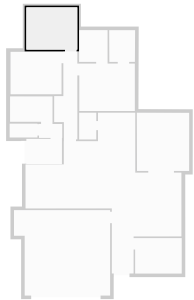

▼ **Master Bedroom**
Ground Floor

WIDTH: 3.90 m • LENGTH: 3.33 m
AREA: 12.99 m² • PERIMETER: 14.46 m

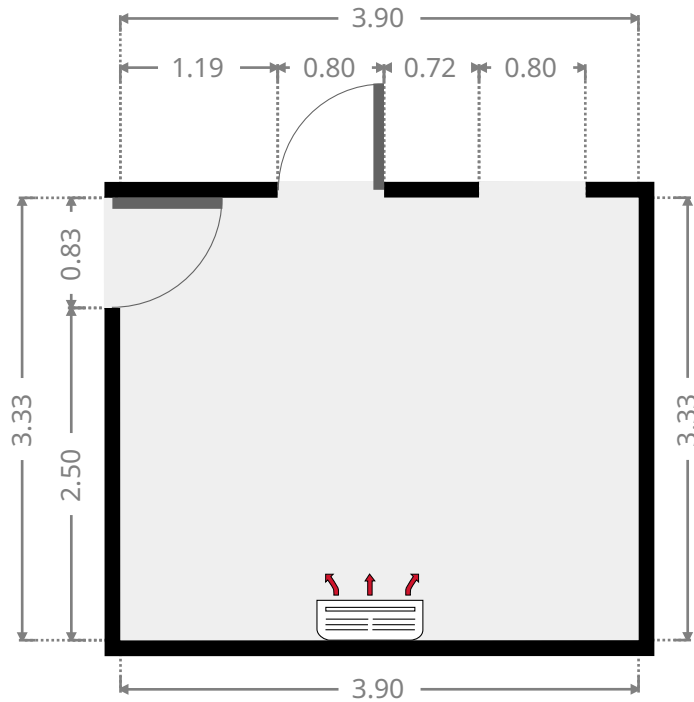
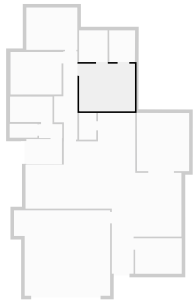

▼ **Bathroom**
Ground Floor

WIDTH: 2.00 m • LENGTH: 2.23 m
AREA: 4.46 m² • PERIMETER: 8.46 m

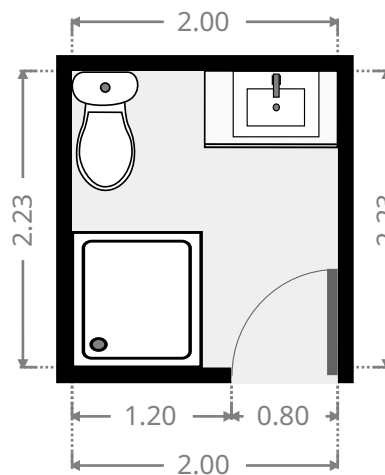
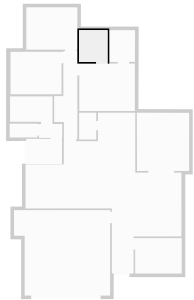

▼ Closet Ground Floor

WIDTH: 1.82 m • LENGTH: 2.23 m
AREA: 4.03 m² • PERIMETER: 8.07 m

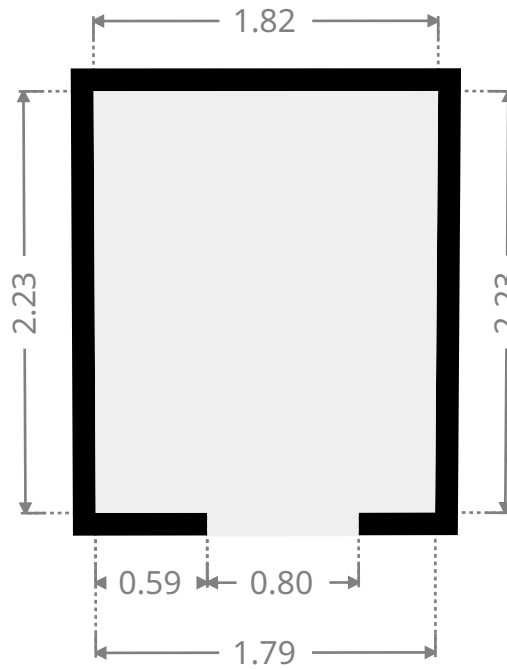
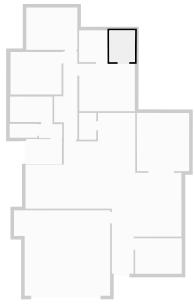

▼ Pantry Ground Floor

WIDTH: 1.20 m • LENGTH: 1.88 m
AREA: 2.26 m² • PERIMETER: 6.16 m

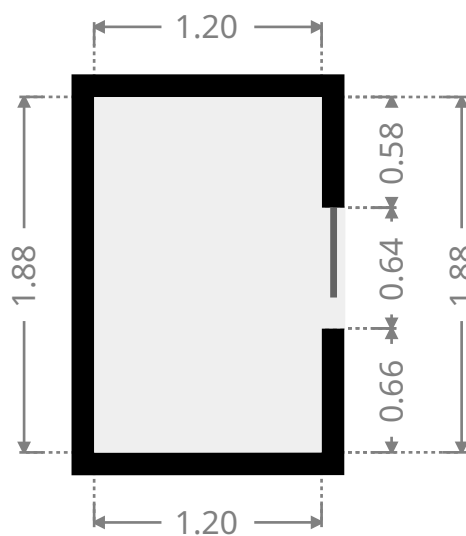
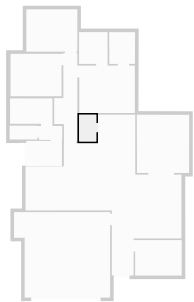

▼ Other Ground Floor

WIDTH: 3.68 m • LENGTH: 4.09 m
AREA: 14.99 m² • PERIMETER: 15.51 m

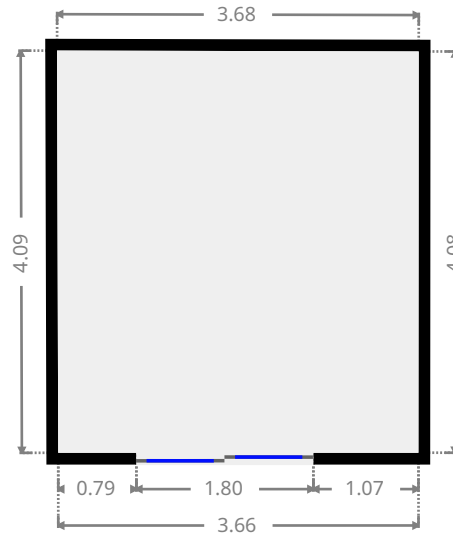
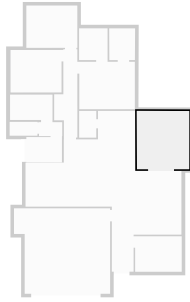

▼ Garage Ground Floor

WIDTH: 6.75 m • LENGTH: 6.00 m
AREA: 37.35 m² • PERIMETER: 25.50 m

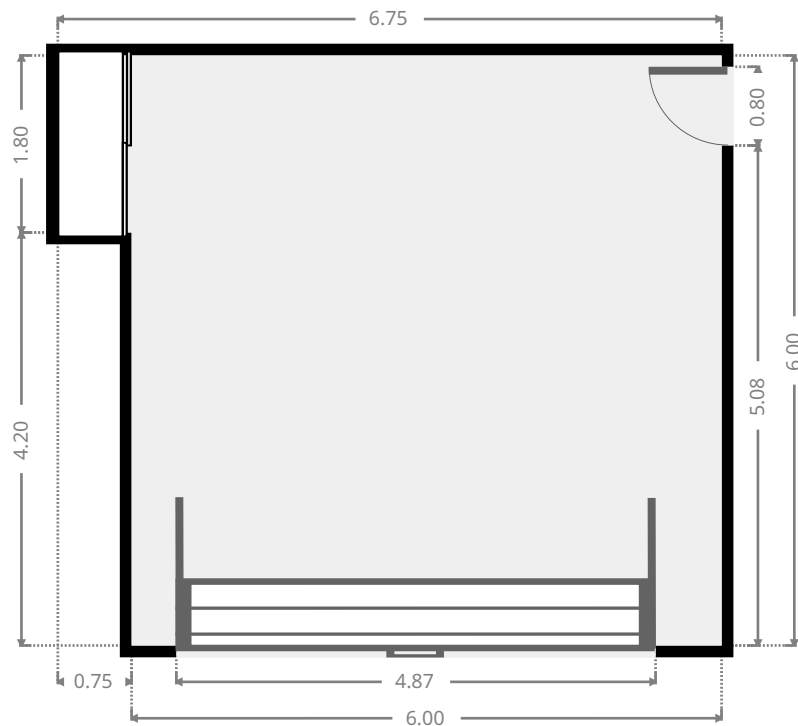
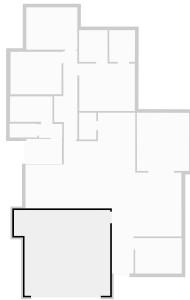

▼ Study Ground Floor

WIDTH: 3.27 m • LENGTH: 2.49 m
AREA: 8.14 m² • PERIMETER: 11.52 m

