

12 Lucas Street

SUBMITTED BY

Ray White Rockhampton Casey
stockers@cqoz.com

CREATED ON

2022-05-10

Floors

2

▼ Ground Floor

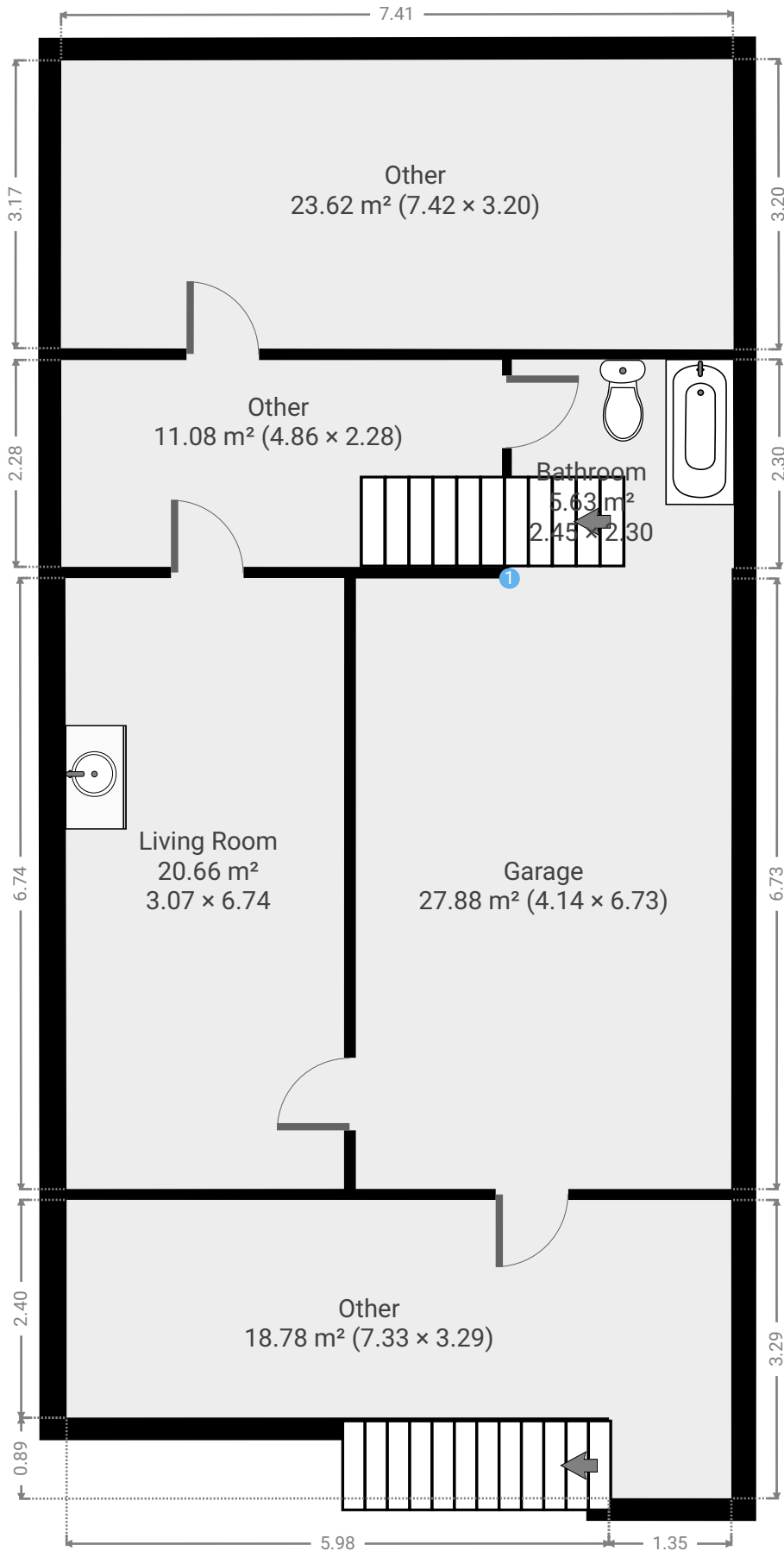

▼ **Bathroom**
Ground Floor

WIDTH: 2.45 m • LENGTH: 2.30 m
AREA: 5.63 m² • PERIMETER: 9.50 m

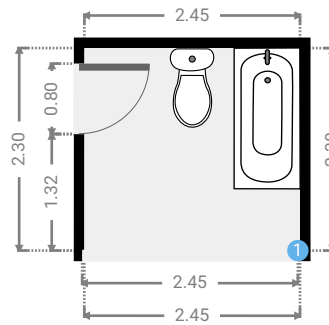
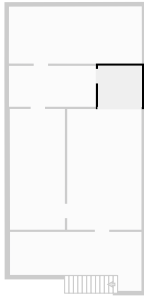

▼ **Garage**
Ground Floor

WIDTH: 4.14 m • LENGTH: 6.73 m
AREA: 27.88 m² • PERIMETER: 21.74 m

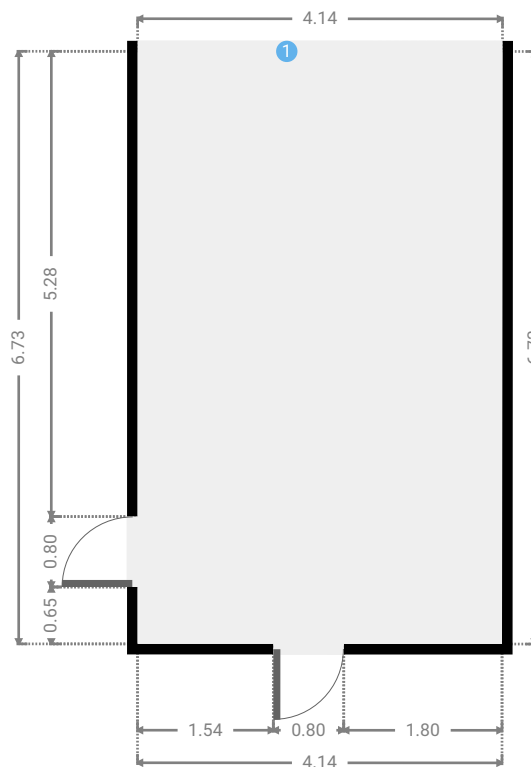
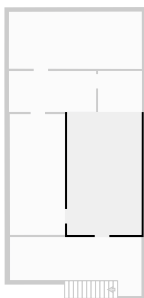

▼ Garage/Ground Floor

1 OPENING

Height
0.00 m



▼ Living Room
Ground Floor

WIDTH: 3.07 m • LENGTH: 6.74 m
AREA: 20.66 m² • PERIMETER: 19.61 m

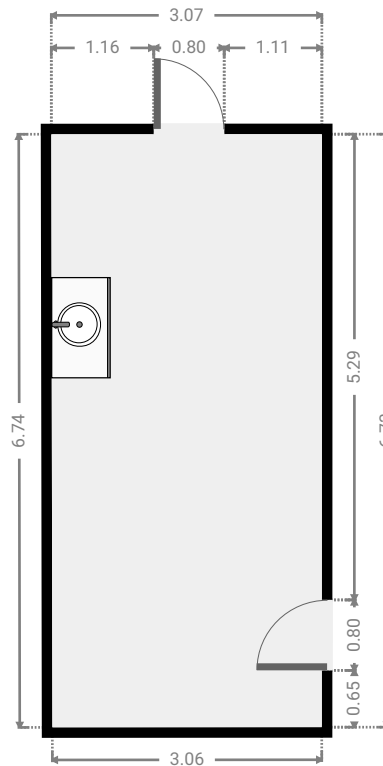
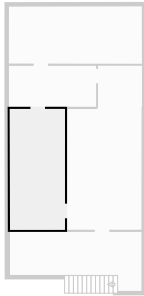

▼ Other
Ground Floor

WIDTH: 4.86 m • LENGTH: 2.28 m
AREA: 11.08 m² • PERIMETER: 14.28 m

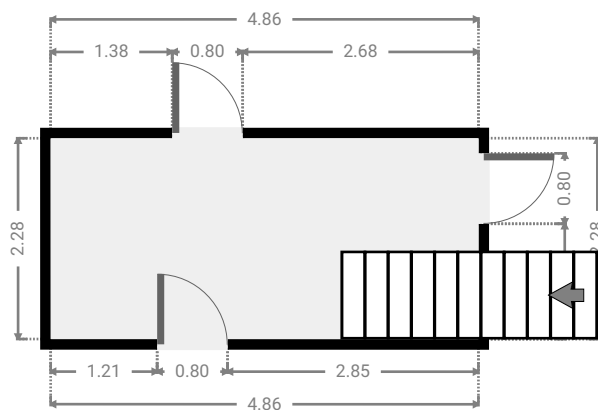
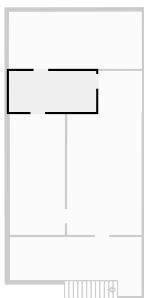

▼ Other
Ground Floor

WIDTH: 7.42 m • LENGTH: 3.20 m
AREA: 23.62 m² • PERIMETER: 21.20 m

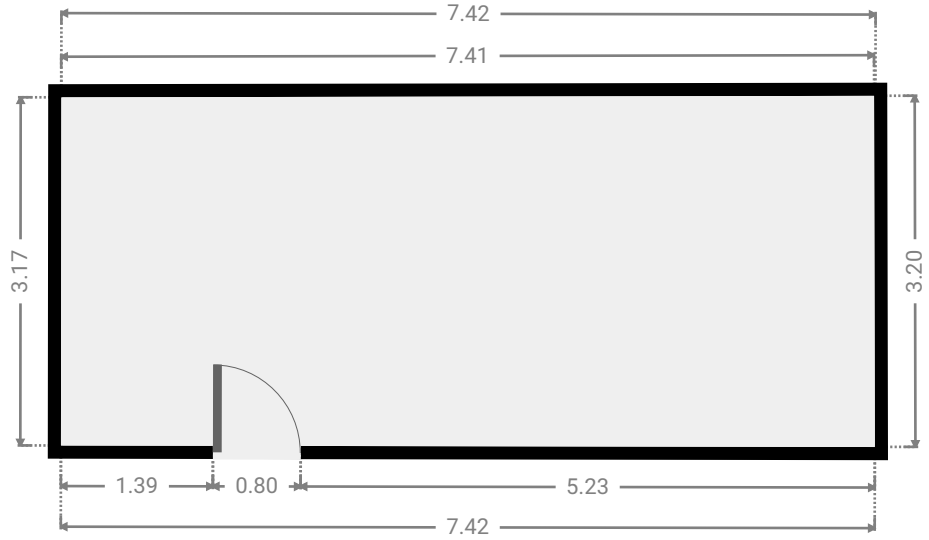

▼ Other
Ground Floor

WIDTH: 7.33 m • LENGTH: 3.29 m
AREA: 18.78 m² • PERIMETER: 21.24 m

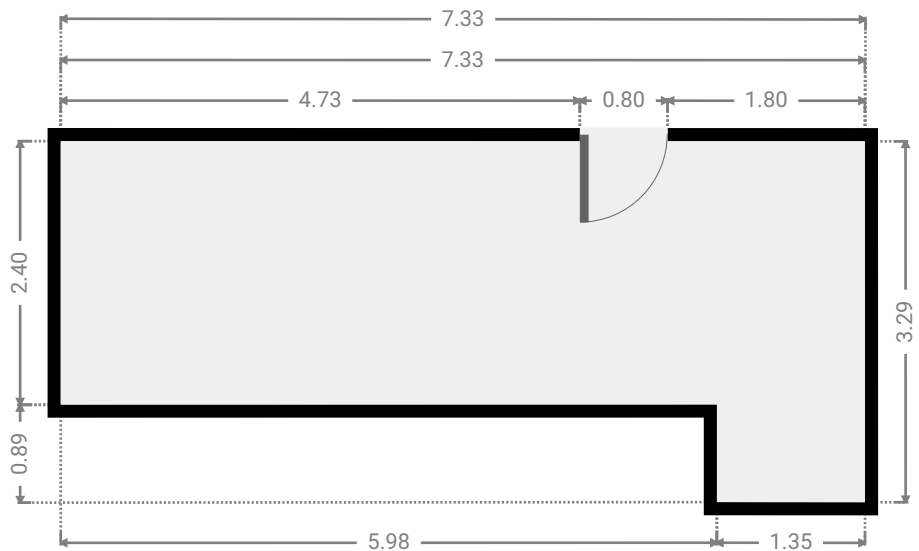

▼ 1st Floor

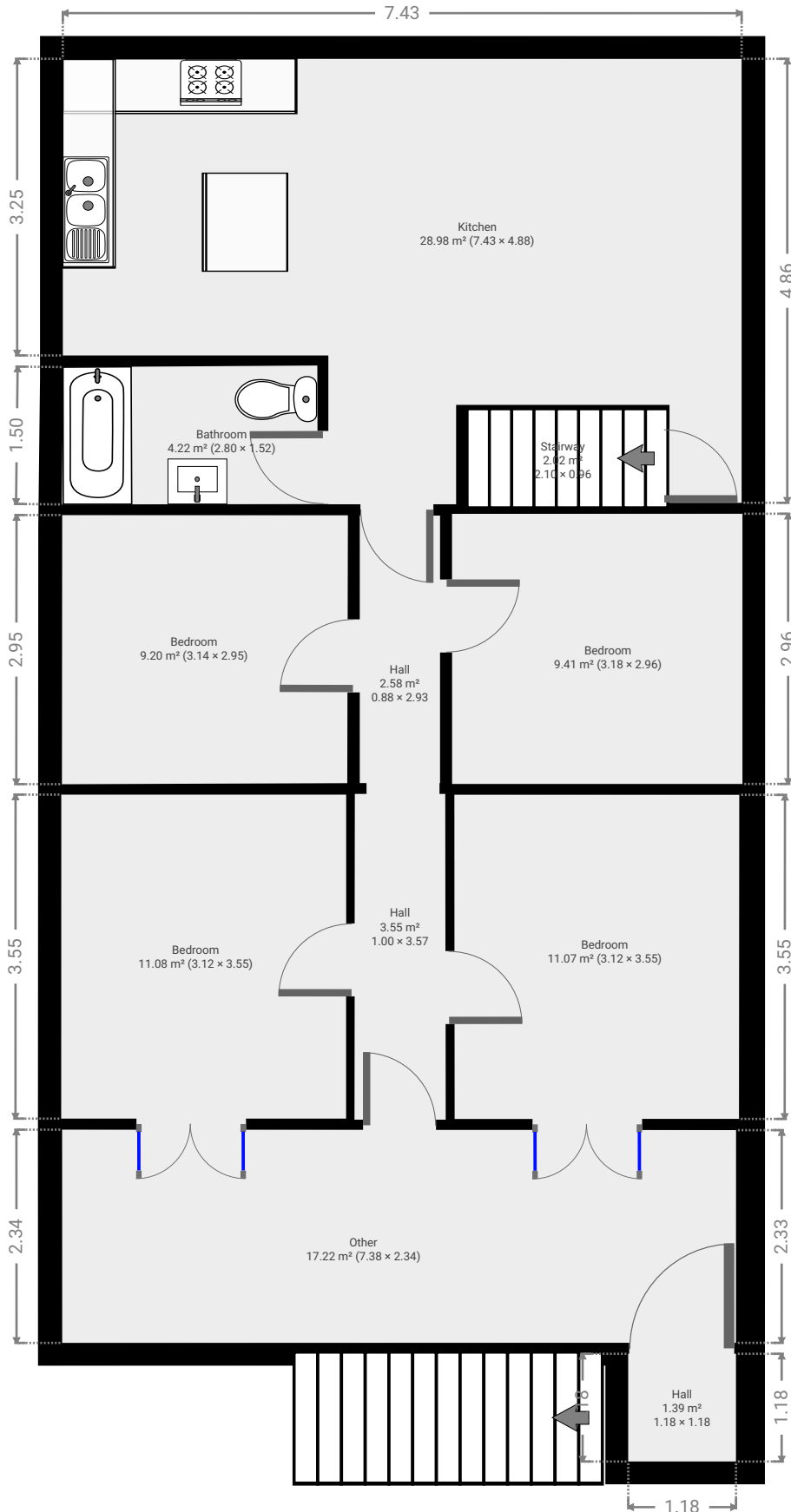

▼ Bathroom
1st Floor

WIDTH: 2.80 m • LENGTH: 1.52 m
AREA: 4.22 m² • PERIMETER: 8.61 m

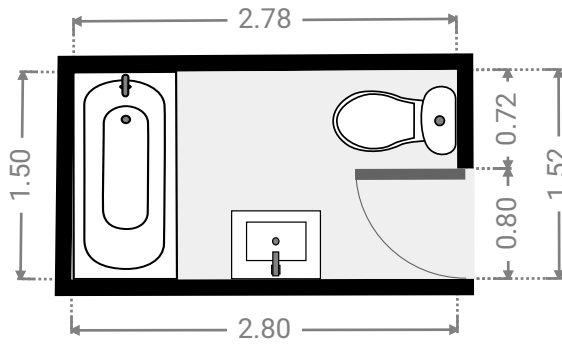
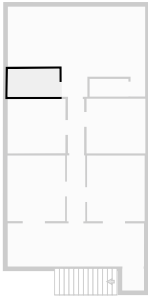

▼ Bedroom
1st Floor

WIDTH: 3.12 m • LENGTH: 3.55 m
AREA: 11.07 m² • PERIMETER: 13.34 m

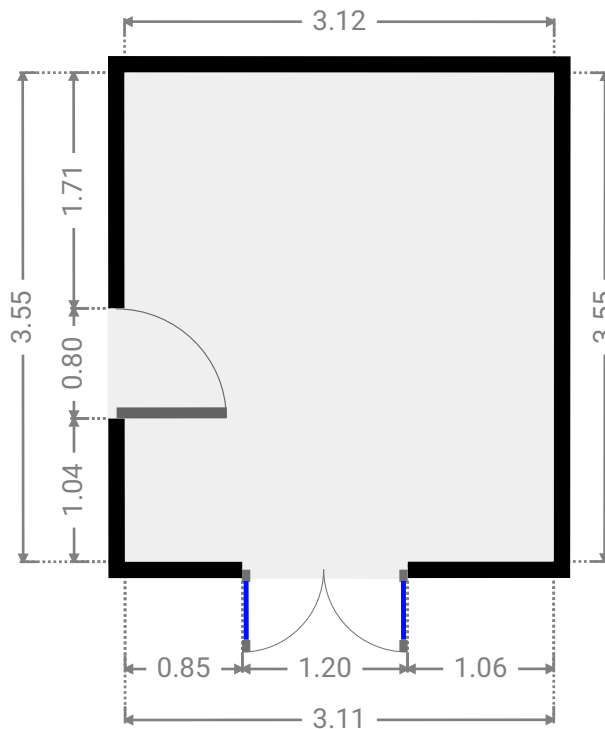
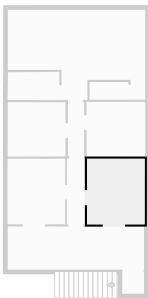

▼ Bedroom
1st Floor

WIDTH: 3.12 m • LENGTH: 3.55 m
AREA: 11.08 m² • PERIMETER: 13.34 m

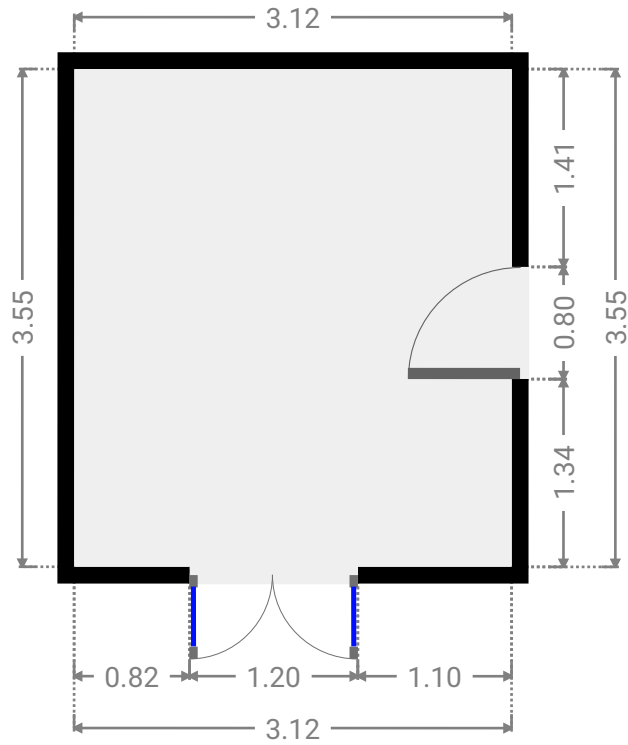
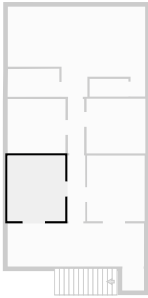

▼ Bedroom
1st Floor

WIDTH: 3.18 m • LENGTH: 2.96 m
AREA: 9.41 m² • PERIMETER: 12.28 m

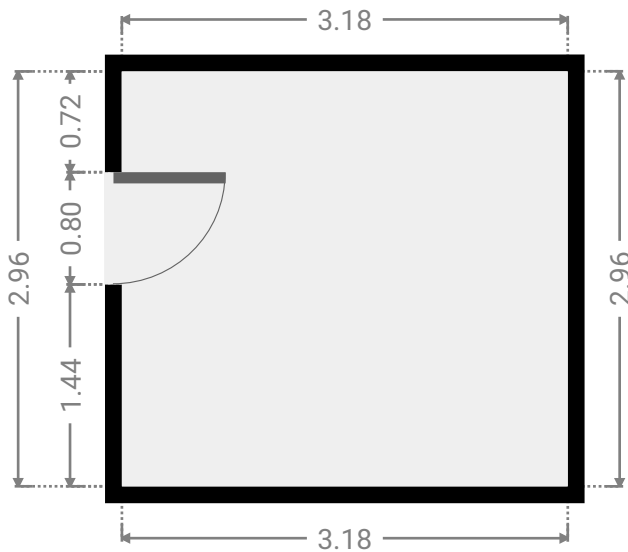
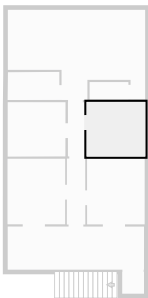

▼ **Bedroom**
1st Floor

WIDTH: 3.14 m • LENGTH: 2.95 m
AREA: 9.20 m² • PERIMETER: 12.14 m

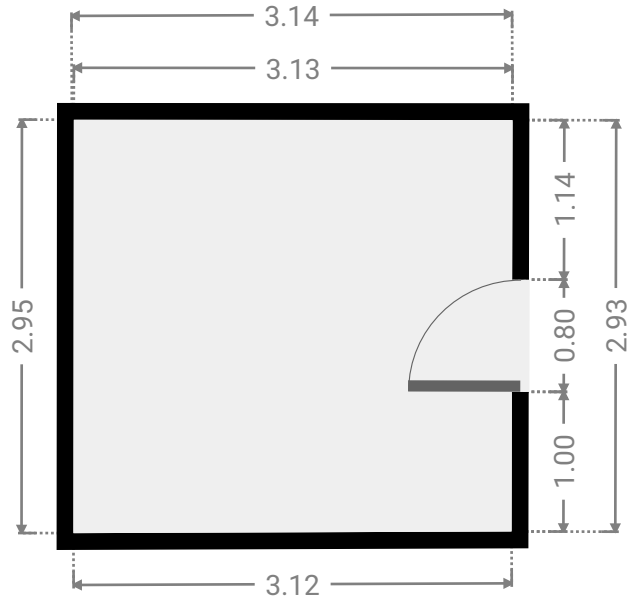
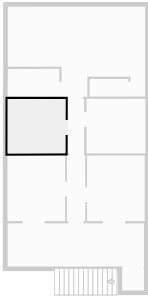

▼ **Hall**
1st Floor

WIDTH: 1.00 m • LENGTH: 3.57 m
AREA: 3.55 m² • PERIMETER: 9.13 m

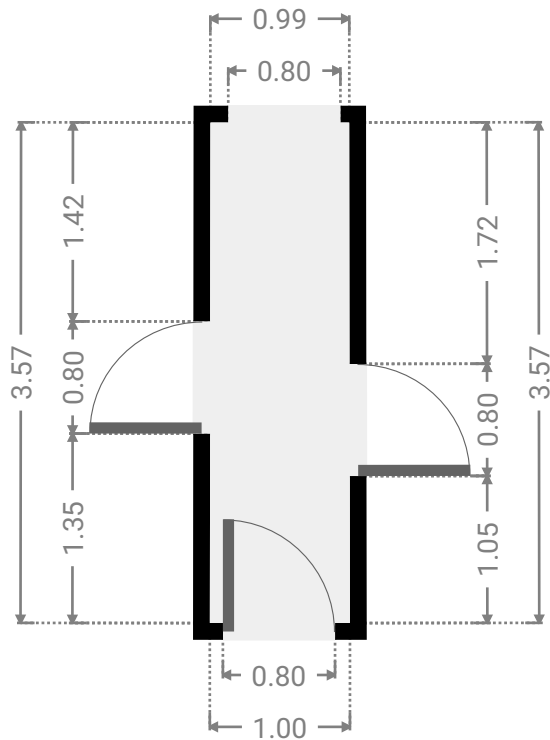
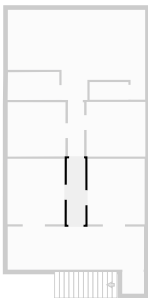

▼ Hall
1st Floor

WIDTH: 0.88 m • LENGTH: 2.93 m
AREA: 2.58 m² • PERIMETER: 7.62 m

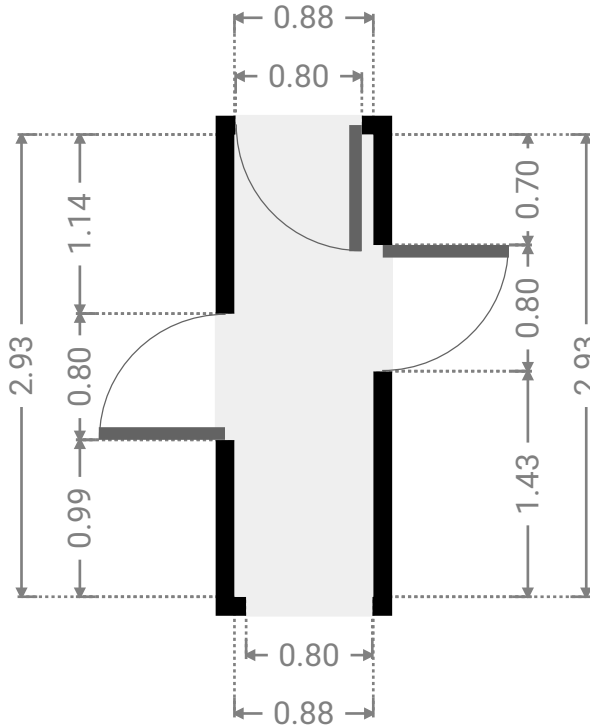
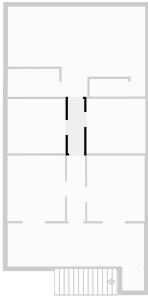

▼ Hall
1st Floor

WIDTH: 1.18 m • LENGTH: 1.18 m
AREA: 1.39 m² • PERIMETER: 4.72 m

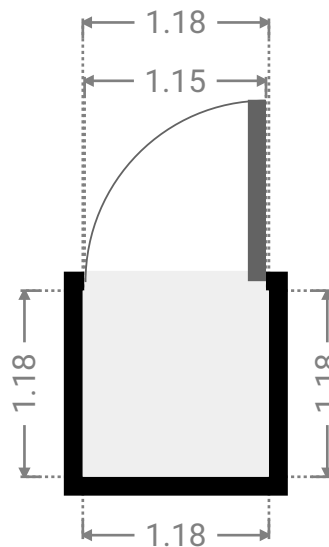
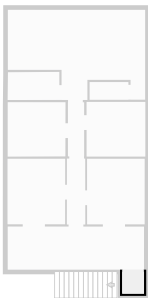

▼ Kitchen
1st Floor

WIDTH: 7.43 m • LENGTH: 4.88 m
AREA: 28.98 m² • PERIMETER: 26.77 m

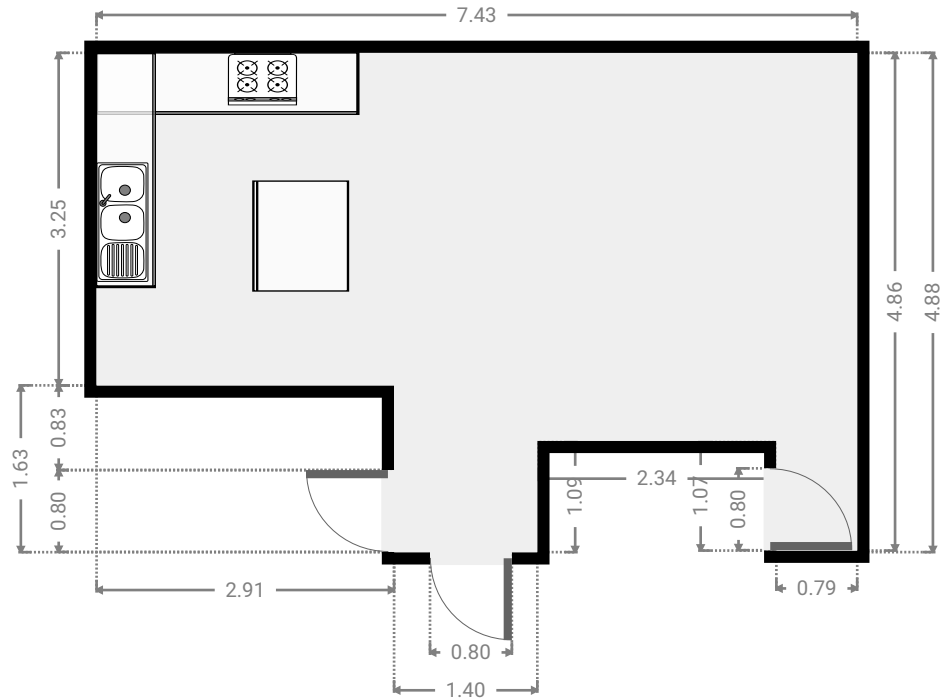
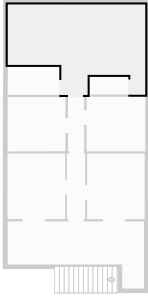

▼ Other
1st Floor

WIDTH: 7.38 m • LENGTH: 2.34 m
AREA: 17.22 m² • PERIMETER: 19.43 m

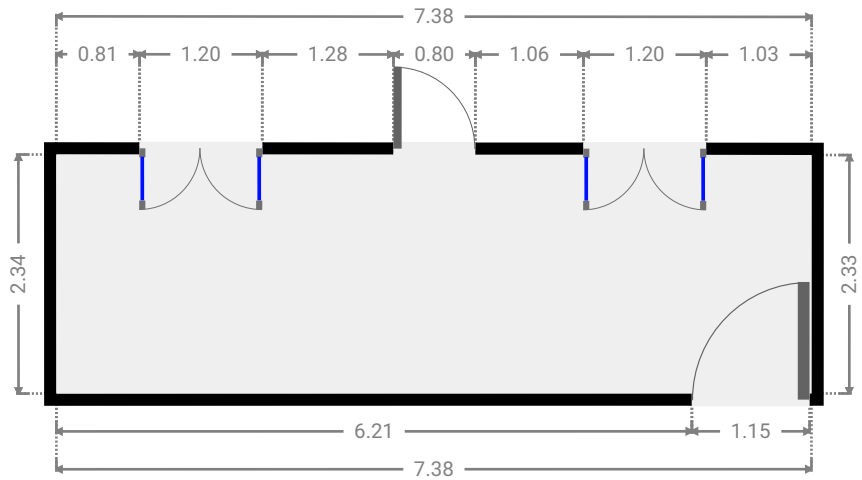
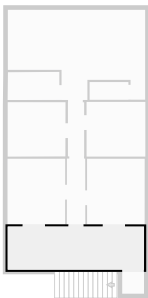

▼ Stairway
1st Floor

WIDTH: 2.10 m • LENGTH: 0.96 m
AREA: 2.02 m² • PERIMETER: 6.12 m

