

12 Elida Street

Ground Floor

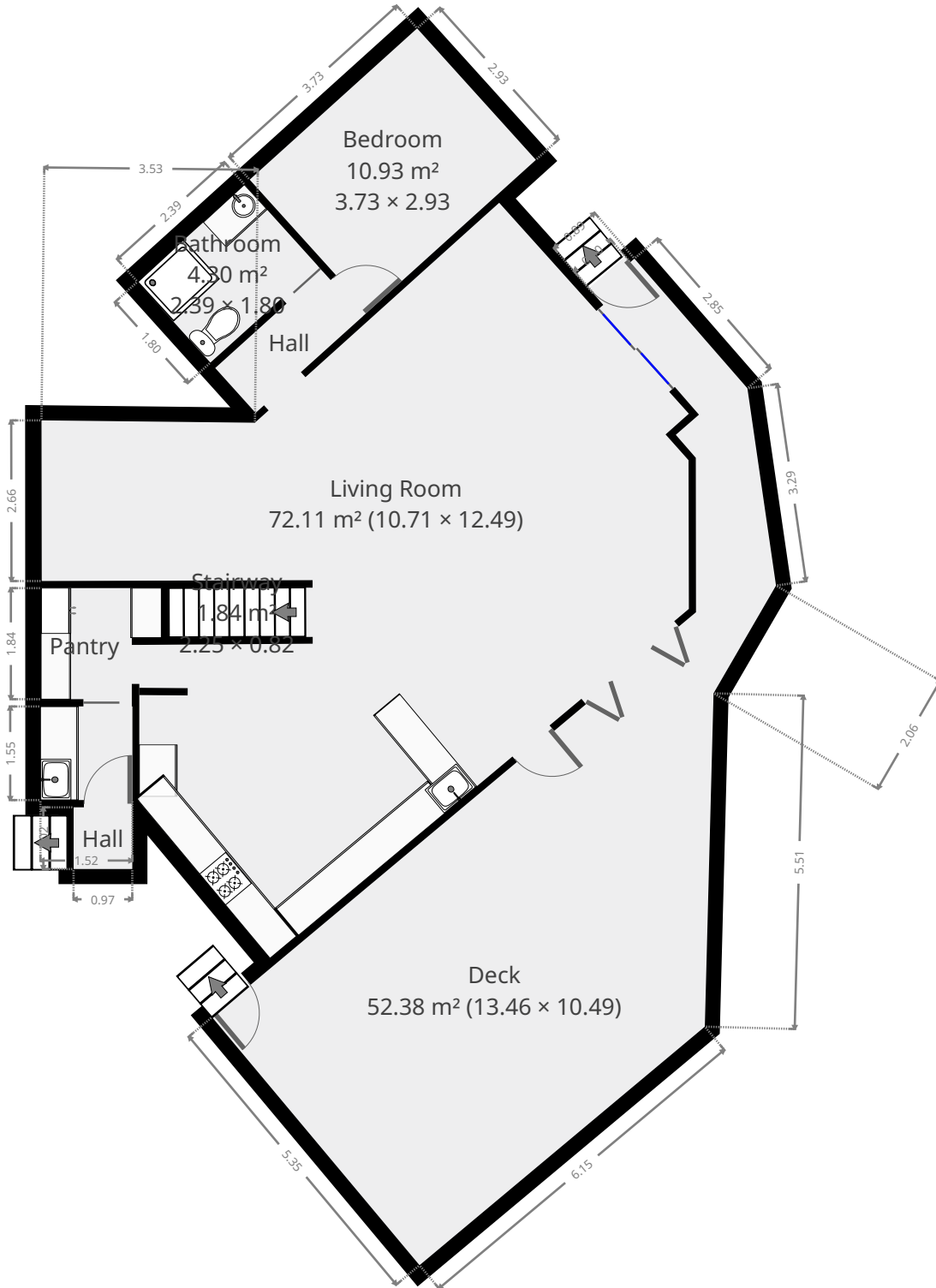

THIS FLOORPLAN IS PROVIDED WITHOUT WARRANTY OF ANY KIND. SENSOPIA DISCLAIMS ANY WARRANTY INCLUDING, WITHOUT LIMITATION, SATISFACTORY QUALITY OR ACCURACY OF DIMENSIONS.



12 Elida Street

Hall

Width: 1.00 m
Length: 2.39 m
Area: 2.39 m²
Perimeter: 6.78 m

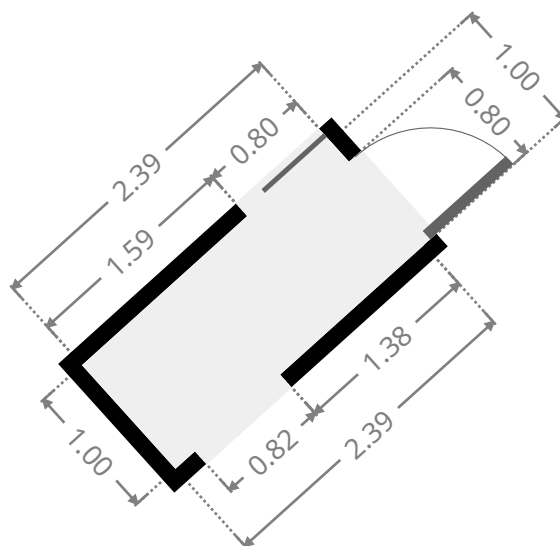
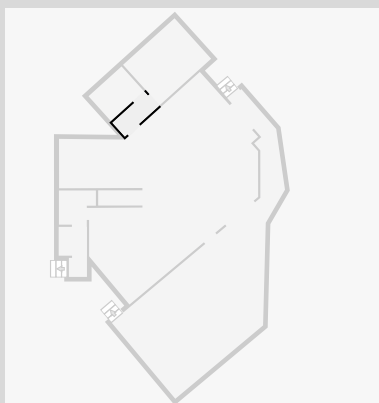

Bedroom

Width: 2.93 m
Length: 3.73 m
Area: 10.93 m²
Perimeter: 13.32 m

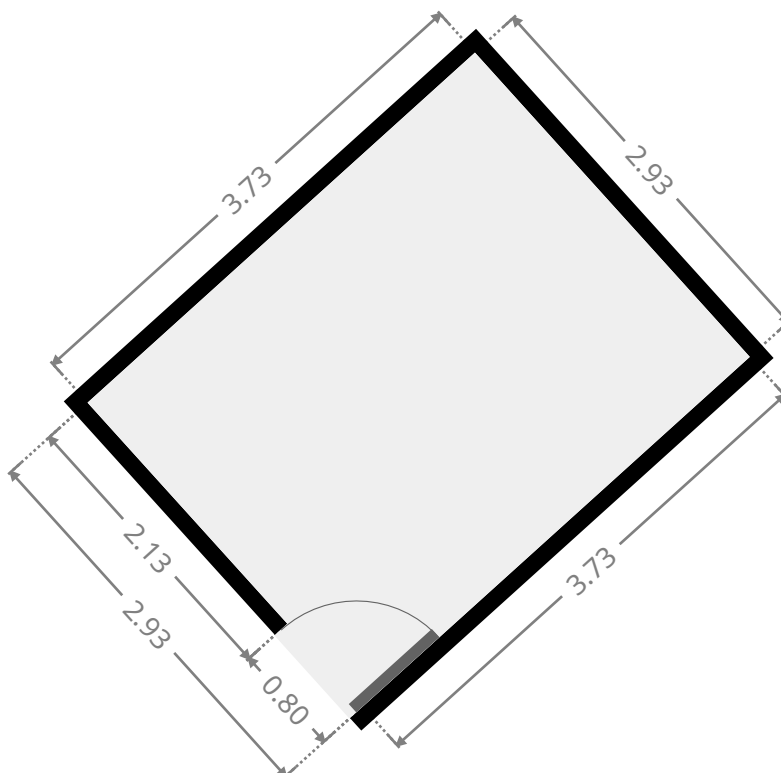
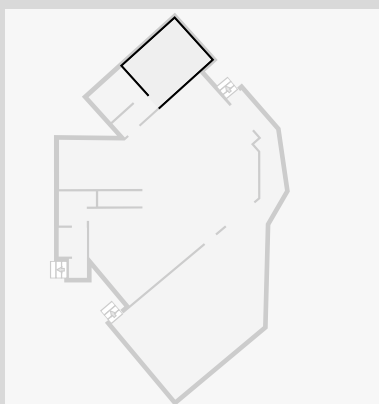

12 Elida Street

Bathroom

Width: 1.80 m
Length: 2.39 m
Area: 4.30 m²
Perimeter: 8.38 m

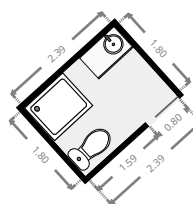
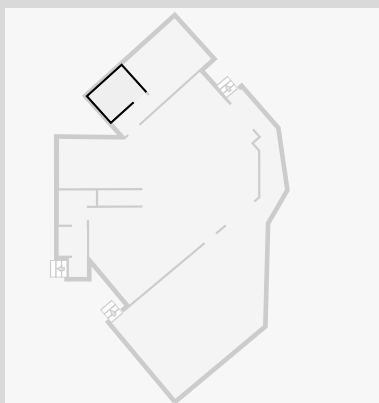

Living Room

Width: 10.71 m
Length: 12.49 m
Area: 72.11 m²
Perimeter: 43.25 m

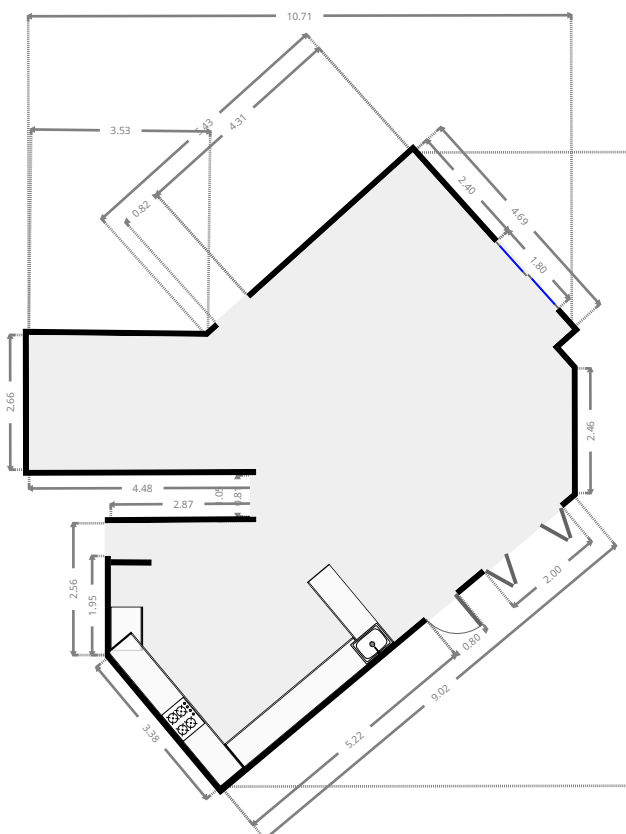
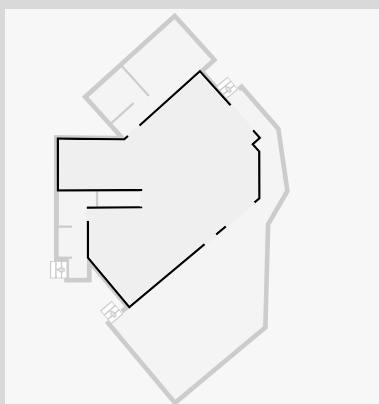

THIS FLOORPLAN IS PROVIDED WITHOUT WARRANTY OF ANY KIND. SENSOPIA DISCLAIMS ANY WARRANTY INCLUDING, WITHOUT LIMITATION, SATISFACTORY QUALITY OR ACCURACY OF DIMENSIONS.

12 Elida Street

Stairway

| | |
|-----------|---------------------|
| Width: | 0.82 m |
| Length: | 2.25 m |
| Area | 1.84 m ² |
| Perimeter | 6.14 m |

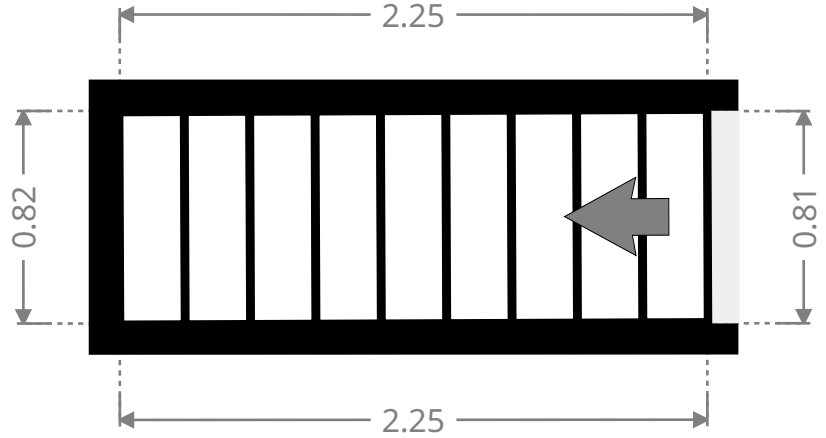
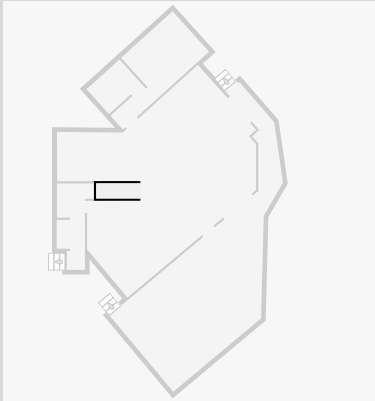

Pantry

| | |
|-----------|---------------------|
| Width: | 1.84 m |
| Length: | 1.99 m |
| Area | 3.15 m ² |
| Perimeter | 7.65 m |

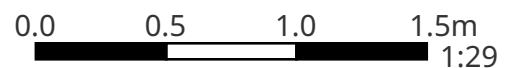
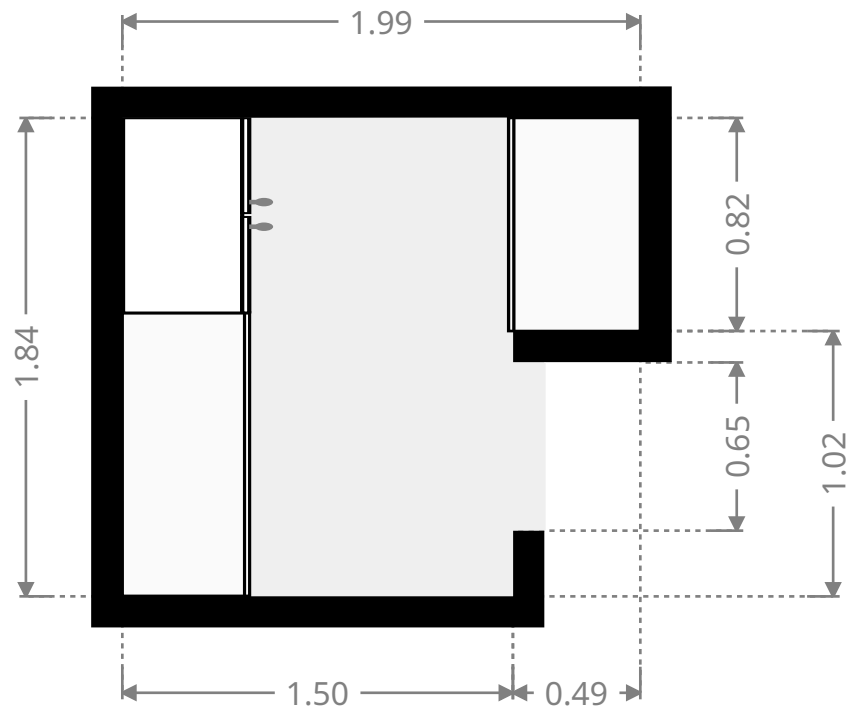
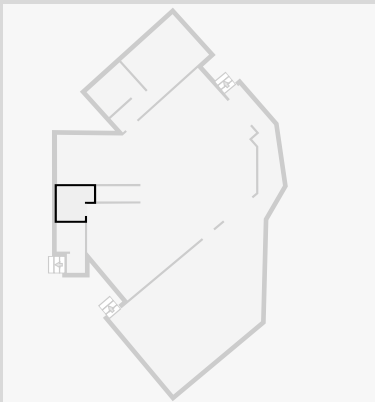

THIS FLOORPLAN IS PROVIDED WITHOUT WARRANTY OF ANY KIND. SENSOPIA DISCLAIMS ANY WARRANTY INCLUDING, WITHOUT LIMITATION, SATISFACTORY QUALITY OR ACCURACY OF DIMENSIONS.

12 Elida Street

Laundry Room

Width: 1.52 m
Length: 1.55 m
Area: 2.35 m²
Perimeter: 6.13 m

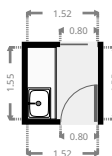
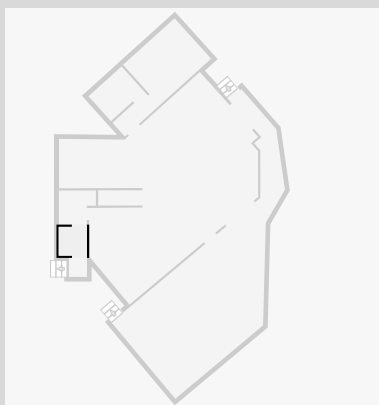

Deck

Width: 10.49 m
Length: 13.46 m
Area: 52.38 m²
Perimeter: 42.74 m

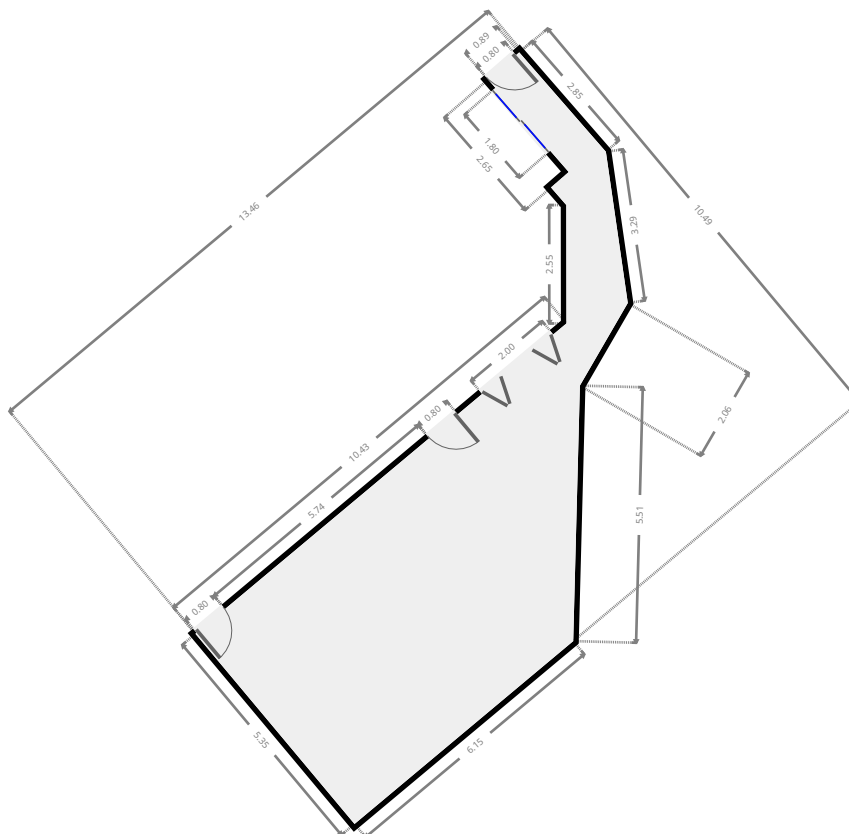
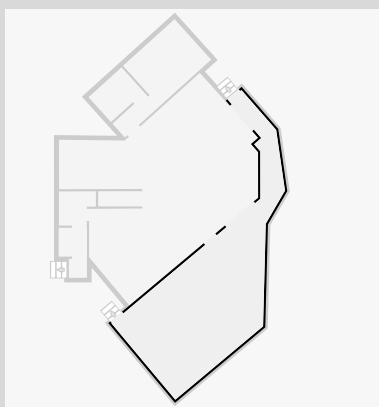

THIS FLOORPLAN IS PROVIDED WITHOUT WARRANTY OF ANY KIND. SENSOPIA DISCLAIMS ANY WARRANTY INCLUDING, WITHOUT LIMITATION, SATISFACTORY QUALITY OR ACCURACY OF DIMENSIONS.

12 Elida Street

Hall

Width: 0.97 m
Length: 1.02 m
Area: 0.99 m²
Perimeter: 3.98 m

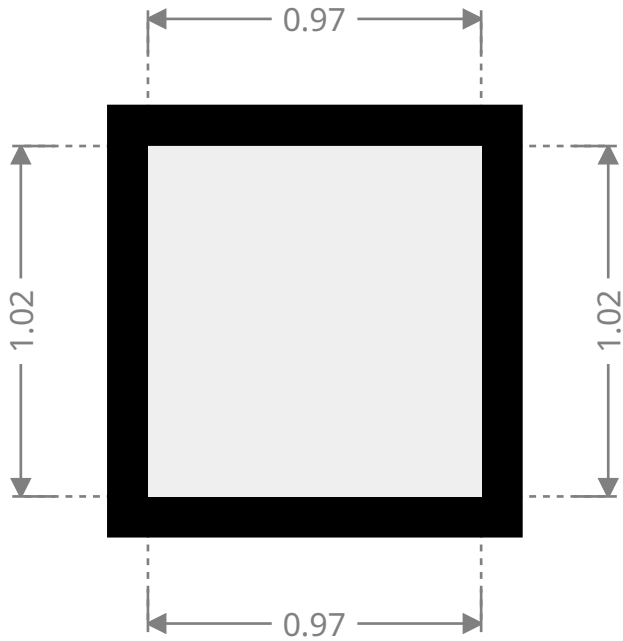
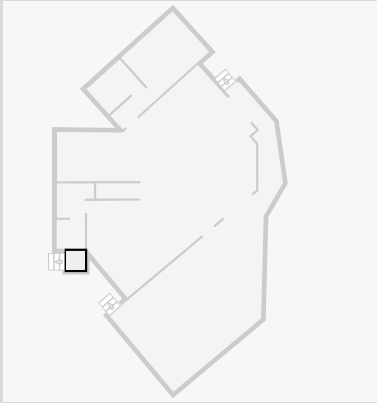

12 Elida Street

1st Floor

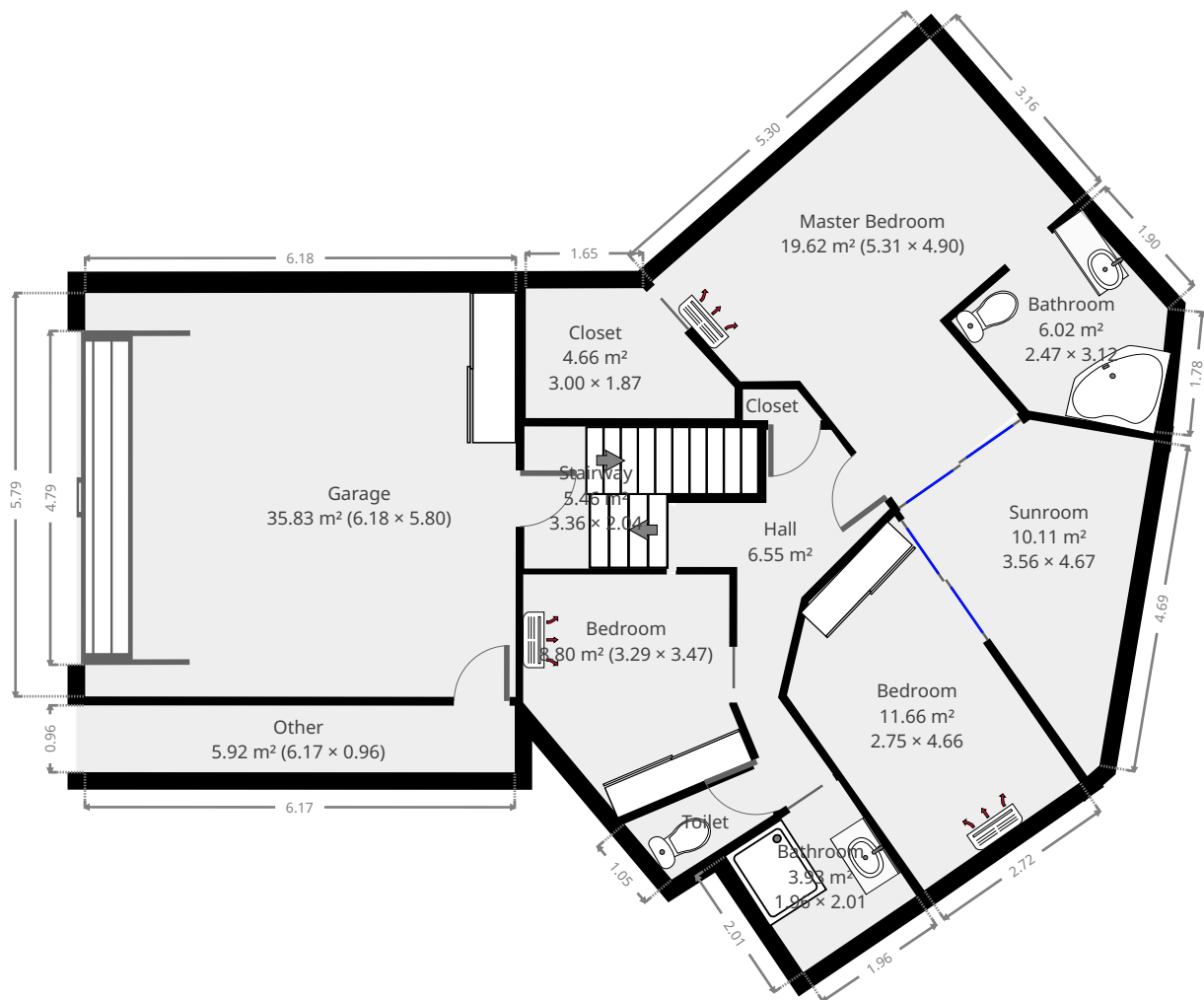

THIS FLOORPLAN IS PROVIDED WITHOUT WARRANTY OF ANY KIND. SENSOPIA DISCLAIMS ANY WARRANTY INCLUDING, WITHOUT LIMITATION, SATISFACTORY QUALITY OR ACCURACY OF DIMENSIONS.



12 Elida Street

Garage

Width: 5.80 m
 Length: 6.18 m
 Area: 35.83 m²
 Perimeter: 23.96 m

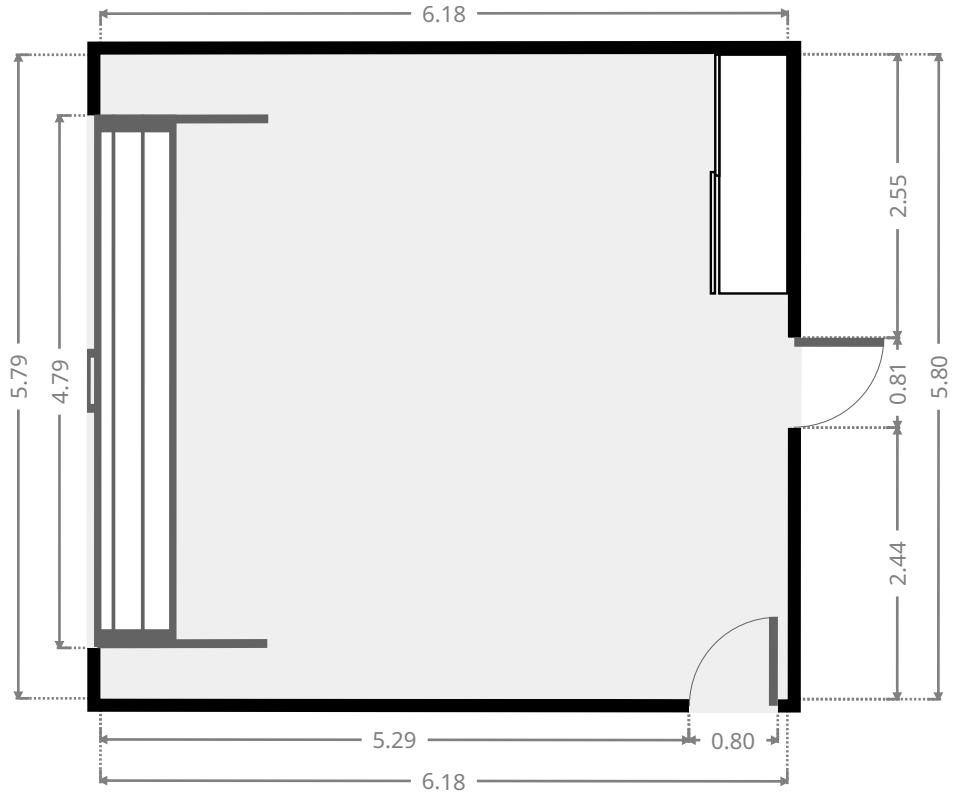
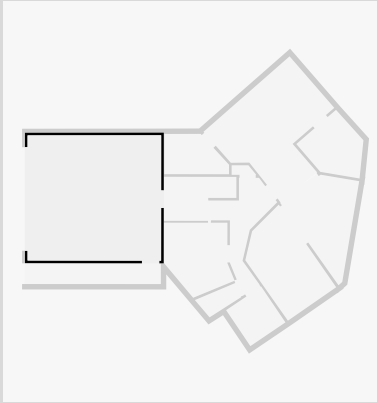

Other

Width: 0.96 m
 Length: 6.17 m
 Area: 5.92 m²
 Perimeter: 14.26 m

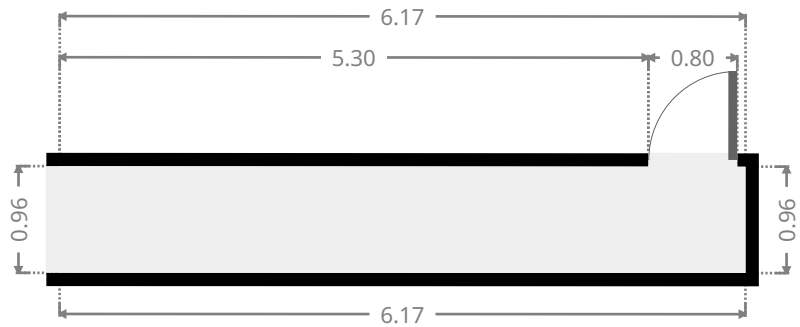
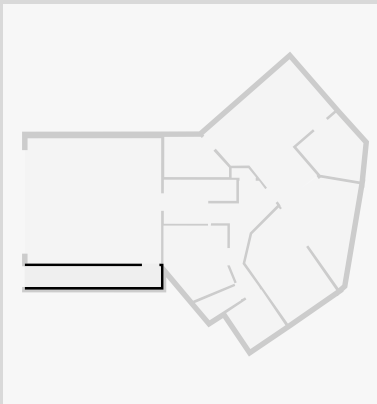

12 Elida Street

Stairway

| | |
|-----------|---------------------|
| Width: | 2.04 m |
| Length: | 3.36 m |
| Area | 5.46 m ² |
| Perimeter | 10.79 m |

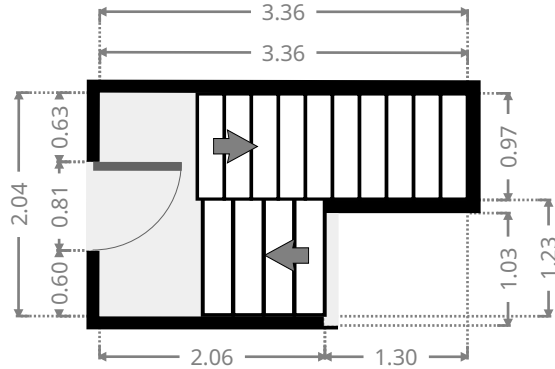
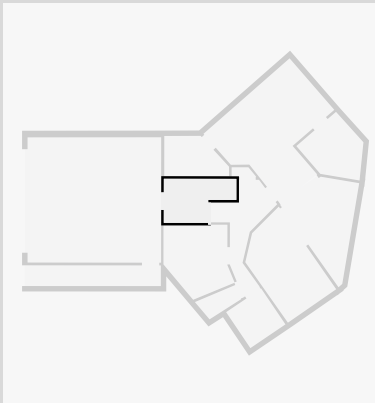

Hall

| | |
|-----------|---------------------|
| Width: | 3.07 m |
| Length: | 5.45 m |
| Area | 6.55 m ² |
| Perimeter | 15.62 m |

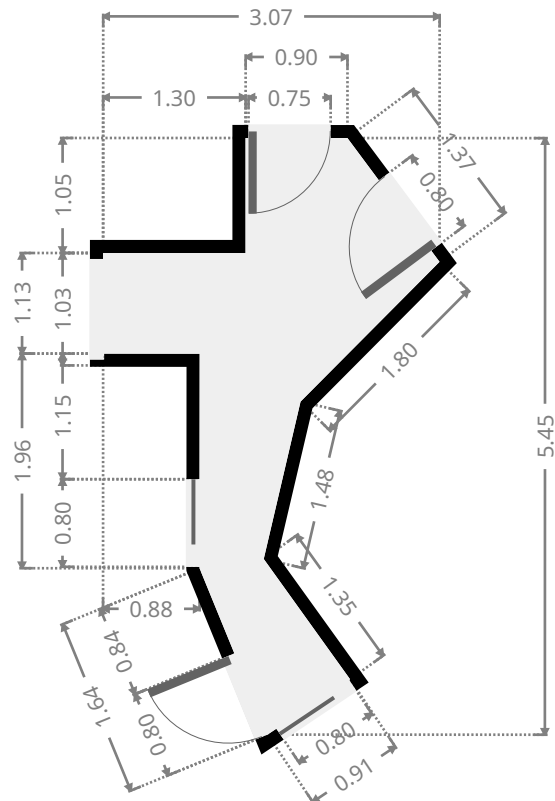
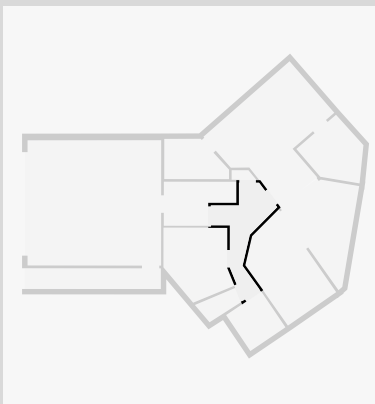

THIS FLOORPLAN IS PROVIDED WITHOUT WARRANTY OF ANY KIND. SENSOPIA DISCLAIMS ANY WARRANTY INCLUDING, WITHOUT LIMITATION, SATISFACTORY QUALITY OR ACCURACY OF DIMENSIONS.

12 Elida Street

Bedroom

Width: 3.29 m
 Length: 3.47 m
 Area: 8.80 m²
 Perimeter: 11.76 m

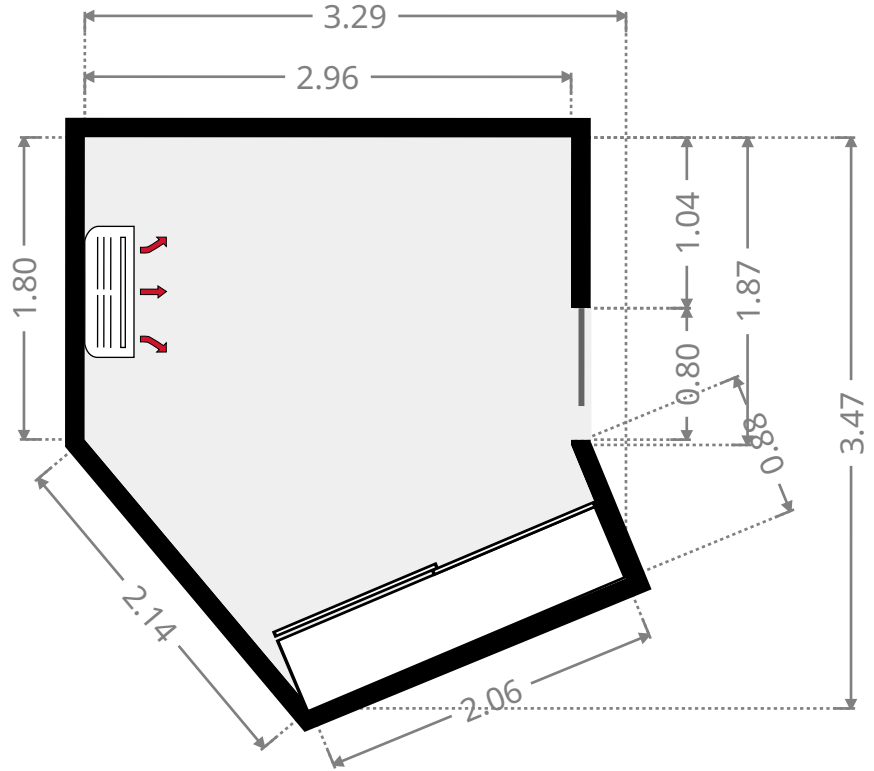
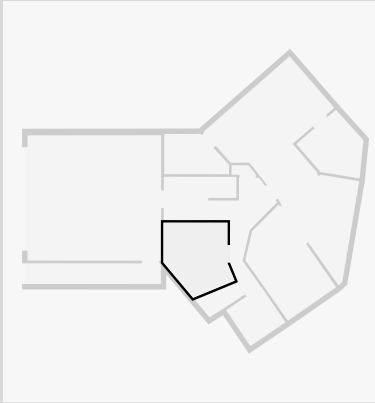

Toilet / Half Bath

Width: 1.00 m
 Length: 2.04 m
 Area: 1.63 m²
 Perimeter: 5.53 m

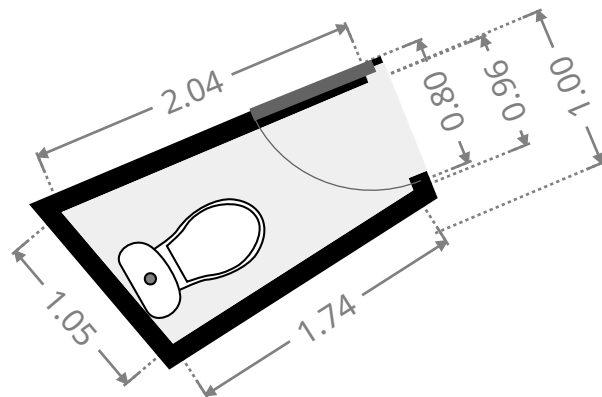
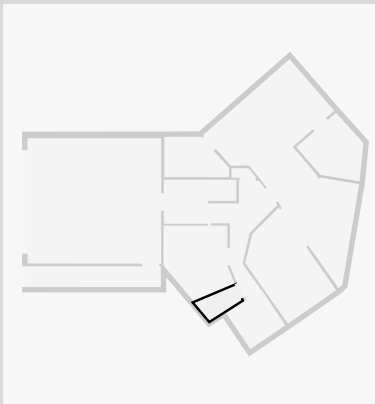

12 Elida Street

Bathroom

Width: 1.96 m
Length: 2.01 m
Area: 3.93 m²
Perimeter: 7.93 m

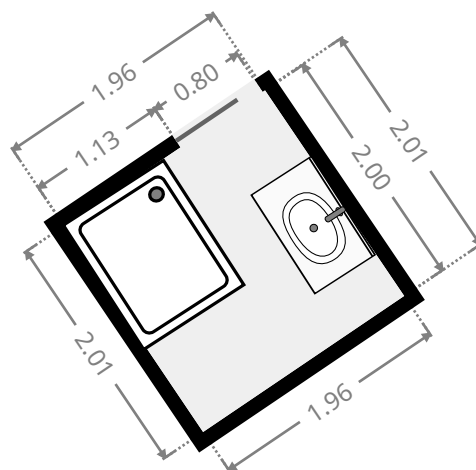
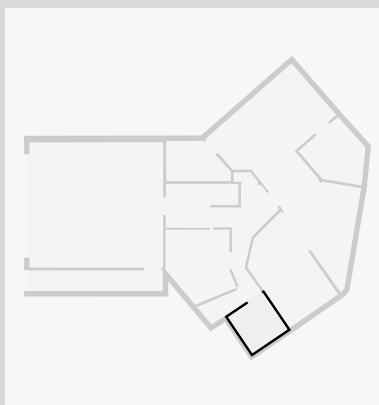

Bedroom

Width: 2.75 m
Length: 4.66 m
Area: 11.66 m²
Perimeter: 13.92 m

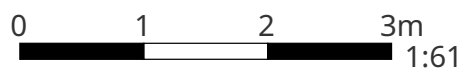
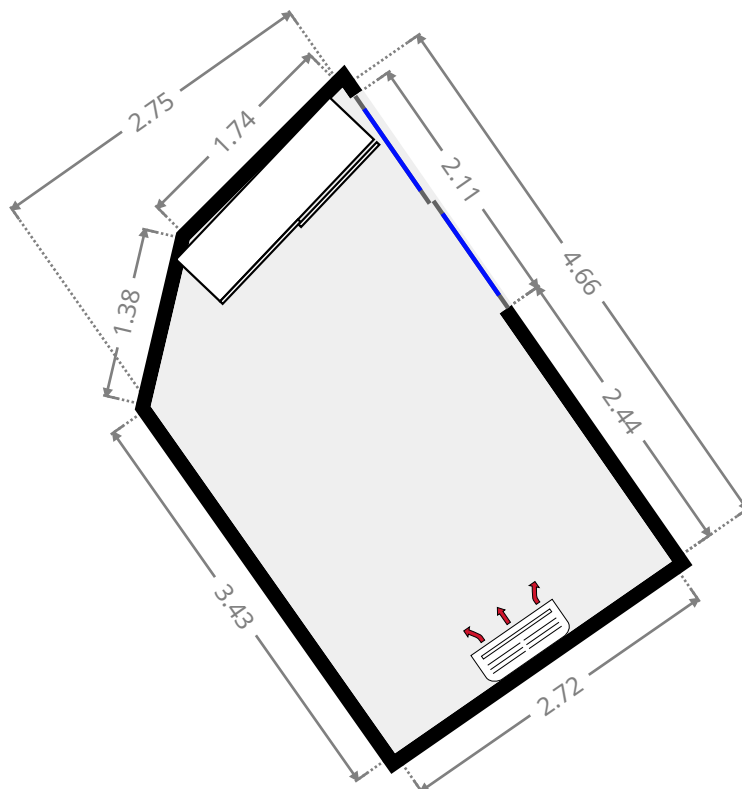
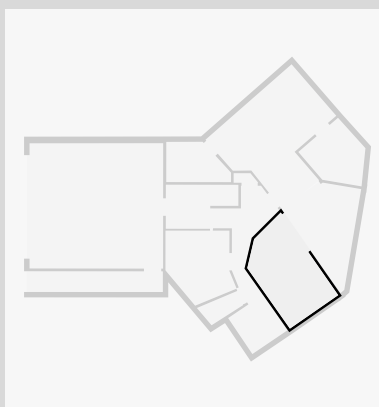

12 Elida Street

Sunroom

Width: 3.56 m
 Length: 4.67 m
 Area: 10.11 m²
 Perimeter: 13.72 m

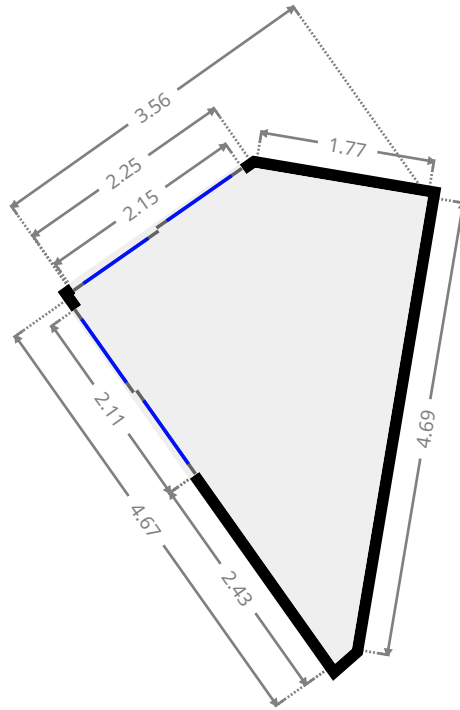
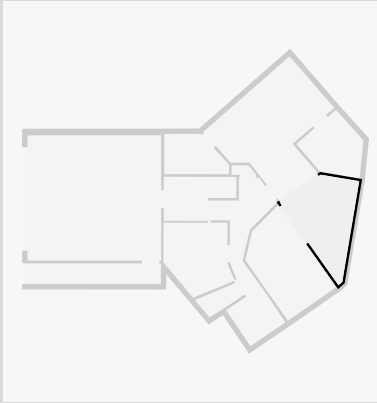

Master Bedroom

Width: 4.90 m
 Length: 5.31 m
 Area: 19.62 m²
 Perimeter: 19.99 m

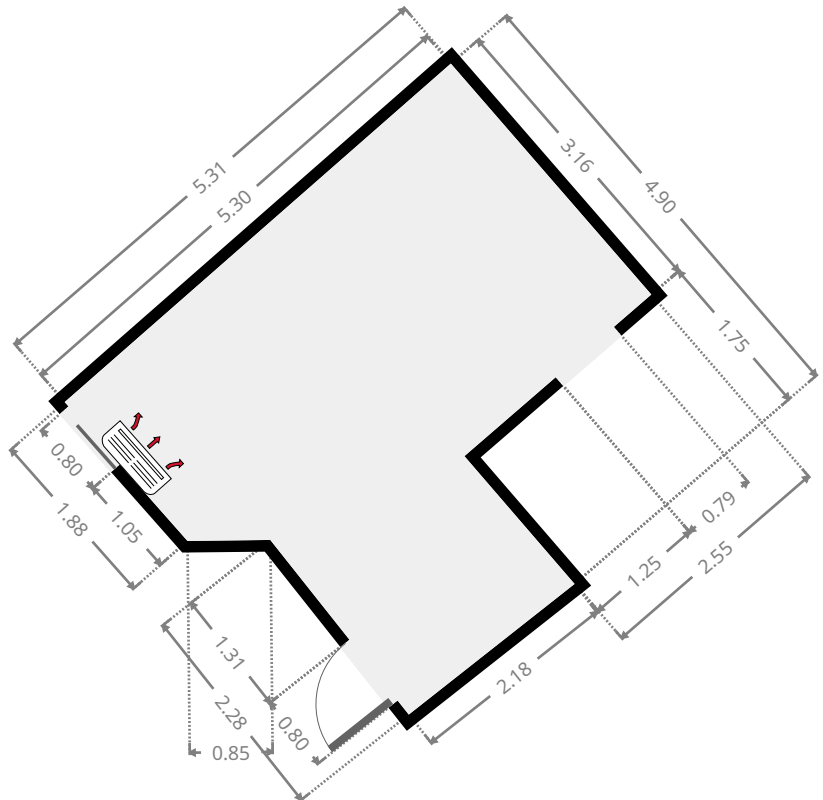
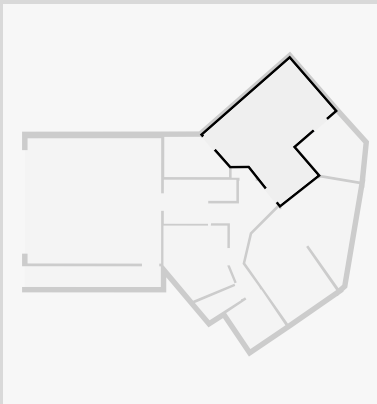

THIS FLOORPLAN IS PROVIDED WITHOUT WARRANTY OF ANY KIND. SENSOPIA DISCLAIMS ANY WARRANTY INCLUDING, WITHOUT LIMITATION, SATISFACTORY QUALITY OR ACCURACY OF DIMENSIONS.

12 Elida Street

Bathroom

Width: 2.47 m
 Length: 3.12 m
 Area: 6.02 m²
 Perimeter: 9.64 m

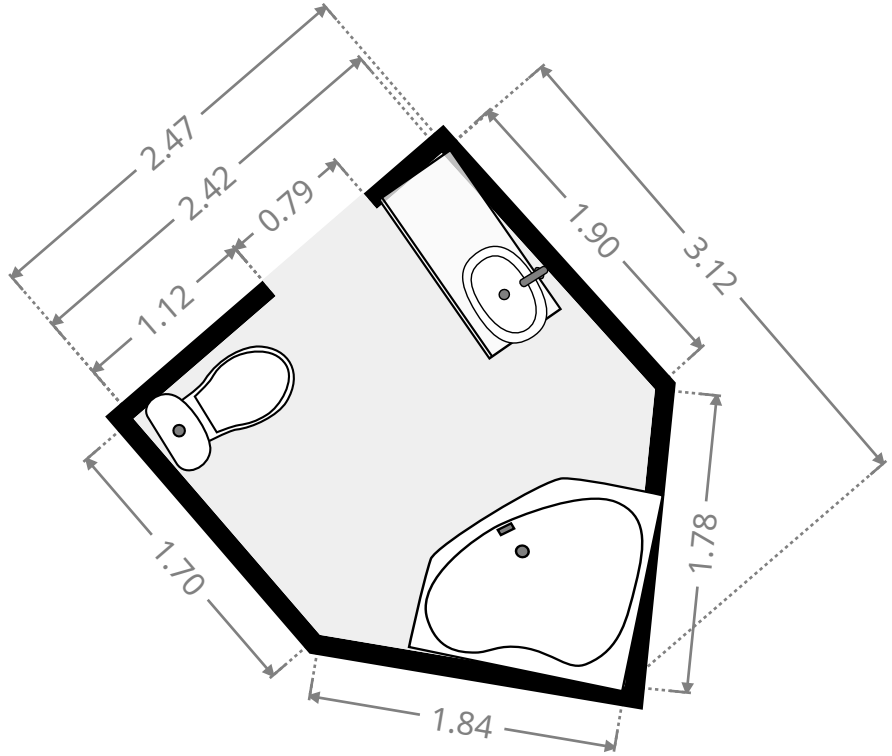
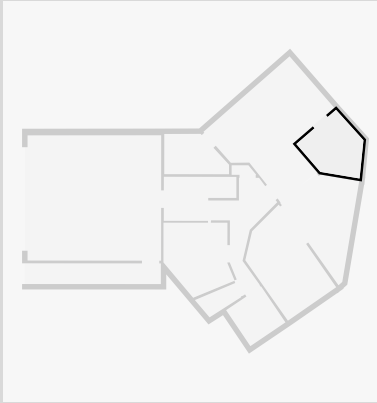

Closet

Width: 1.87 m
 Length: 3.00 m
 Area: 4.66 m²
 Perimeter: 8.92 m

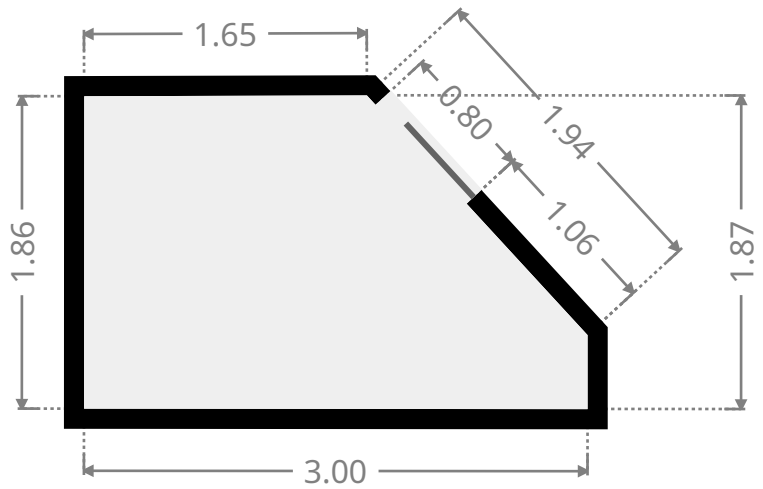
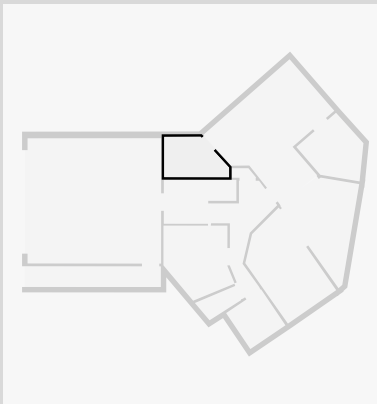

THIS FLOORPLAN IS PROVIDED WITHOUT WARRANTY OF ANY KIND. SENSOPIA DISCLAIMS ANY WARRANTY INCLUDING, WITHOUT LIMITATION, SATISFACTORY QUALITY OR ACCURACY OF DIMENSIONS.



12 Elida Street

Closet

| | |
|-----------|---------------------|
| Width: | 0.44 m |
| Length: | 1.14 m |
| Area | 0.42 m ² |
| Perimeter | 2.93 m |

