

Ground Floor

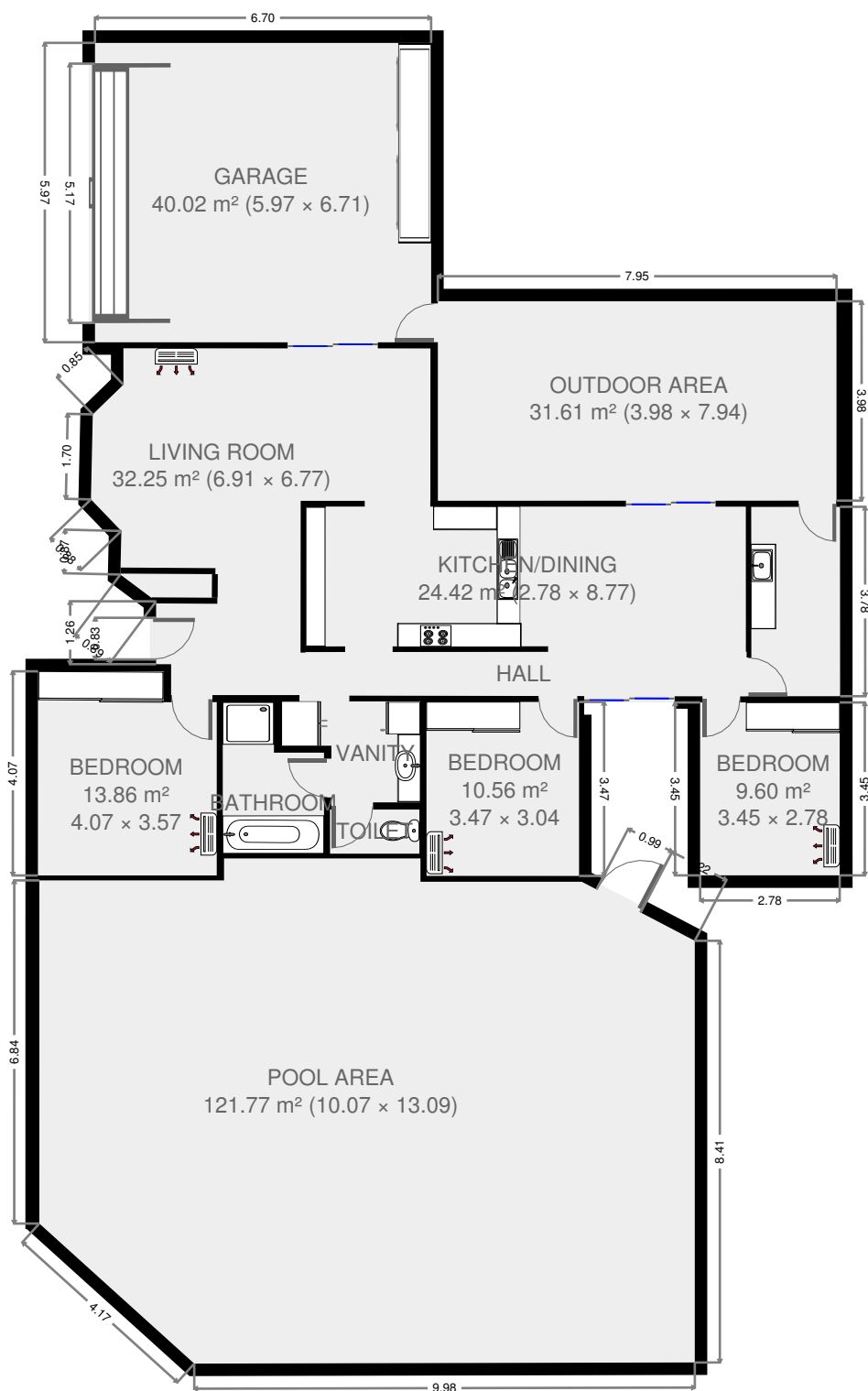

THIS FLOORPLAN IS PROVIDED WITHOUT WARRANTY OF ANY KIND. SENSOPIA DISCLAIMS ANY WARRANTY INCLUDING, WITHOUT LIMITATION, SATISFACTORY QUALITY OR ACCURACY OF DIMENSIONS.

12 Carrara Drive

Living Room

Width: 6.77 m
 Length: 6.91 m
 Area: 32.25 m²
 Perimeter: 26.28 m
 Ceiling Height: 2.17 m

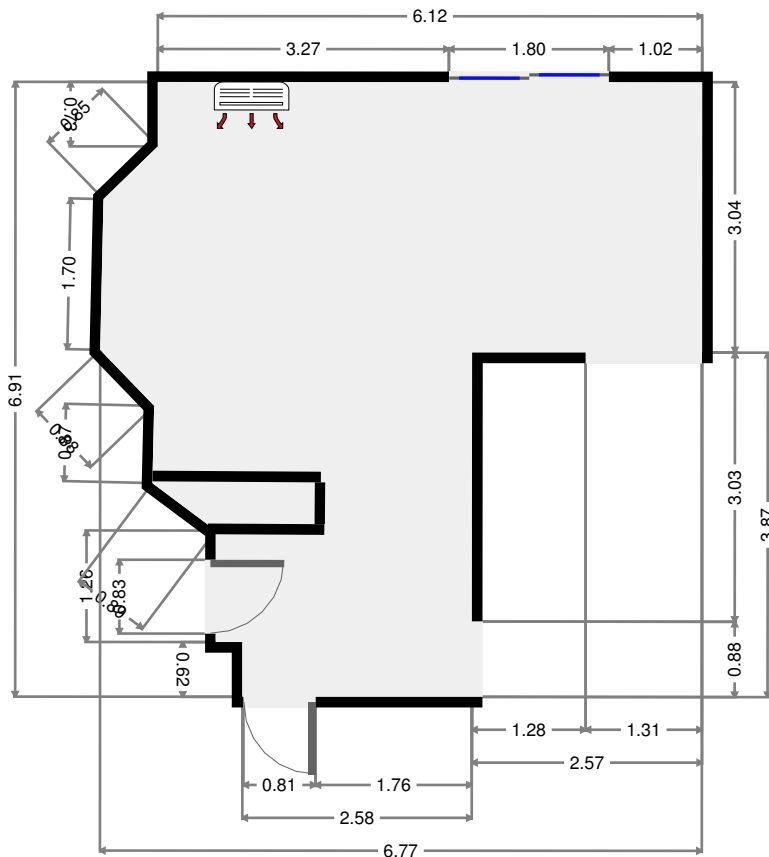

Bedroom

Width: 3.57 m
 Length: 4.07 m
 Area: 13.86 m²
 Perimeter: 15.28 m

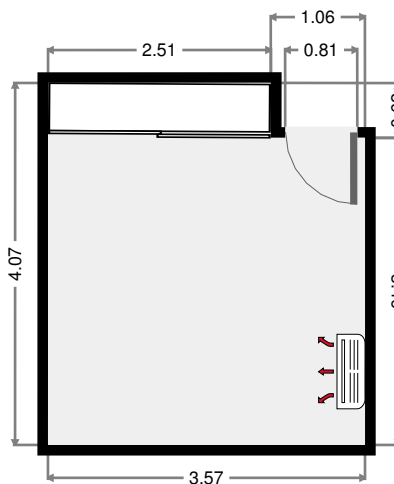
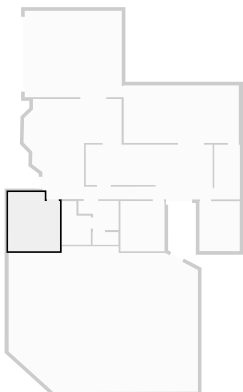

THIS FLOORPLAN IS PROVIDED WITHOUT WARRANTY OF ANY KIND. SENSOPIA DISCLAIMS ANY WARRANTY INCLUDING, WITHOUT LIMITATION, SATISFACTORY QUALITY OR ACCURACY OF DIMENSIONS.

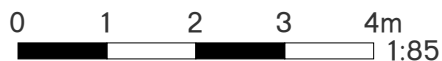

12 Carrara Drive

2017-02-28

Hall

Width: 0.90 m
 Length: 8.81 m
 Area: 7.73 m²
 Perimeter: 19.36 m

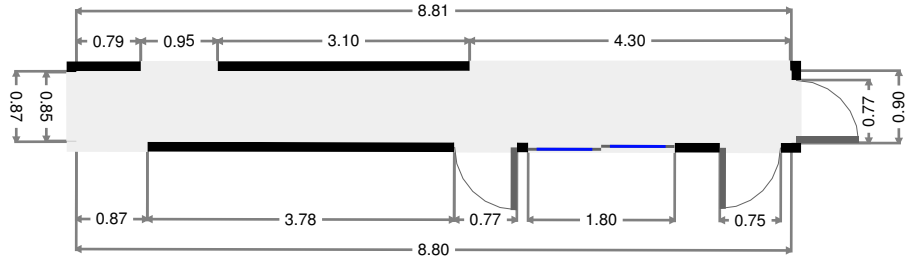

Kitchen/Dining

Width: 2.78 m
 Length: 8.77 m
 Area: 24.42 m²
 Perimeter: 23.11 m

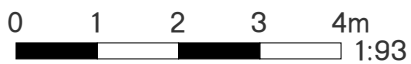
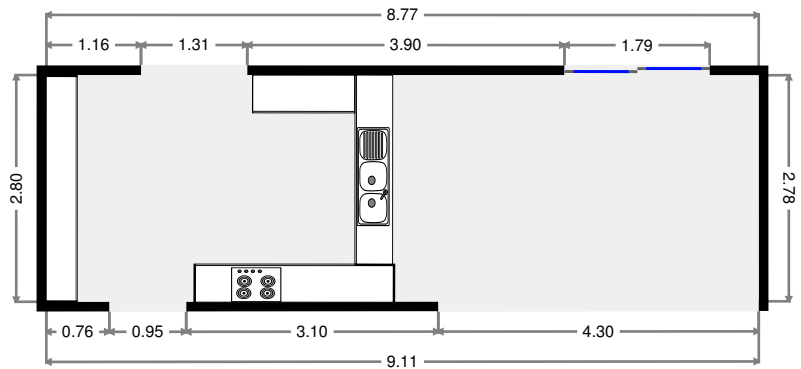
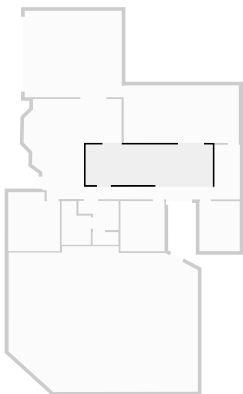

THIS FLOORPLAN IS PROVIDED WITHOUT WARRANTY OF ANY KIND. SENSOPIA DISCLAIMS ANY WARRANTY INCLUDING, WITHOUT LIMITATION, SATISFACTORY QUALITY OR ACCURACY OF DIMENSIONS.

Vanity

Width: 2.01 m
 Length: 2.77 m
 Area: 4.45 m²
 Perimeter: 9.57 m

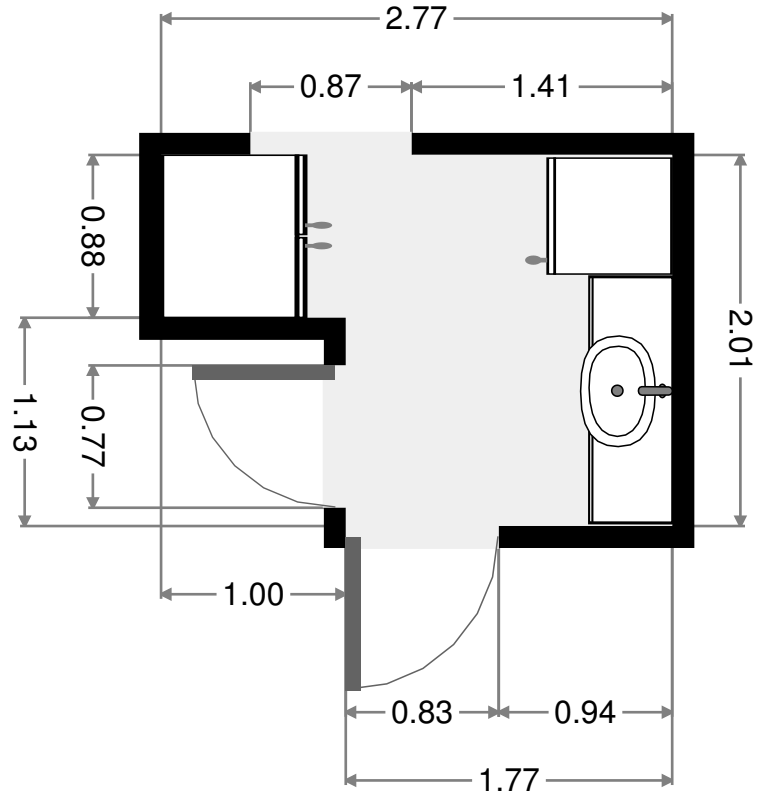
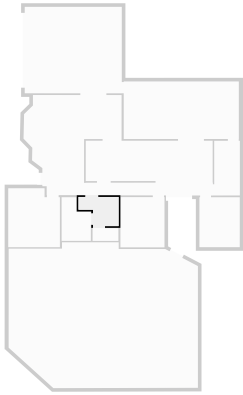

Toilet

Width: 0.88 m
 Length: 1.78 m
 Area: 1.57 m²
 Perimeter: 5.32 m

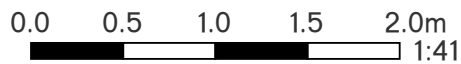
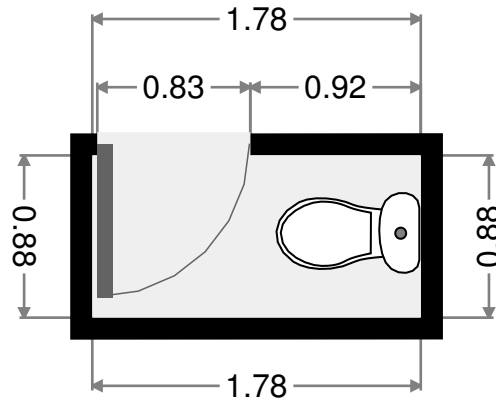
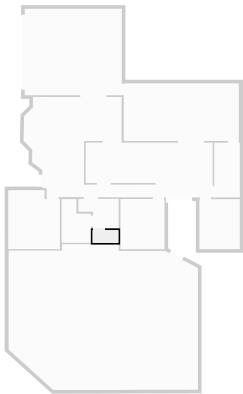

THIS FLOORPLAN IS PROVIDED WITHOUT WARRANTY OF ANY KIND. SENSOPIA DISCLAIMS ANY WARRANTY INCLUDING, WITHOUT LIMITATION, SATISFACTORY QUALITY OR ACCURACY OF DIMENSIONS.

Bathroom

Width: 2.02 m
 Length: 2.83 m
 Area: 5.08 m²
 Perimeter: 10.06 m

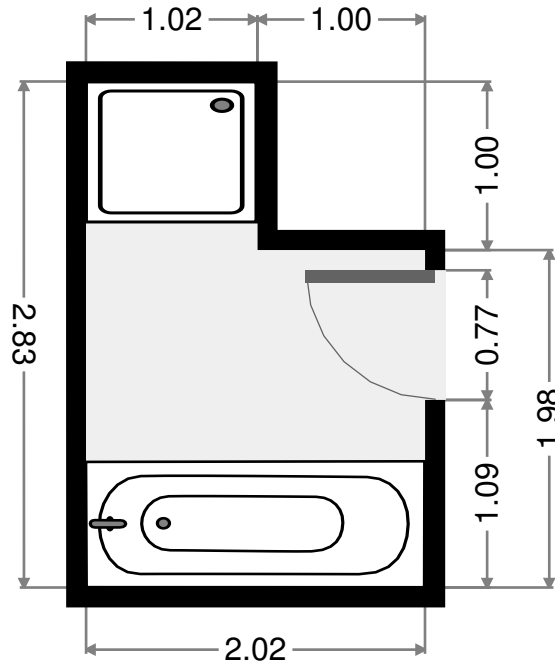
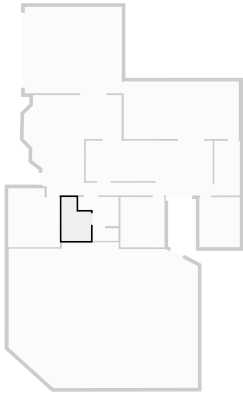

Bedroom

Width: 3.04 m
 Length: 3.47 m
 Area: 10.56 m²
 Perimeter: 13.02 m

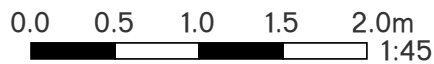
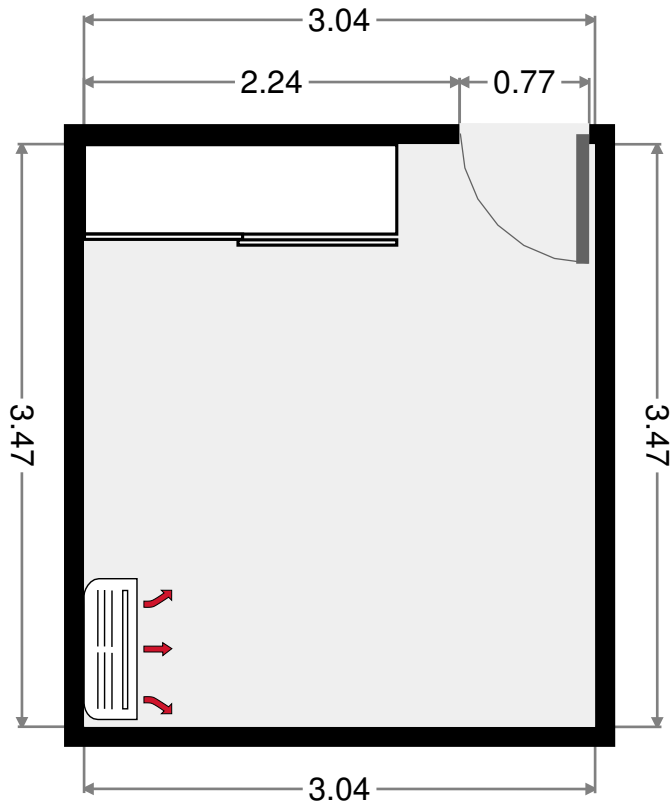
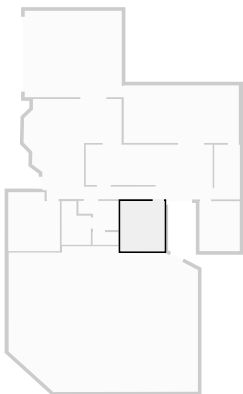

THIS FLOORPLAN IS PROVIDED WITHOUT WARRANTY OF ANY KIND. SENSOPIA DISCLAIMS ANY WARRANTY INCLUDING, WITHOUT LIMITATION, SATISFACTORY QUALITY OR ACCURACY OF DIMENSIONS.

Bedroom

Width: 2.78 m
 Length: 3.45 m
 Area: 9.60 m²
 Perimeter: 12.46 m

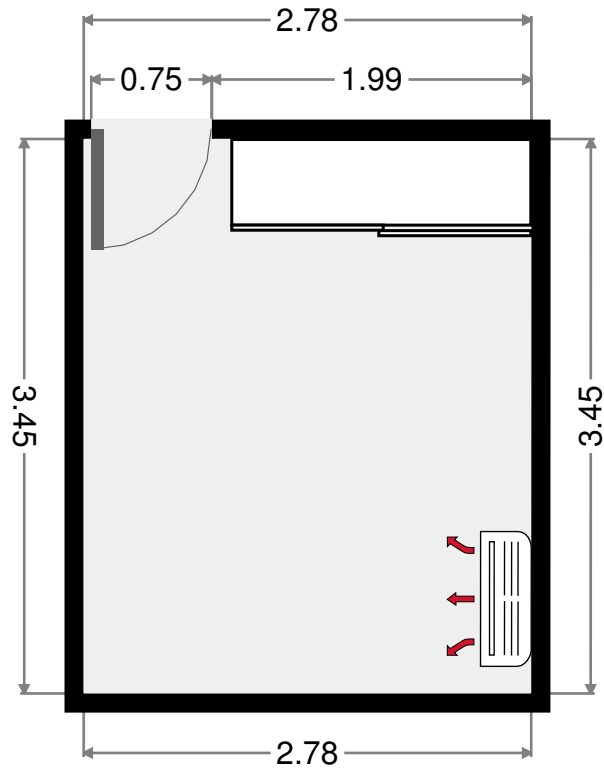
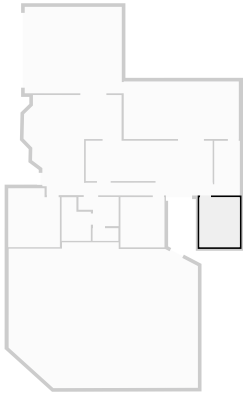

Laundry Room

Width: 1.78 m
 Length: 3.78 m
 Area: 6.68 m²
 Perimeter: 11.09 m

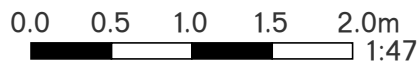
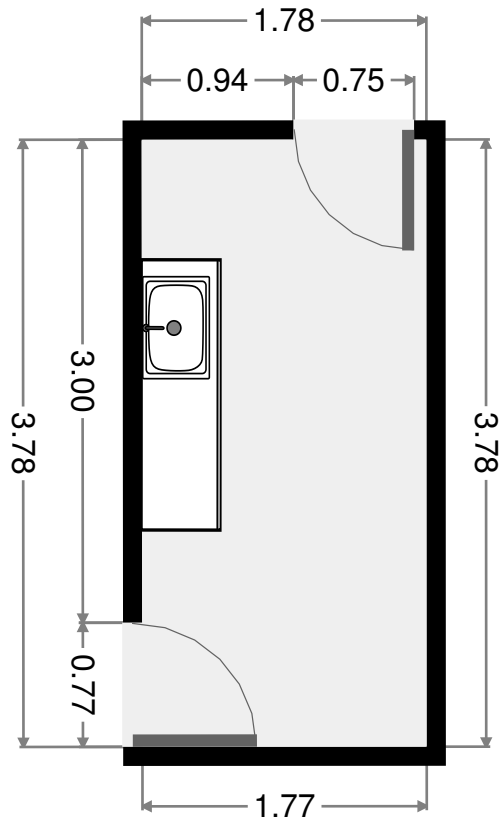
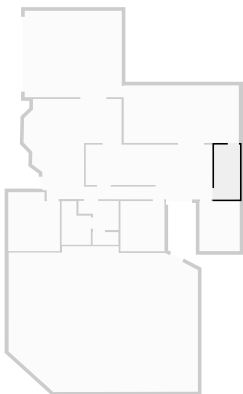

THIS FLOORPLAN IS PROVIDED WITHOUT WARRANTY OF ANY KIND. SENSOPIA DISCLAIMS ANY WARRANTY INCLUDING, WITHOUT LIMITATION, SATISFACTORY QUALITY OR ACCURACY OF DIMENSIONS.

Outdoor Area

Width: 3.98 m
 Length: 7.94 m
 Area: 31.61 m²
 Perimeter: 23.85 m

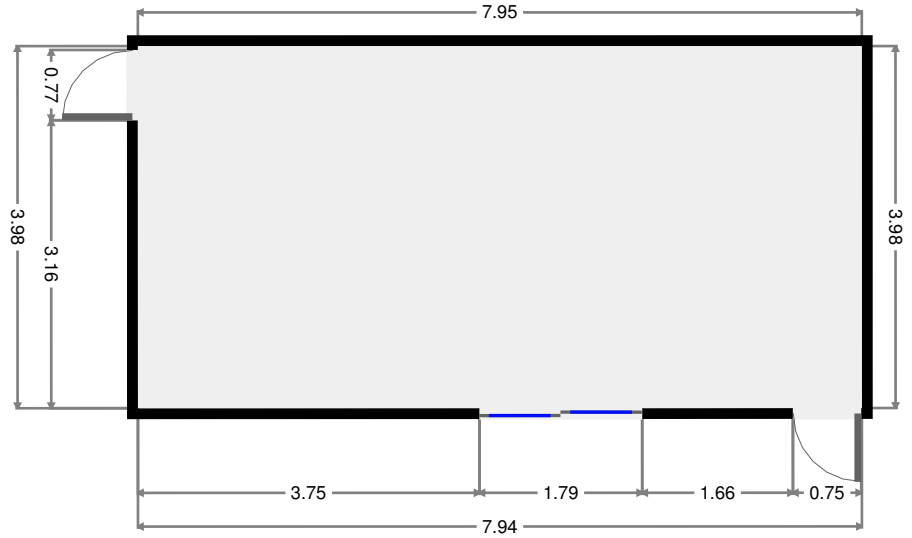
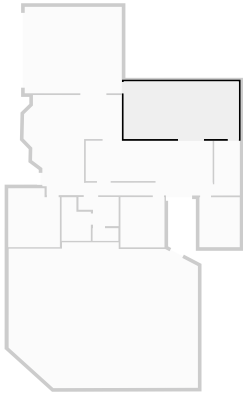

Garage

Width: 5.97 m
 Length: 6.71 m
 Area: 40.02 m²
 Perimeter: 25.35 m

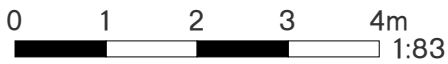
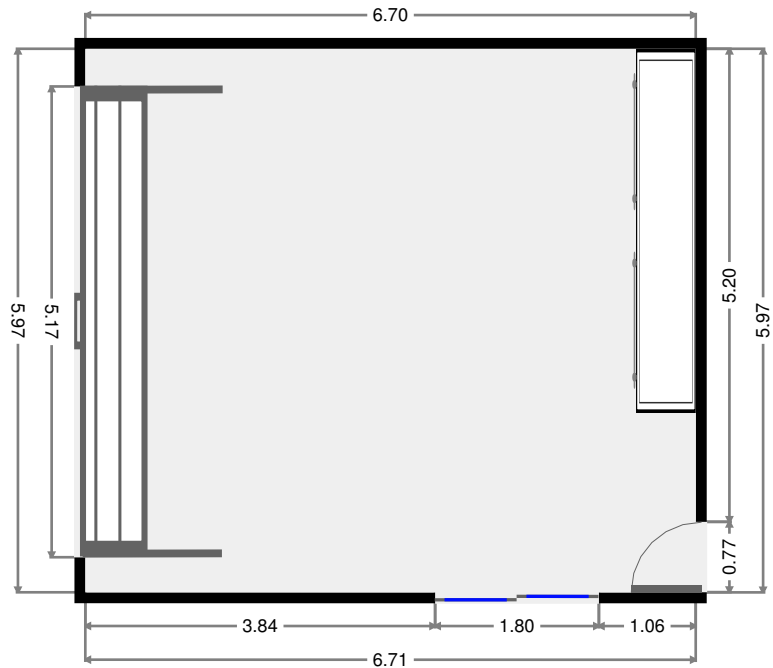
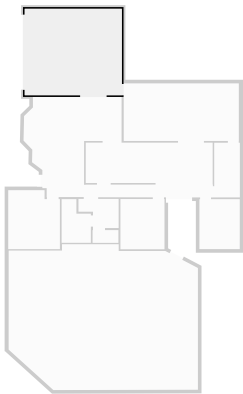

THIS FLOORPLAN IS PROVIDED WITHOUT WARRANTY OF ANY KIND. SENSOPIA DISCLAIMS ANY WARRANTY INCLUDING, WITHOUT LIMITATION, SATISFACTORY QUALITY OR ACCURACY OF DIMENSIONS.

Pool Area

Width: 10.07 m
Length: 13.09 m
Area: 121.77 m²
Perimeter: 43.66 m
Ceiling Height: 2.17 m

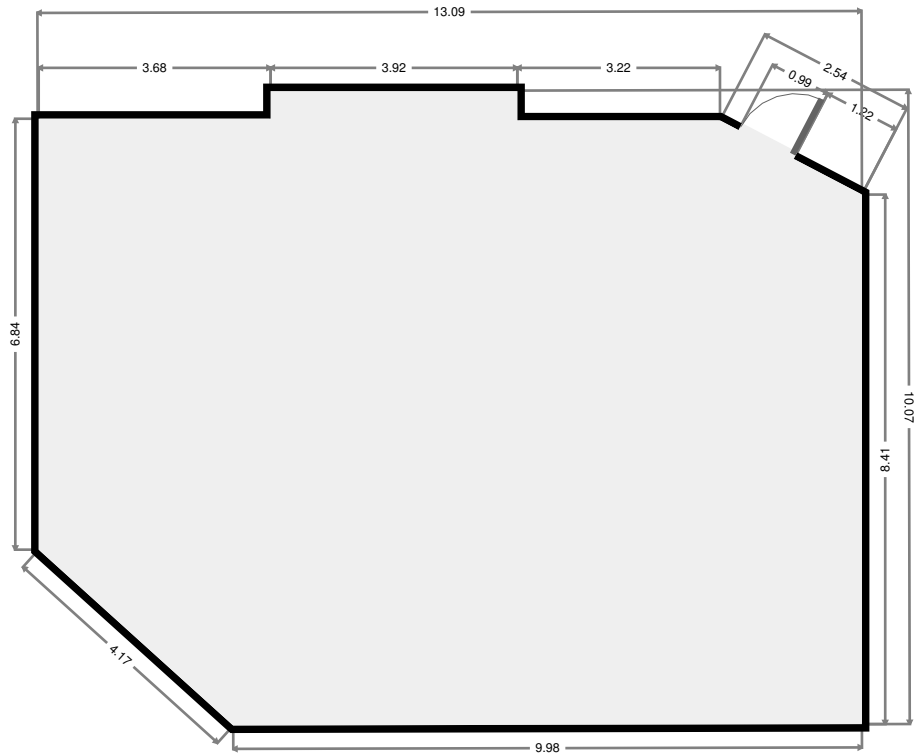
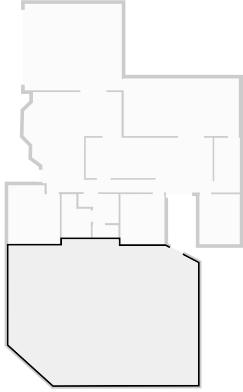

THIS FLOORPLAN IS PROVIDED WITHOUT WARRANTY OF ANY KIND. SENSOPIA DISCLAIMS ANY WARRANTY INCLUDING, WITHOUT LIMITATION, SATISFACTORY QUALITY OR ACCURACY OF DIMENSIONS.

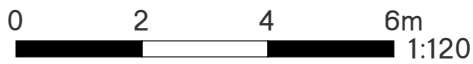

12 Carrara Drive

2017-02-28