

# 12 Arnold Street

## Ground Floor

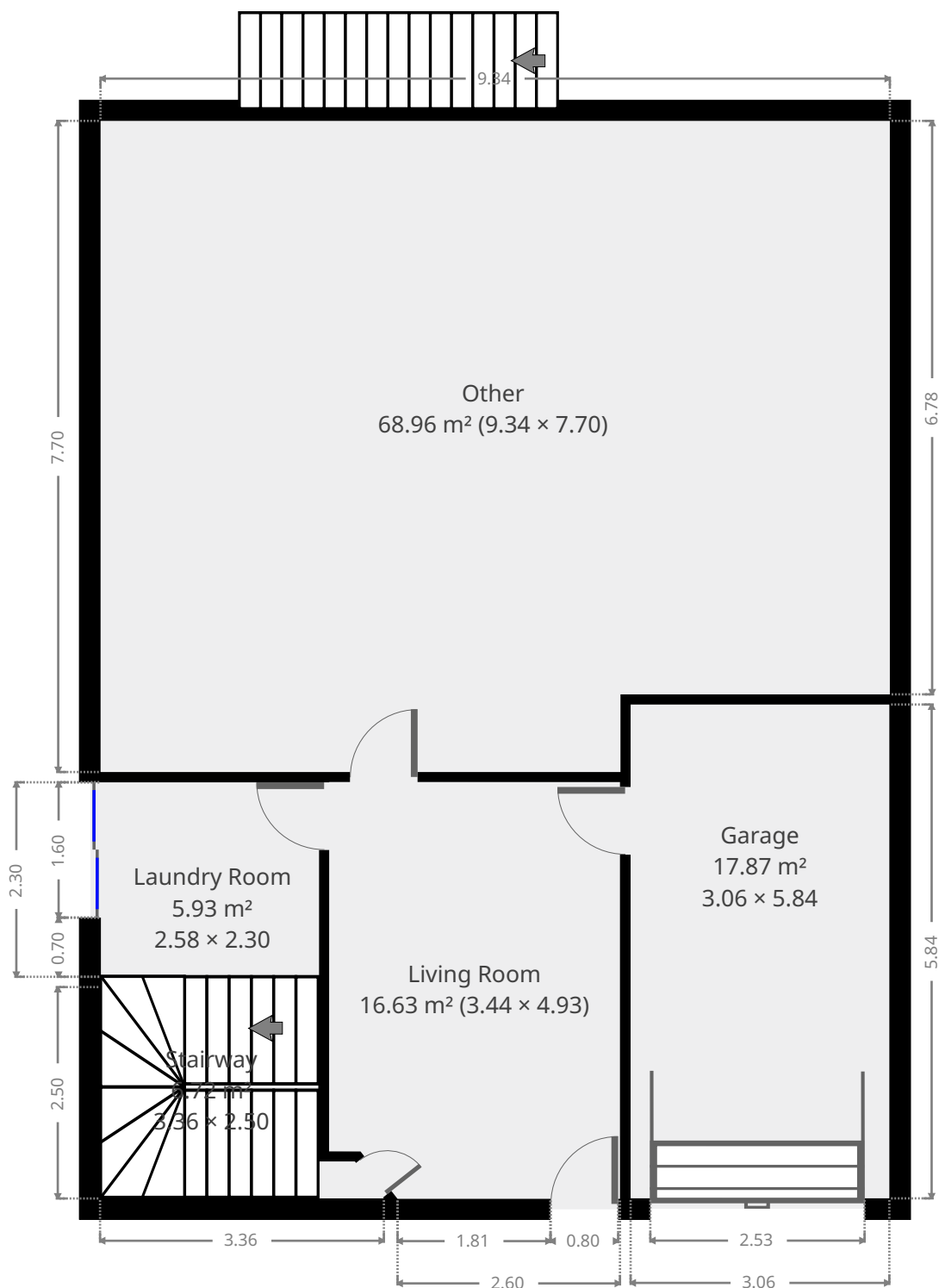

THIS FLOORPLAN IS PROVIDED WITHOUT WARRANTY OF ANY KIND. SENSOPIA DISCLAIMS ANY WARRANTY INCLUDING, WITHOUT LIMITATION, SATISFACTORY QUALITY OR ACCURACY OF DIMENSIONS.

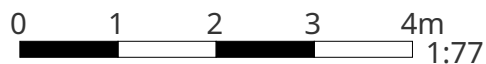

# 12 Arnold Street

## Living Room

Width: 3.44 m  
Length: 4.93 m  
Area: 16.63 m<sup>2</sup>  
Perimeter: 16.45 m

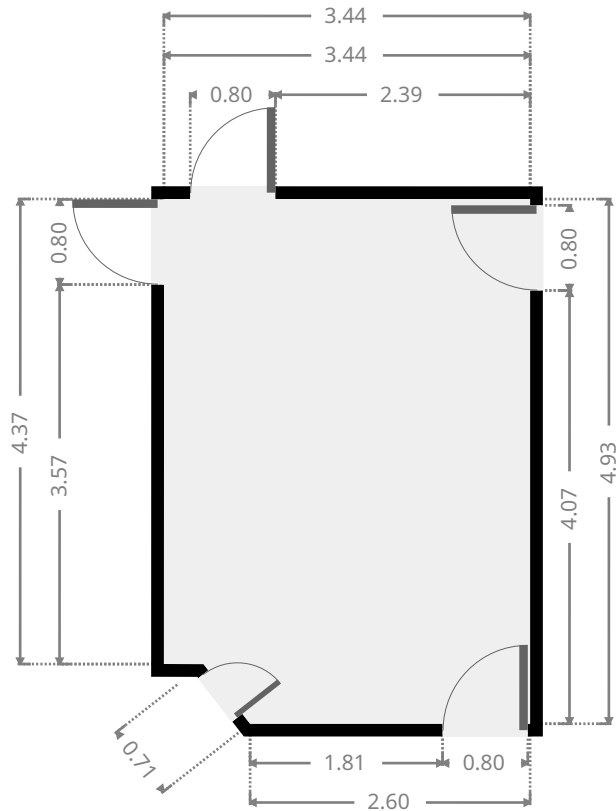
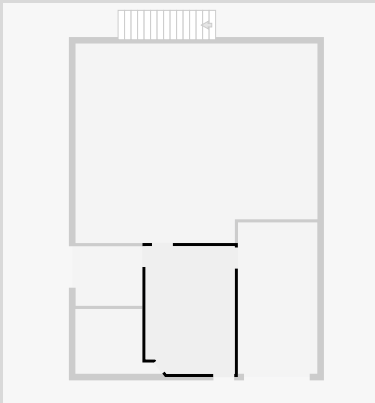

## Stairway

Width: 2.50 m  
Length: 3.36 m  
Area: 6.72 m<sup>2</sup>  
Perimeter: 11.49 m

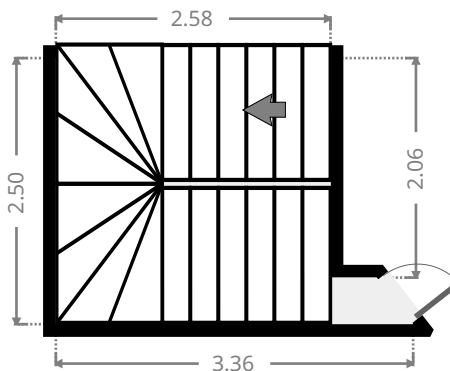
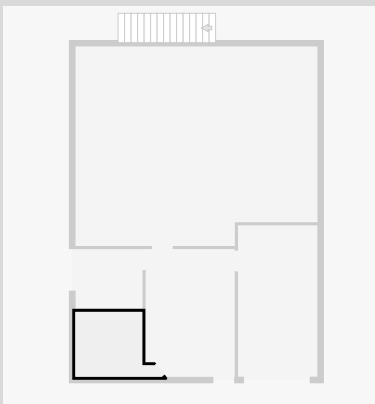

THIS FLOORPLAN IS PROVIDED WITHOUT WARRANTY OF ANY KIND. SENSOPIA DISCLAIMS ANY WARRANTY INCLUDING, WITHOUT LIMITATION, SATISFACTORY QUALITY OR ACCURACY OF DIMENSIONS.

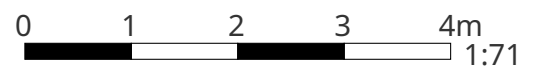

# 12 Arnold Street

## Garage

Width: 3.06 m  
Length: 5.84 m  
Area: 17.87 m<sup>2</sup>  
Perimeter: 17.80 m

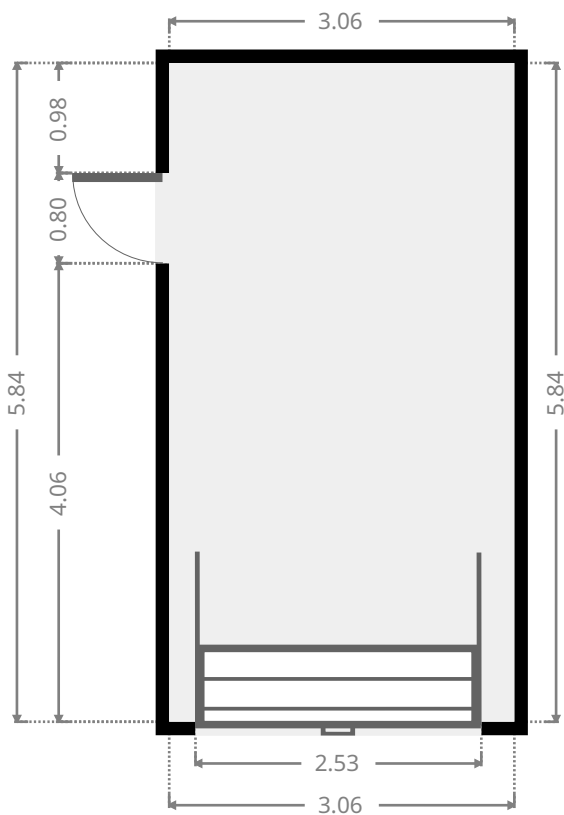
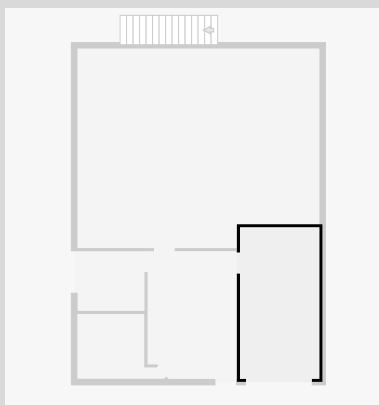

## Laundry Room

Width: 2.30 m  
Length: 2.58 m  
Area: 5.93 m<sup>2</sup>  
Perimeter: 9.76 m

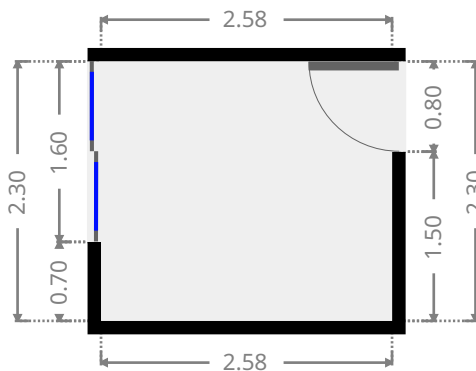
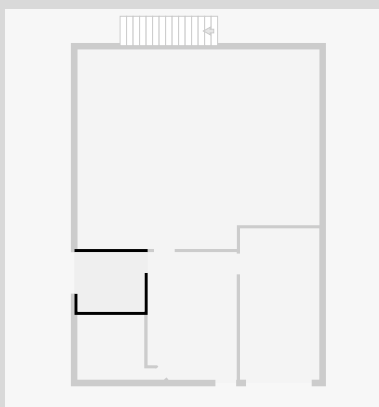

# 12 Arnold Street

## Other

Width: 7.70 m  
Length: 9.34 m  
Area: 68.96 m<sup>2</sup>  
Perimeter: 34.07 m

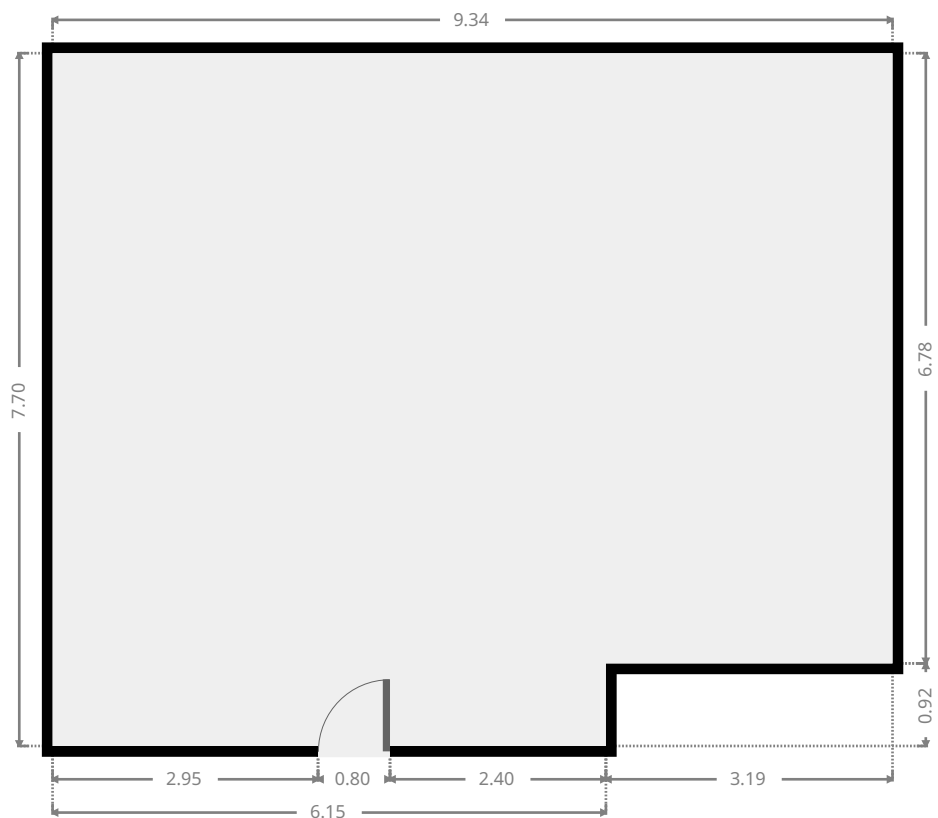
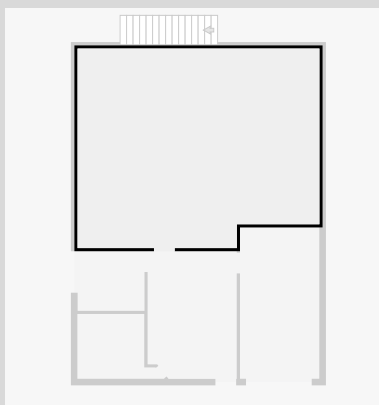

THIS FLOORPLAN IS PROVIDED WITHOUT WARRANTY OF ANY KIND. SENSOPIA DISCLAIMS ANY WARRANTY INCLUDING, WITHOUT LIMITATION, SATISFACTORY QUALITY OR ACCURACY OF DIMENSIONS.

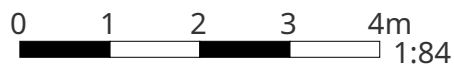

# 12 Arnold Street

## 1st Floor

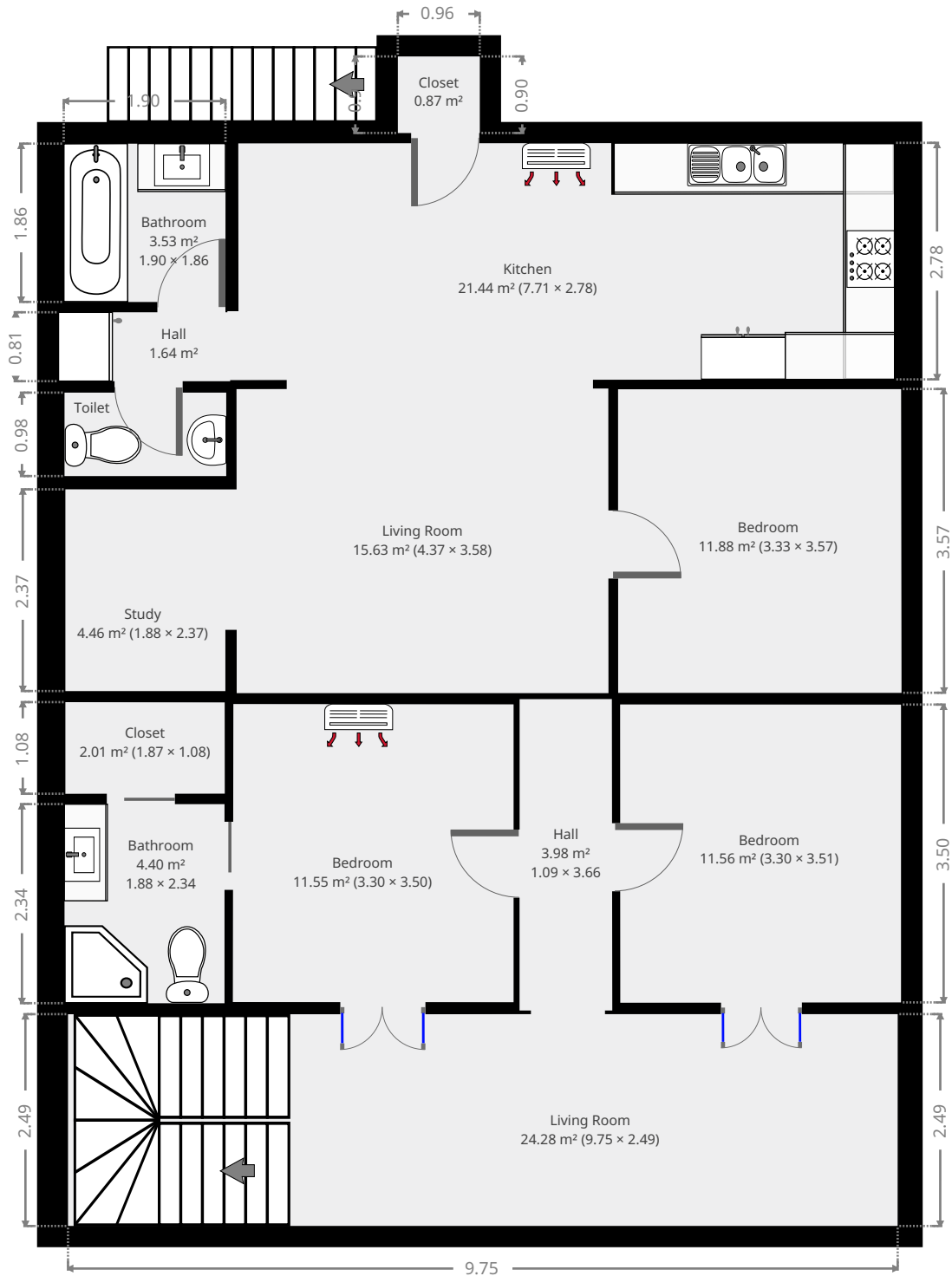

THIS FLOORPLAN IS PROVIDED WITHOUT WARRANTY OF ANY KIND. SENSOPIA DISCLAIMS ANY WARRANTY INCLUDING, WITHOUT LIMITATION, SATISFACTORY QUALITY OR ACCURACY OF DIMENSIONS.



# 12 Arnold Street

## Living Room

Width: 2.49 m  
 Length: 9.75 m  
 Area: 24.28 m<sup>2</sup>  
 Perimeter: 24.48 m

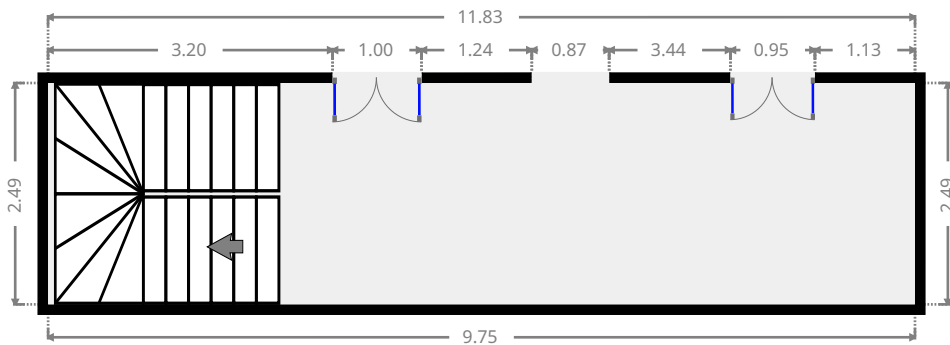
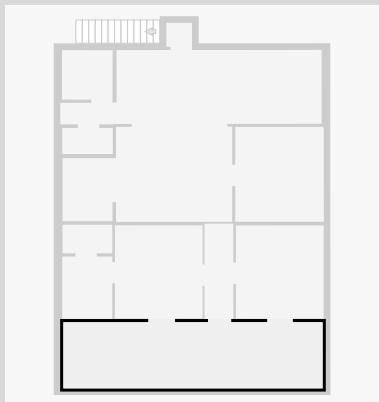

## Hall

Width: 1.09 m  
 Length: 3.66 m  
 Area: 3.98 m<sup>2</sup>  
 Perimeter: 9.49 m

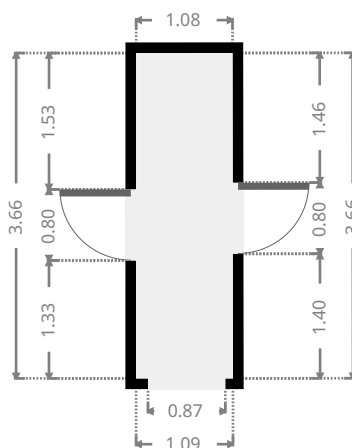
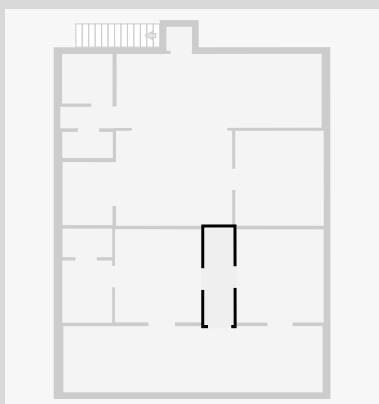

THIS FLOORPLAN IS PROVIDED WITHOUT WARRANTY OF ANY KIND. SENSOPIA DISCLAIMS ANY WARRANTY INCLUDING, WITHOUT LIMITATION, SATISFACTORY QUALITY OR ACCURACY OF DIMENSIONS.

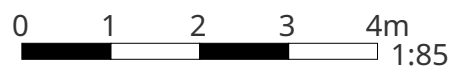

# 12 Arnold Street

## Bedroom

Width: 3.30 m  
 Length: 3.51 m  
 Area: 11.56 m<sup>2</sup>  
 Perimeter: 13.61 m

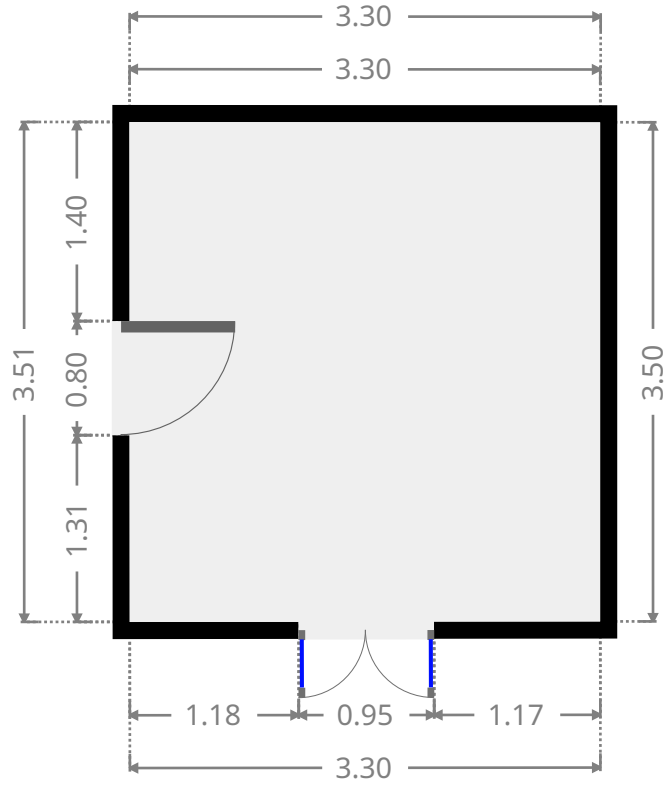
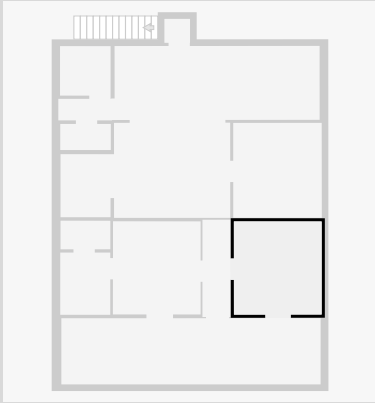

## Bedroom

Width: 3.30 m  
 Length: 3.50 m  
 Area: 11.55 m<sup>2</sup>  
 Perimeter: 13.60 m

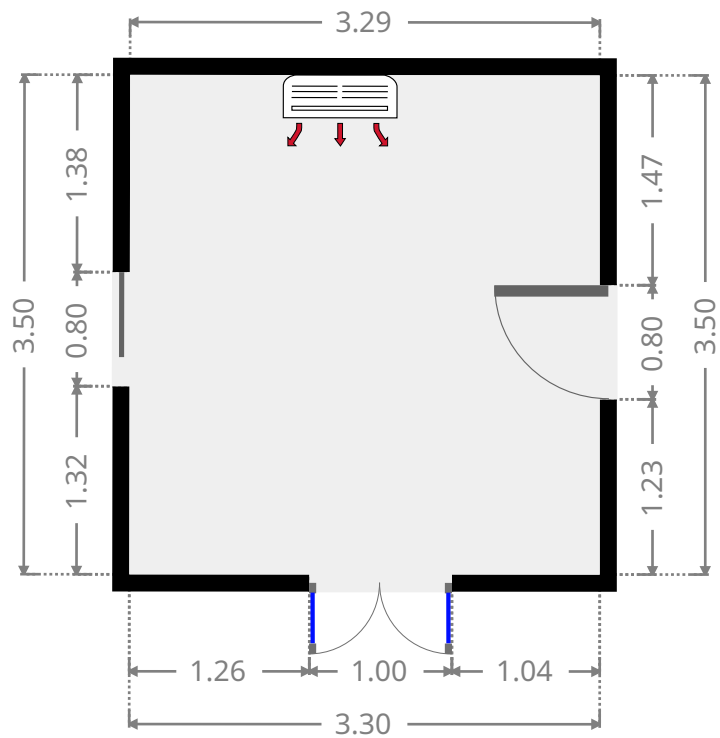
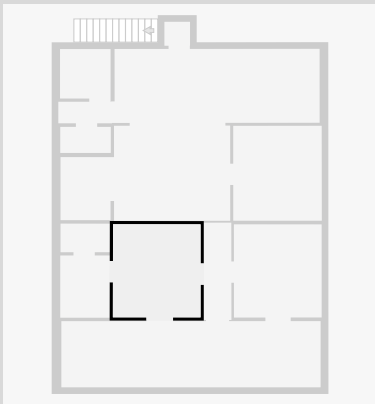

THIS FLOORPLAN IS PROVIDED WITHOUT WARRANTY OF ANY KIND. SENSOPIA DISCLAIMS ANY WARRANTY INCLUDING, WITHOUT LIMITATION, SATISFACTORY QUALITY OR ACCURACY OF DIMENSIONS.

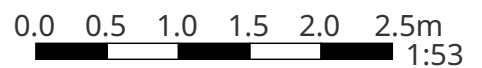

# 12 Arnold Street

## Bathroom

Width: 1.88 m  
Length: 2.34 m  
Area: 4.40 m<sup>2</sup>  
Perimeter: 8.44 m

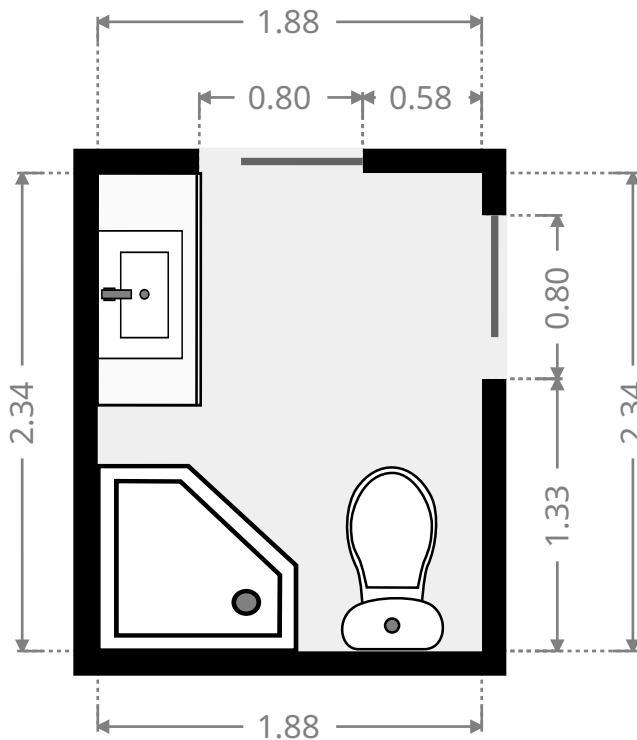
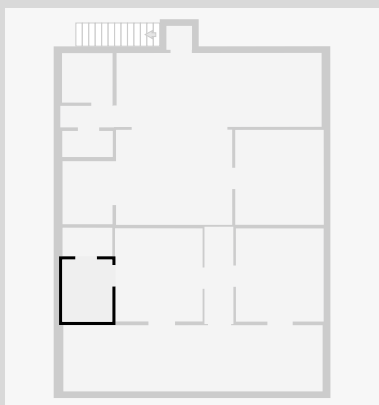

## Closet

Width: 1.08 m  
Length: 1.87 m  
Area: 2.01 m<sup>2</sup>  
Perimeter: 5.90 m

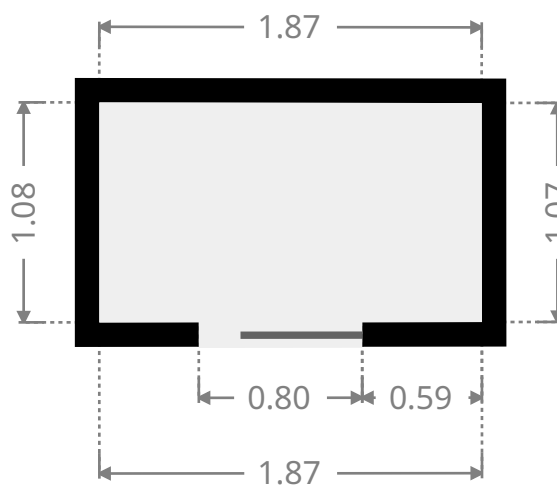
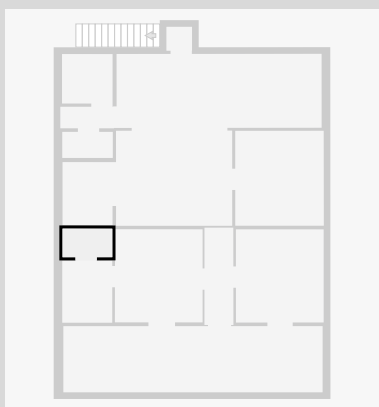

THIS FLOORPLAN IS PROVIDED WITHOUT WARRANTY OF ANY KIND. SENSOPIA DISCLAIMS ANY WARRANTY INCLUDING, WITHOUT LIMITATION, SATISFACTORY QUALITY OR ACCURACY OF DIMENSIONS.

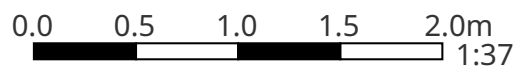



# 12 Arnold Street

## Bedroom

Width: 3.33 m  
 Length: 3.57 m  
 Area: 11.88 m<sup>2</sup>  
 Perimeter: 13.80 m

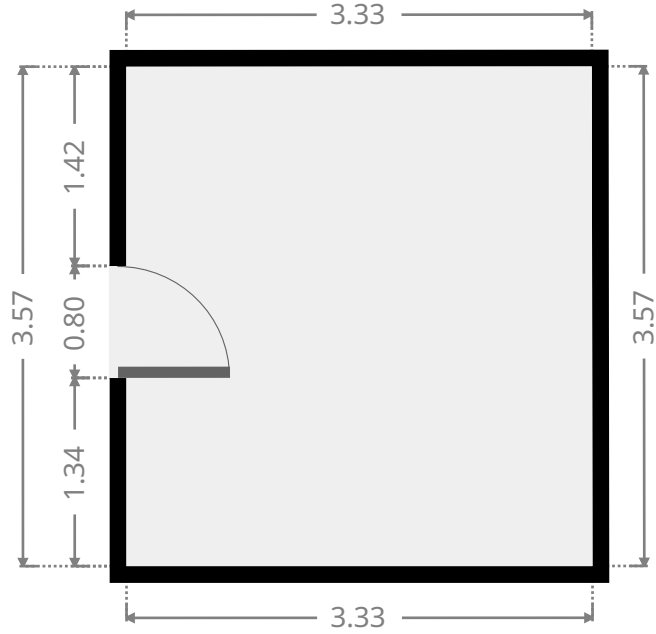
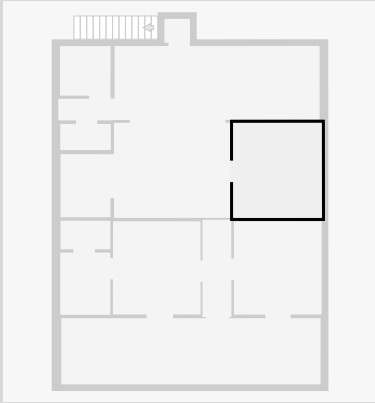

## Living Room

Width: 3.58 m  
 Length: 4.37 m  
 Area: 15.63 m<sup>2</sup>  
 Perimeter: 15.89 m

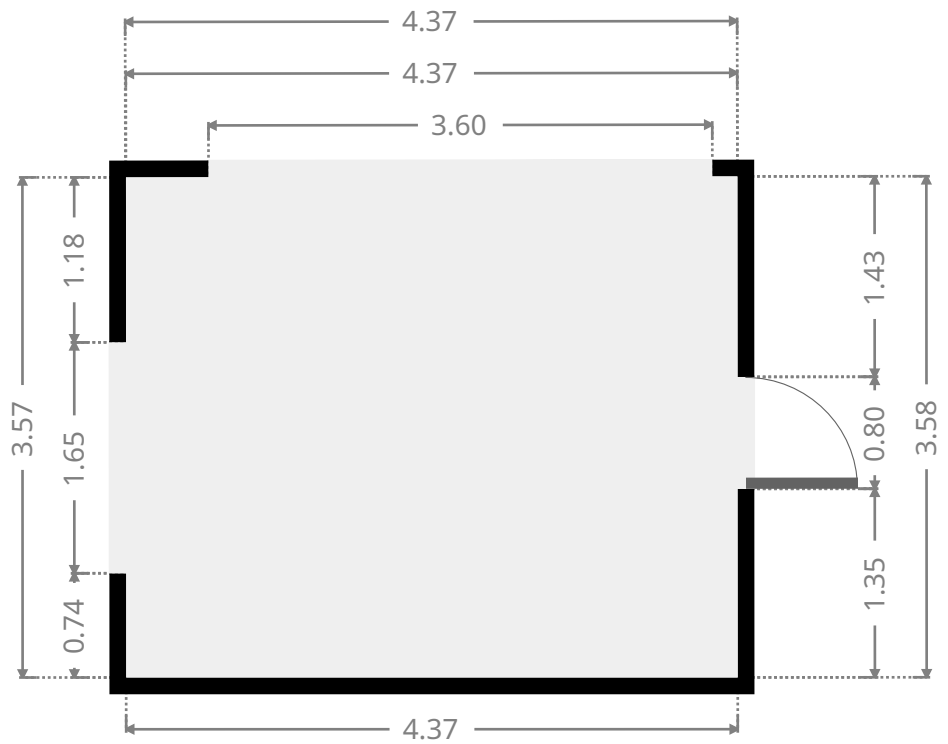
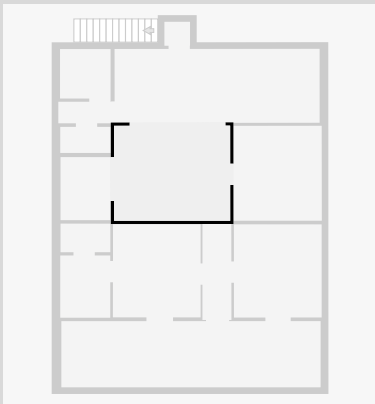

THIS FLOORPLAN IS PROVIDED WITHOUT WARRANTY OF ANY KIND. SENSOPIA DISCLAIMS ANY WARRANTY INCLUDING, WITHOUT LIMITATION, SATISFACTORY QUALITY OR ACCURACY OF DIMENSIONS.

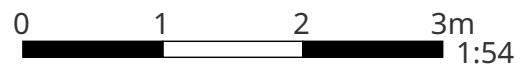

# 12 Arnold Street

## Study

Width: 1.88 m  
Length: 2.37 m  
Area: 4.46 m<sup>2</sup>  
Perimeter: 8.50 m

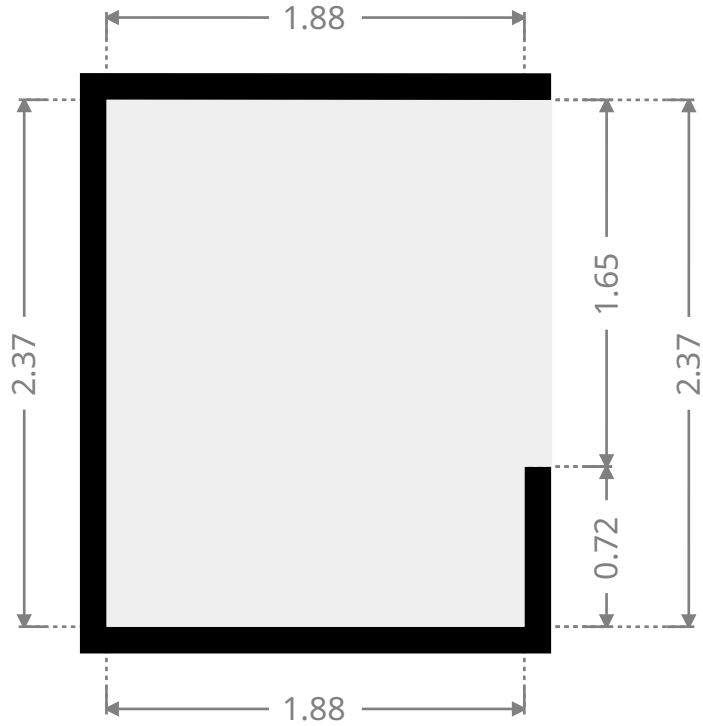
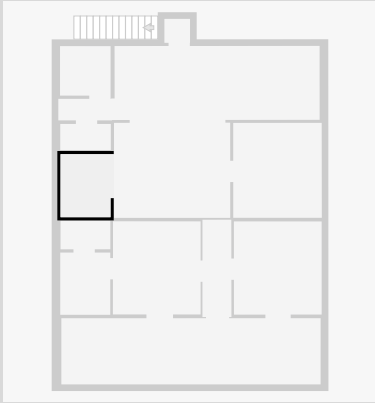

## Toilet / Half Bath

Width: 0.98 m  
Length: 1.90 m  
Area: 1.86 m<sup>2</sup>  
Perimeter: 5.76 m

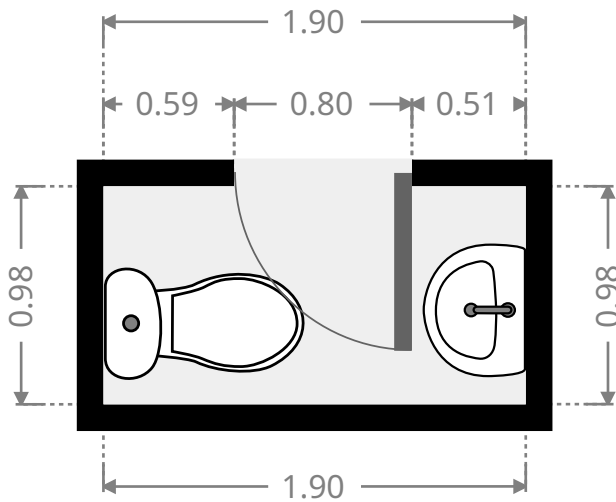
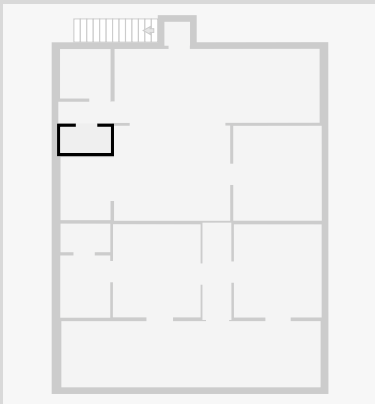

# 12 Arnold Street

## Hall

Width: 0.81 m  
Length: 2.02 m  
Area: 1.64 m<sup>2</sup>  
Perimeter: 5.66 m

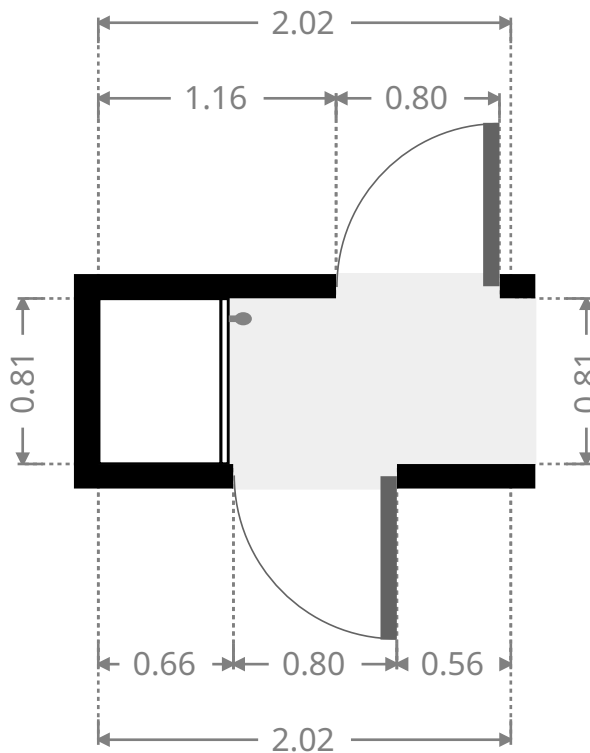
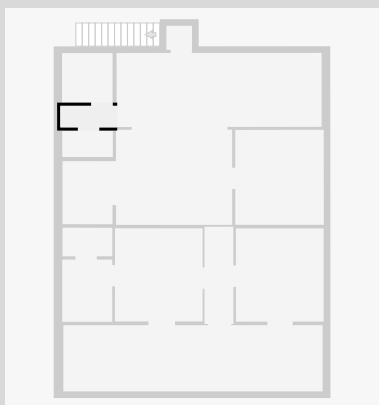

## Bathroom

Width: 1.86 m  
Length: 1.90 m  
Area: 3.53 m<sup>2</sup>  
Perimeter: 7.52 m

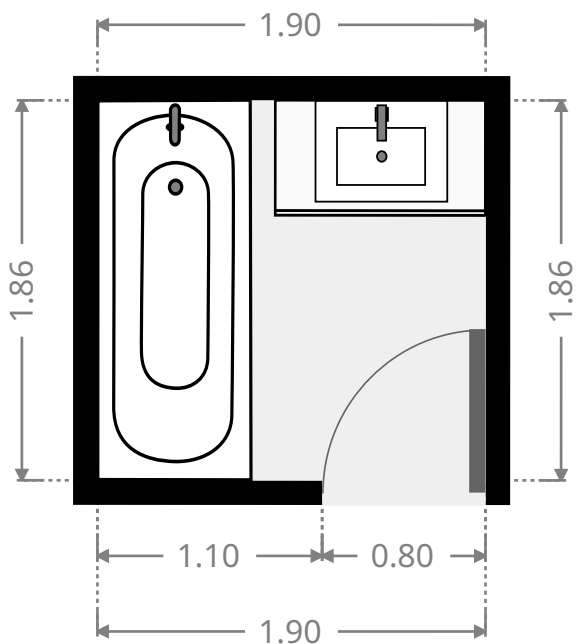
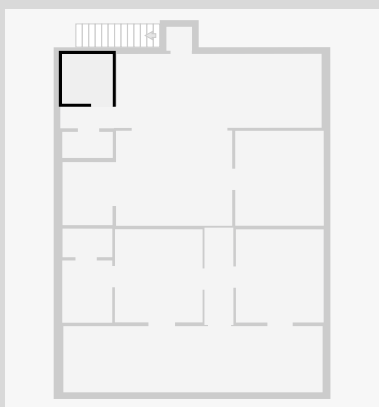

THIS FLOORPLAN IS PROVIDED WITHOUT WARRANTY OF ANY KIND. SENSOPIA DISCLAIMS ANY WARRANTY INCLUDING, WITHOUT LIMITATION, SATISFACTORY QUALITY OR ACCURACY OF DIMENSIONS.

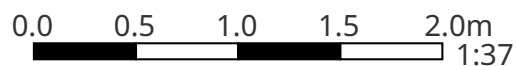

# 12 Arnold Street

## Kitchen

Width: 2.78 m  
 Length: 7.71 m  
 Area: 21.44 m<sup>2</sup>  
 Perimeter: 20.98 m

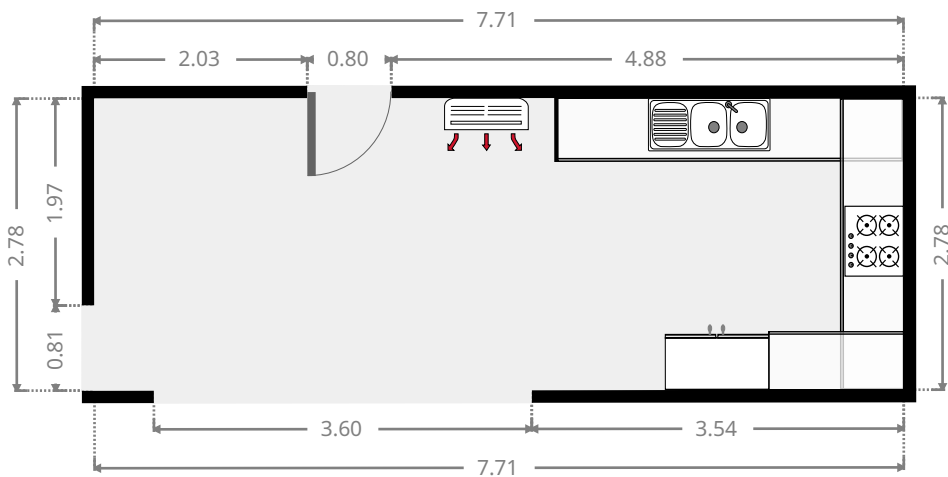
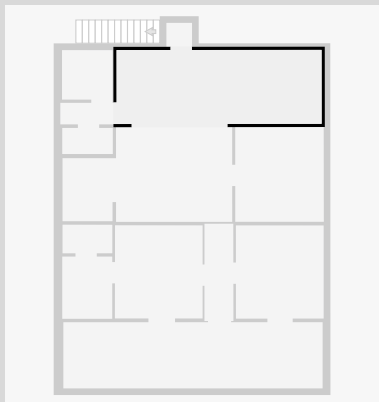

## Closet

Width: 0.90 m  
 Length: 0.96 m  
 Area: 0.87 m<sup>2</sup>  
 Perimeter: 3.72 m

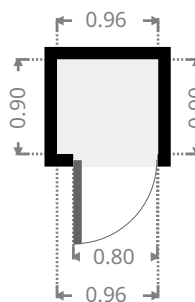
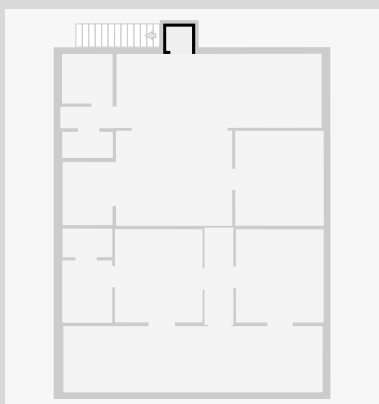

THIS FLOORPLAN IS PROVIDED WITHOUT WARRANTY OF ANY KIND. SENSOPIA DISCLAIMS ANY WARRANTY INCLUDING, WITHOUT LIMITATION, SATISFACTORY QUALITY OR ACCURACY OF DIMENSIONS.

